

welch

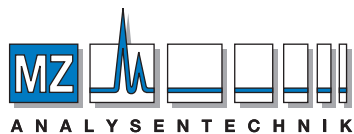

AUTHORIZED DISTRIBUTOR

MZ-Analysentechnik GmbH, Barcelona-Allee 17• D-55129 Mainz
Tel +49 6131 880 96-0, Fax +49 6131 880 96-20
e-mail: info@mz-at.de, www.mz-at.de

2016/2017

CHROMATOGRAPHY
PRODUCTS CATALOG



Welch Materials, Inc.

HPLC Column, Preparative Column, Flash Column, GC Column,
Packing Materials, SPE, QuEChERS, HPLC Instrument



Quality, Innovation, Competitive Price

Welch Materials develops and manufactures chromatography consumables including HPLC columns, Solid Phase Extraction (SPE) columns, GC columns, sample vials, syringe filters, and chromatographic media.

Welch Materials (Shanghai), Inc. was established in 2003 at Shanghai, China and Welch Materials (Zhejiang) was formed in 2011 at Jinhua, Zhejiang, China. Our core strength was our extensive experience in particle surface modification science and techniques. We are experts in bonding chemistry and innovative packing materials for chromatography applications. By fully utilizing our resources, we have developed many innovative LC and GC consumable products, and in particular, our five series HPLC columns: Ultisil™, Xtimate®, Welchrom®, Topsil® and Boltimate™ series.



Contents

HPLC Column	04
Ghost-Buster Column	04
Ultisil™ Bio-UHPLC Column	06
Boltimate™ Core-Shell HPLC Column	08
Ultisil™ Series HPLC Column	12
Xtimate® Series HPLC Column	46
Topsil® Series HPLC Column	54
Welchrom® Series HPLC Column	57
Preparative Column	58
Preparative HPLC Column	58
Flash Column	62
Guard Column & Pre-Column	66
GC Column	68
Packing Materials	73
Sample Preparation	76
Welchrom® SPE	76
Welchrom® QuEChERS	84
HPLC Instrument	87
Appendix	88

Ghost-Buster Column

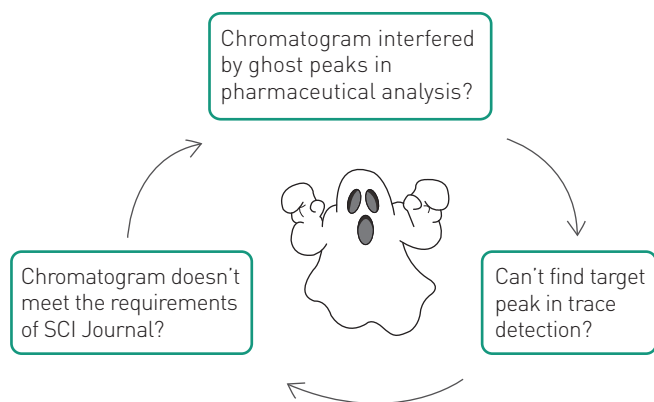

In HPLC analysis, especially in gradient elution, some unexpected peaks, which are usually called Ghost Peaks, may appear in a chromatogram.

There are several reasons for the appearance of ghost peaks, including residual in injector, water impurities and unknown components in sample. But in general, they are caused by impurities from the mobile phase.

Welch Ghost-Buster column can solve these problems easily!

Welch Ghost-Buster column can efficiently adsorb and remove the impurities from the mobile phase to eliminate their interference to the target peaks.

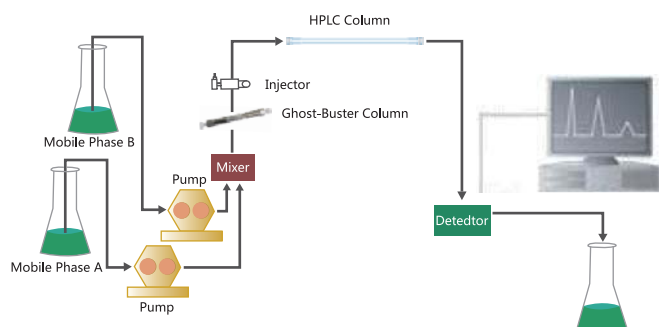

Installed between the gradient mixer and the sampler, Ghost-Buster column can trap most ghost peaks before HPLC analysis.

Example 1:

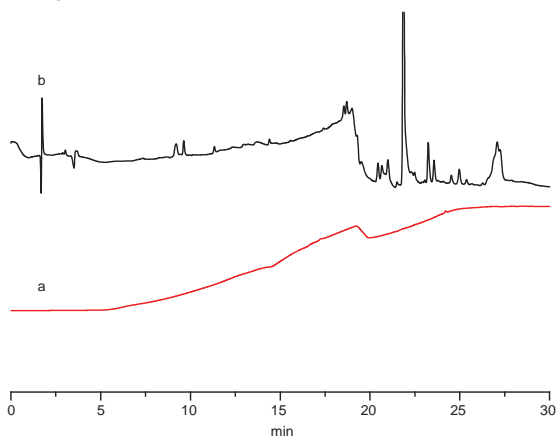

Figure 1. Chromatograms without Ghost-Buster column (b) and with Ghost-Buster column (4.6×50 mm) (a)

Column:	Ultisil™ XB-C18, 4.6×250 mm, 5 μm		
Flow Rate:	1.0 ml/min		
Injection Volume:	10 μl		
Detector:	210 nm		
Temperature:	40 °C		
Sample Preparation Solution:	ultrapure water		
Mobile Phase A:	ultrapure water		
Mobile Phase B:	acetonitrile		
Gradient Program:	Time (min)	A (%)	B (%)
	0	90	10
	20	10	90
	30	10	90
	30.1	90	10
	38	90	10

Example 2:

Figure 2. Chromatograms without Ghost-Buster column (b) and with Ghost-Buster column (4.6×50 mm) (a)

Column:	Ultisil™ XB-C18, 4.6×250 mm, 5 μm		
Flow Rate:	1.0 ml/min		
Injection Volume:	20 μl		
Detector:	280 nm		
Temperature:	40 °C		
Sample Preparation Solution:	ultrapure water		
Mobile Phase A:	1.54 g/l ammonium acetate, adjust pH to 4.0 with glacial acetic acid		
Mobile Phase B:	acetonitrile		
Gradient Program:	Time (min)	A (%)	B (%)
	0	98	2
	10	80	20
	20	40	60
	35	20	80
	40	20	80
	50	98	2

Example 3:

Figure 3. Chromatograms without Ghost-Buster column (b) and with Ghost-Buster column (4.6×50 mm) (a)

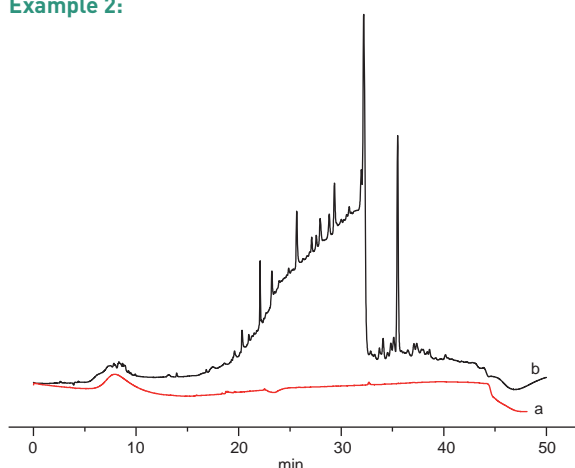
Column:	Ultisil™ XB-C18, 4.6×150 mm, 3 μm		
Flow Rate:	1.0 ml/min		
Injection Volume:	20 μl		
Detector:	254 nm		
Temperature:	30 °C		
Sample Preparation Solution:	ultrapure water		
Mobile Phase A:	20 mmol/l diammonium phosphate solution, adjust pH to 6.0 with phosphoric acid		
Mobile Phase B:	acetonitrile		
Gradient Program:	Time (min)	A (%)	B (%)
	0	85	15
	30	45	55
	30.1	85	15
	40	85	15

From Figures 1–3, one can observe that Welch Ghost-Buster column effectively eliminates impurities in the mobile phase.

Ordering Information

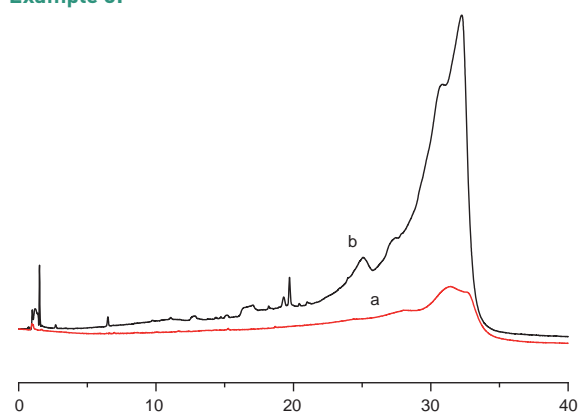
Item	P/N	Dimension	Maximum Pressure	Application Equipment
Ghost-Buster Column	06100-31000	4.6×50 mm	40 Mpa	HPLC
Ghost-Buster Column	06100-31001	7.8×50 mm	40 Mpa	HPLC
Ghost-Buster HP Column	06100-31021	2.1×33 mm	100 Mpa	UHPLC
Ghost-Buster HP Column	06100-31025	2.1×50 mm	100 Mpa	UHPLC

Notes:

1. It should be noted that not all impurities can be removed from the mobile phase.
2. Ghost-Buster column is installed between the gradient mixer and the sampler. If it is installed like a guard column, target peaks may disappear.
3. If ion-pairing reagents are used in the analysis, it is possible that the reagents may be retained by the Ghost-Buster column, impacting the analysis' retention time and peak shape.
4. It is not recommended to flush the Ghost-Buster column with 100% water for a long time.
5. Ghost-Buster column's service life differs by analysis conditions, mobile phase and its purity. New column is recommended when result is not ideal.

Ultisil™ Bio-UHPLC Column

Why Biocompatible Column?

HPLC column hardware material in most cases is stainless steel, which has strong affinity for bio-materials, including protein, peptides. This affinity leads to undesired adsorption that results in bad peak shape, low sensitivity, and inaccurate analysis.

What Material Is Biocompatible?

PEEK polymer and inert metals, such as titanium alloy, are known to be biocompatible.

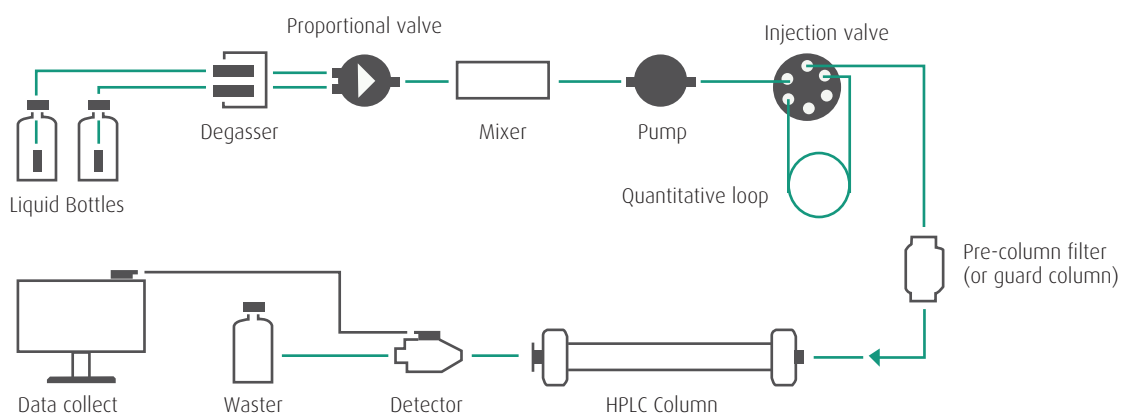

The materials of all the parts which contact to liquid and samples should be biocompatible!

Welch Materials is proud to introduce the new PEEK-lined Stainless Steel UHPLC Column for biocompatible applications. This column combines the strength of stainless steel UHPLC column with the chemical inertness of PEEK polymer to ensure bio-sample integrity by minimizing undesired surface interactions while still allowing operations under harsh solvent or pH conditions.

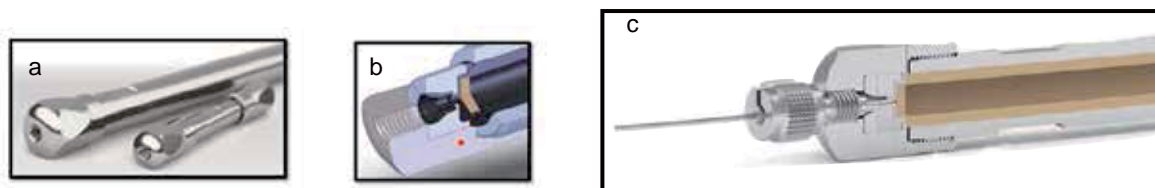

Exterior structure and interior structure(b,c) of Welch Ultisil™ Bio-UHPLC(a)

Ultisil™ Bio-UHPLC Application Scope

- Bio-separation
- Ion analysis
- Low pH
- Strong solvent

Features

PEEK-lined
Stainless Steel
Column Hardware

Packing Pressure
Rating: 20,000 psi

Operation Pressure
Rating: 150,000 psi

Maximum
Temperature: 80°C

Bonding Phases	Pore Size	Surface Area	pH Range	Endcapped
Ultisil™ Bio-UHPLC C4	300 Å	100 m ² /g	2.0-9.0	Yes
Ultisil™ Bio-UHPLC C18	300 Å	100 m ² /g	2.0-9.0	Yes
Ultisil™ Bio-UHPLC SEC*	300 Å	100 m ² /g	2.0-9.0	No

SEC(Size Exclusion Chromatography) packing materials consist of high-purity and stable silica particles bonding hydrophilic polymers.

Dimension (mm)	Particle Size (µm)	Ultisil™ Bio-UHPLCC4	Ultisil™ Bio-UHPLC C18	Ultisil™ Bio-UHPLC SEC
4.6×100	1.8	00216-13639	00201-13639	00237-13639
2.1×100	1.8	00216-13612	00201-13612	00237-13612
2.1×50	1.8	00216-13610	00201-13610	00237-13610

Chromatographic Conditions:

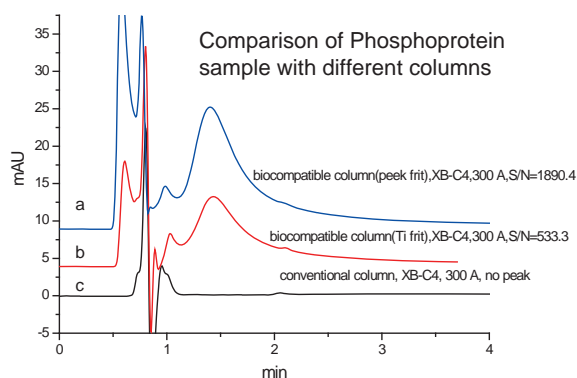

Flow Rate:	0.2 ml/min
Detector:	220 nm
Temperature:	30 °C
Injection Volume:	4.0 µl
Mobile Phase:	water/acetonitrile/TFA=90/10/0.1
Solution Preparation:	dissolve accurately weighed quantities of Phosphoproteins in mobile phase to obtain a solution having concentrations of about 5 mg of each per ml.

Fig. 1. The chromatogram of Phosphoproteins determined by three kinds of XB-C4 column (2.1×50 mm, 1.8 µm, 300 Å) a. biocompatible column(peek frit); b. biocompatible column(Ti frit); c. conventional column. The concentration of Phosphoproteins was 5 mg/ml.

According to the results shown in Fig. 1c, it can be seen that Phosphoproteins failed to elute when using conventional stainless steel columns. Fig. 1a and 1b showed that under the same concentration condition, the general trend is that the signal to noise ratio (S/N) obtained with biocompatible column using peek frit is higher than the biocompatible column using Ti frit.

Boltimate™ Core-Shell HPLC Column

Welch Boltimate™ core-shell HPLC column particle has a size of 2.7 μm , and consists of 1.7 μm solid core and 0.5 μm porous layer (porous shell).

This type of column can provide sub-2 μm efficiencies ($\sim 200,000$ p/m) and high resolution at much lower back pressure. Boltimate core-shell column can be used on both HPLC and UHPLC systems, with straight-forward method optimization process.

Features

- Sub-2 μm efficiencies ($\sim 200,000$ p/m) and ultra-high resolution at much lower back pressure
- Ultra-fast separation
- Compatible with both HPLC and UHPLC systems
- Narrow particle distribution
- A standard 2 μm inlet frit prevents plugging by dirty samples, suitable for complex sample analysis
- A variety of bonding phases provide choices of different selectivities, while always maintaining excellent peak shape and lot-to-lot reproducibility
- Maximum pressure: 600 bar

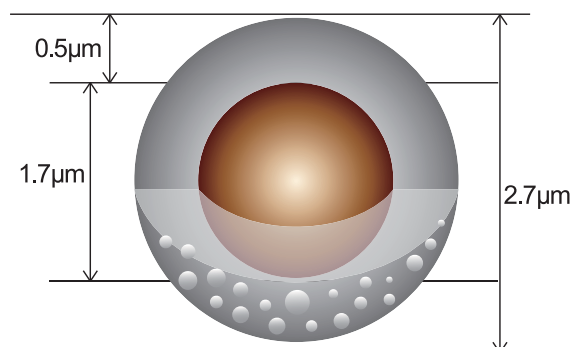

With solid core and thin porous surface layer, core-shell particles decrease the diffusion distance of sample molecules, enabling faster mobile phase flow rate leading to increased analytical speed. Compared with traditional porous HPLC columns, Boltimate core-shell column has narrower particle size distribution, resulting in higher column efficiency, higher resolution and lower back pressure.

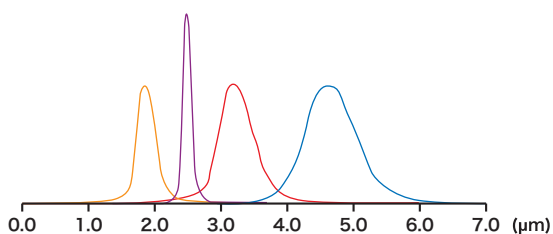

■ 1.8 μm porous silica ■ 2.7 μm core-shell silica ■ 3 μm porous silica ■ 5 μm porous silica

	D10	D90	D90/D10
5 μm porous silica	3.61	5.22	1.44
3 μm porous silica	2.83	3.98	1.41
1.8 μm porous silica	1.51	2.11	1.40
2.7 μm Boltimate core-shell silica	2.51	2.81	1.12

Theoretical Plate Number and Column Pressure (based on Naphthalene)

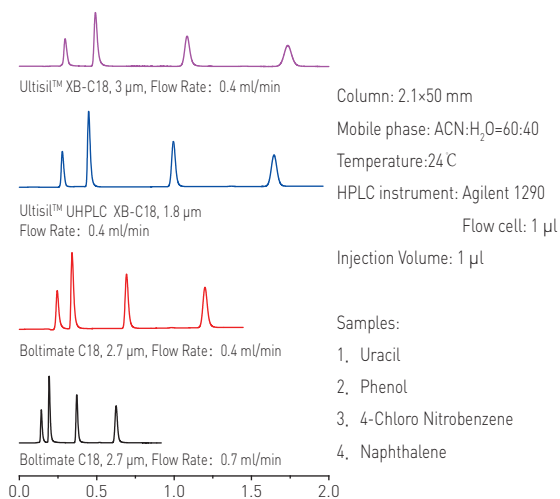

Boltimate C18 column efficiency is almost the same as that of 1.8 μm porous C18 column, and two times that of 3 μm porous C18 column.

Even with 2X faster flow rate, the pressure of Boltimate is still lower than that of 1.8 μm porous C18 column of the same dimensions under the same analysis conditions, without sacrificing efficiency at the same time.

Column	Theoretical Plates	Column Pressure (bar)	Time
Ultisil™ XB-C18, 3 μm, 2.1×50 mm	5600	85	2.0 min
Ultisil™ UHPLC XB-C18, 1.8 μm, 2.1×50 mm	10500	260	1.8 min
Boltimate™ C18, 2.7 μm, 2.1×50 mm	10100	108	1.5 min
Boltimate™ C18, 2.7 μm, 2.1×50 mm	9500	190	0.8 min

Detection of Ginsenosides:

Chromatographic conditions:

Column: three types of C18 columns from Welch / Temperature: room temperature / Detection: UV 203 nm
 Mobile phase A: 0.1% H₃PO₄ in water / Mobile phase B: Acetonitrile

1. Welch Ultisil™ XB-C18 (4.6×250 mm, 5 μm)

Flow Rate: 1.3 mL/min Injection Volume: 10 μL

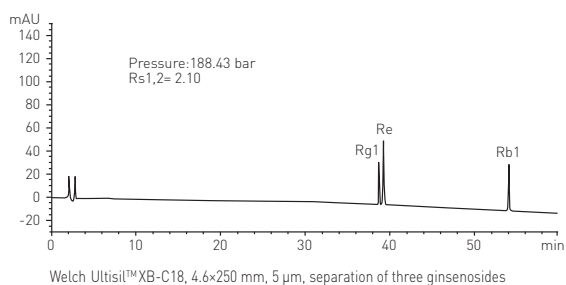

Gradient program:

Time(min)	Mobile Phase A (%)	Mobile Phase B (%)
0	81	19
30	81	19
35	76	24
60	60	40
60.1	0	100
70	0	100
70.1	81	19
78	81	19

2. Welch Ultisil™ UHPLC XB-C18 (2.1×50 mm, 1.8 μm)

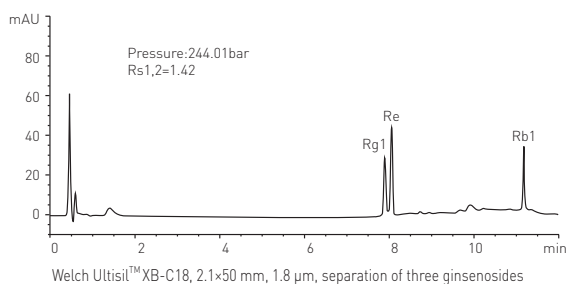

Time(min)	Mobile Phase A (%)	Mobile Phase B (%)
0	81	19
6	81	19
7	76	24
12	60	40
12.1	0	100
14	0	100
15	81	19
18	81	19

3. Welch Boltimate™ C18 (3.0×50 mm, 2.7 μm)

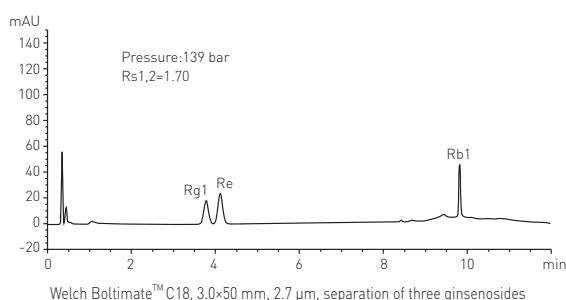

Time(min)	Mobile Phase A (%)	Mobile Phase B (%)
0	81	19
6	81	19
7	76	24
12	60	40
12.1	0	100
14	0	100
15	81	19
18	81	19

From the results above, Boltimate core-shell column has a lower column pressure and faster analysis time, and higher resolution.

Welch provides a variety of bonding phases

Bonding Phases	Features	Particle Size μm	Solid Core Diameter μm	Porous Shell Depth μm	Pore Size \AA	Surface Area m^2/g	C %	End/capped	pH Range	Maximum Pressure bar	USP List
C18	Excellent peak shape and resolution for acids, bases, and neutrals. Exceptional resolution and lifetime.	2.7	1.7	0.5	90	120	9	Double	2-8.5		L1
Phenyl-Hexyl	Alternative selectivity for phenyl groups.	2.7	1.7	0.5	90	120	7	Double	2-8.5		L11
EXT-C18	Extended pH range due to hybrid organic/inorganic layer on silica. pH range: 1.5-12	2.7	1.7	0.5	90	120	8	Double	1.5-12	600	L1
EXT-PFP	An alternative selectivity for halogenated compounds and polar analytes. Wide pH range.	2.7	1.7	0.5	90	120	5	Double	1.5-10		L43
HILIC	With its unbonded silica, Boltimate HILIC retains and separates polar analytes.	2.7	1.7	0.5	90	120	-	-	2-8.5		L3

Ordering Information

2.7 μm , 90 \AA , Boltimate Core-shell Column					
Size(mm)	C18	Phenyl-Hexyl	EXT-C18	EXT-PFP	HILIC
2.1×30	960-04009	961-04009	962-04009	963-04009	964-04009
2.1×50	960-04010	961-04010	962-04010	963-04010	964-04010
2.1×75	960-04011	961-04011	962-04011	963-04011	964-04011
2.1×100	960-04012	961-04012	962-04012	963-04012	964-04012
2.1×150	960-04014	961-04014	962-04014	963-04014	964-04014
3.0×30	960-04018	961-04018	962-04018	963-04018	964-04018
3.0×50	960-04019	961-04019	962-04019	963-04019	964-04019
3.0×75	960-04020	961-04020	962-04020	963-04020	964-04020
3.0×100	960-04021	961-04021	962-04021	963-04021	964-04021
3.0×150	960-04023	961-04023	962-04023	963-04023	964-04023
4.6×30	960-04036	961-04036	962-04036	963-04036	964-04036
4.6×50	960-04037	961-04037	962-04037	963-04037	964-04037
4.6×75	960-04038	961-04038	962-04038	963-04038	964-04038
4.6×100	960-04039	961-04039	962-4039	963-04039	964-04039
4.6×150	960-04041	961-04041	962-04041	963-04041	964-04041
4.6×250	960-04043	961-04043	962-04043	963-04043	964-04043

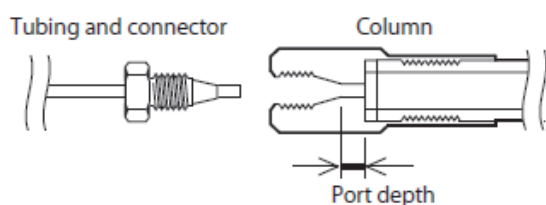

Port style of endfitting	Port depth
Parker	2 mm

An inline filter or a guard column can save your money by extending the life of your analytical column.

Inline Filter for Boltimate:

		P/N	Description
Direct connect inline filter, maximum pressure 15,000psi. Inline frit, cannot be replaced		00808-01221	Pre-column inline filter, 0.5 µm
Direct connect inline filter, maximum pressure 18,000psi.		00808-01222	Direct connect inline filter, contain 5 replaceable frits (0.2 µm)
		00808-UF020	Replaceable frits (0.2 µm)

Guard Column for Boltimate

		P/N	Description
Direct connect guard column, maximum pressure 15,000 psi, contains 5 mm cartridge		00808-01109	Direct connect guard column

Replaceable cartridge, 5 mm length Maximum pressure 15,000 psi Boltimate packing material.		Based on your HPLC column ID(mm):	
		2.0-3.0	3.2-8.0
		Choose suitable cartridge (mm):	
		2.1 × 5.0 mm	4.0 × 5.0 mm
Boltimate™ C18		U808-960-25	U808-960-45
Boltimate™ Phenyl-Hexyl		U808-961-25	U808-961-45
Boltimate™ EXT-C18		U808-962-25	U808-962-45
Boltimate™ EXT- PFP		U808-963-25	U808-963-45
Boltimate™ HILIC		U808-964-25	U808-964-45

Ultisil™ Series HPLC Column

Ultisil™ Series HPLC Columns are based on ultra-pure (purity > 99.999%) spherical and totally porous silica, unique bonding chemistry and proprietary surface modification techniques, producing excellent peak shape, column efficiency and exceptional lot-to-lot reproducibility. Ultisil™ column is the best choice for method development, owing to complete bonding chemistries and stable performance.

Features:

- Competitive price
- Ultra-pure spherical porous silica, purity > 99.999%
- Unique bonding chemistry and endcapping technology
- High efficiency: theoretical plate > 80,000/m
- Excellent peak symmetry: tailing factor=0.95~1.05
- Wide pH range: 1.5-10
- Long column lifetime
- Exceptional lot-to-lot reproducibility
- Complete bonding chemistries with different selectivities

Ultisil™ HPLC Column Packing Materials

Pictures below show size uniformity and surface smoothness of the packing particles, characteristics that enable more uniform packing with less channeling effect, resulting in lower back pressure and higher column efficiency. Our silica has a surface area of 320 m²/g with a controlled mean pore size of 120 Å.

SEM Pictures of Ultisil™ Particles

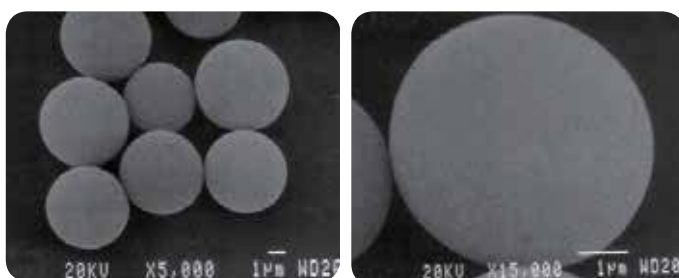

Ultisil™ Pore Size Distribution

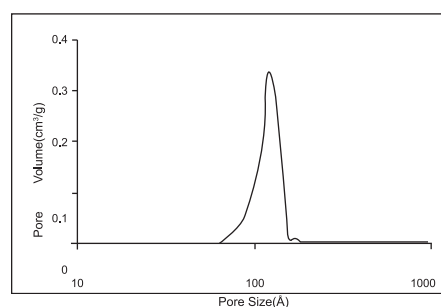

Trace Amount Metal Contents Test

A useful chromatographic test of trace amount of metal contents in the column is to compare the peak symmetry of one pair of positional isomers, 4,4'-dipyridyl and 2,2'-dipyridyl, and a neutral chelating reagent, 1,2-dihydroxynaphthalene. 4,4'-dipyridyl, which cannot form chelating complex with metal, is used as a reference. 2,2'-dipyridyl and 1,2-dihydroxynaphthalene, which are chelating reagents, are sensitive to trace amount metal in silica. When a C18 column based on type A silica or other so-called type B silica with higher metal content is used, the peaks of 2,2'-dipyridyl and 1,2-dihydroxynaphthalene would tail or even totally disappear.

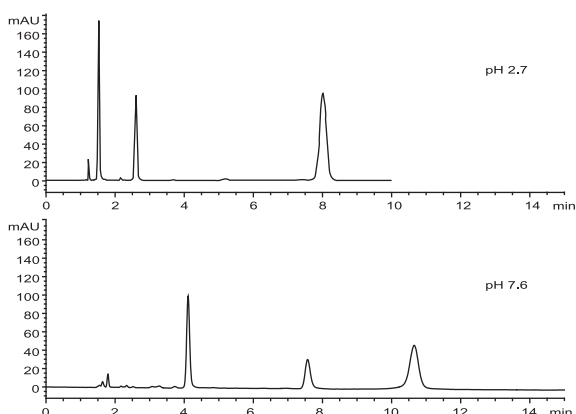

Column:	Ultisil™ XB-C18, 4.6 × 150 mm, 5 µm
Mobile Phase:	45% MeOH/55% 20 mM phosphate, pH 7.6
Flow Rate:	1.0 ml/min
Detector:	215 nm
Temperature:	25 °C
Injection Volume:	1 µl
Samples:	1) 4,4'-Dipyridyl 2) 2,2'-Dipyridyl 3) 1,2-Dihydroxynaphthalene

Ultisil™ XB Series HPLC Column

Ultisil™ XB series column is the first series introduced by Welch. This series spans complete bonding chemistries, and provides a variety of selectivities for method development.

- Easy to develop or improve your HPLC method
- Excellent performance, exceptionally rugged USP phases
- Exceptional lot-to-lot reproducibility

Ultisil™ XB-C18—Universal HPLC Analytical Column

Ultisil™ XB-C18 is the most commonly used column in the market. It can substitute Waters Symmetry C18, Agilent Zorbax XDB C18, Phenomenex Luna C18, Supelcosil LC-18-DB, YMC ODS-AM, Alltima C18, GL, Inertsil ODS-2 etc. XB-C18 has high theoretical plates and peak capacity, so it's suitable for analysis of complex samples.

Separation of Basic Compound Antidepressant at pH 7.0

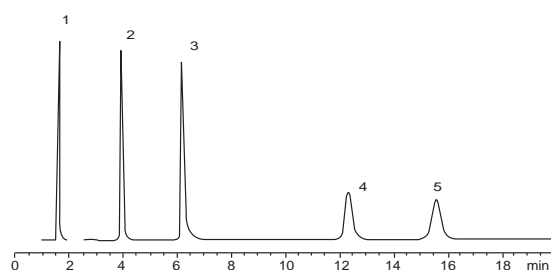

Column:	Ultisil™ XB-C18, 4.6 × 150 mm, 5 μm	
Mobile Phase:	20% phosphate, pH 7.0. 80% MeOH	
Flow Rate:	1.0 mL/min	
Detector:	215 nm	
Temperature:	25 °C	
Samples:	1) Uracil	2) Ropranolol
	3) Ortriptyline	4) Amitriptyline
	5) Trimipramine	

Comparison of Peak Shape Between Batch to Batch

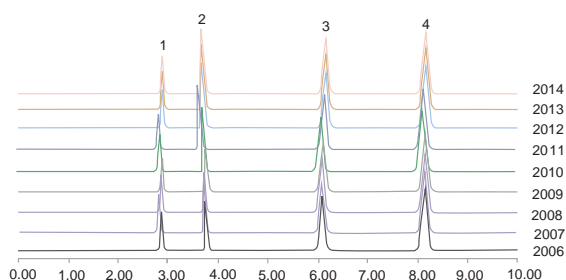

Column:	Ultisil™ XB-C18, 4.6 × 250 mm, 5 μm	
Mobile Phase:	75% MeOH/25% water	
Flow Rate:	1.0 mL/min	
Detector:	254 nm	
Temperature :	25 °C	
Samples:	1) Uracil	2) Phenol
	3) 4-chloronitrobenzene	4) Methylbenzene

Capacity Factor(K') of Batch to Batch Reproducibility

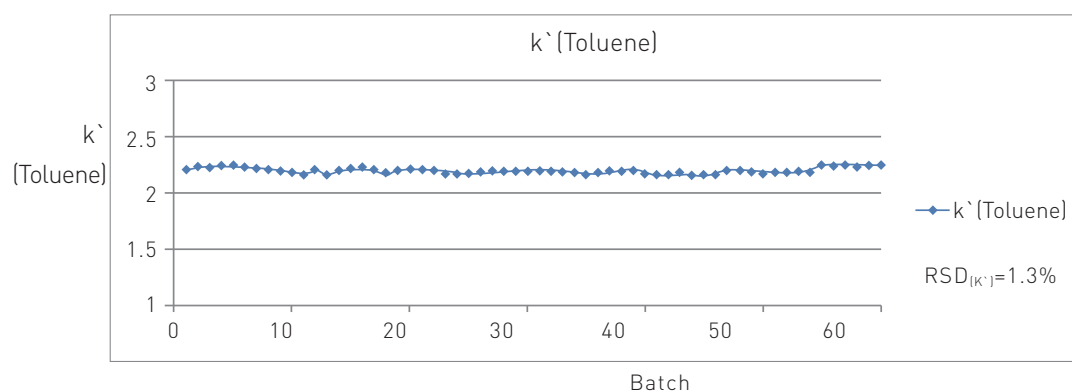

Analysis of Prednisone Acetate

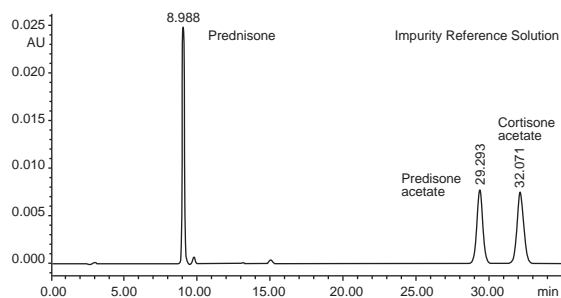

Column:	Ultisil™ XB-C18, 4.6 ×150 mm, 5 μm
Mobile Phase:	ACN/Water=33:67
Flow Rate:	1.0 ml/min
Detector:	240 nm
Temperature:	30 °C
Injection Volume:	20 μl

Analysis of Aflatoxin

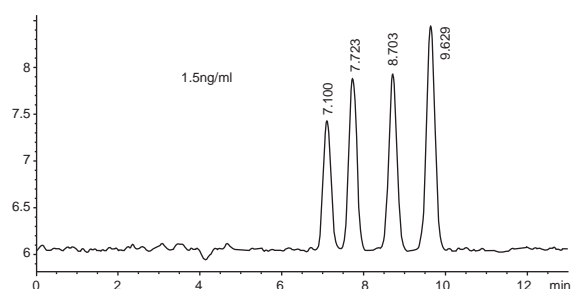

Column:	Ultisil™ XB-C18, 4.6×250 mm, 5 μm
Mobile Phase:	Water:MeOH:ACN=46:40:14
Flow Rate:	1.0 ml/min
Detector:	Excitation wavelength:360 nm Emission wavelength:450 nm Gain:17
Temperature:	30 °C
Derivation Way:	Post-column photo chemical derivation [254 nm]

Aflatoxin B1, B2, G1, G2 mixed standards, meets separation requirements

Tropa Belladonna Spectrogram

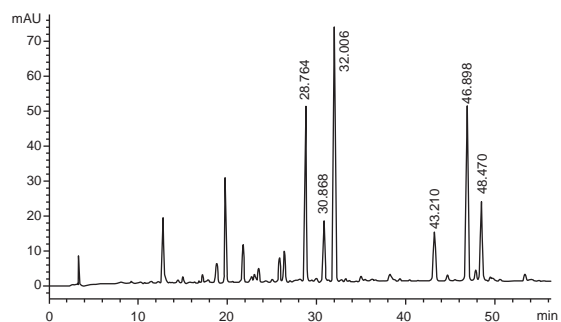

Column:	Ultisil™ Special column for Tropa Belladonan, 4.6 ×250 mm, 5 μm
Mobile Phase:	Mobile phase A: MeOH Mobile phase B:0.05% Phosphoric acid solution
Flow Rate:	1.0 ml/min
Detector:	344 nm
Temperature:	30 °C
Injection Volume:	10 μl

Analysis of Donkey-hide Gelatin

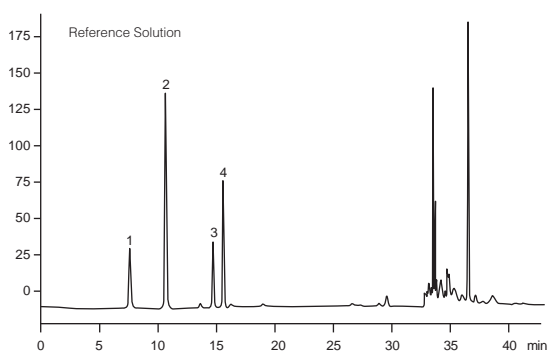

Column:	Ultisil™ XB-C18, 4.6 ×250 mm, 5 μm
Mobile Phase:	Mobile phase A: ACN:0.1 mol/l NaAC(pH 6.5)=7:93 Mobile phase B: ACN:water=4:1
Gradient Program:	Time(min) Mobile Phase A Mobile Phase B
	0~11 100~93 0~7
	11~13.9 93~88 7~12
	13.9~14 88~85 12~15
	14~29 85~66 15~34
	29~30 66~0 34~100
Flow Rate:	1.0 ml/min
Temperature:	43 °C
Injection Volume:	5 μl
Reference Samples:	L-hydroxyproline, glycine, alanine, L-proline

Excellent Stability at Low pH and High pH

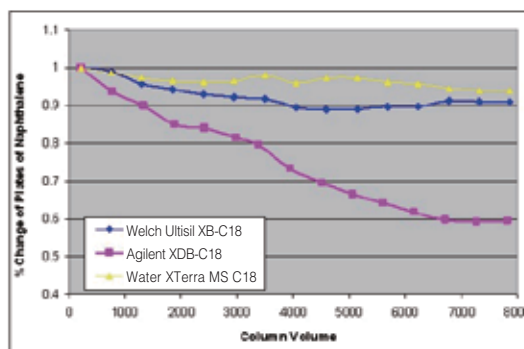
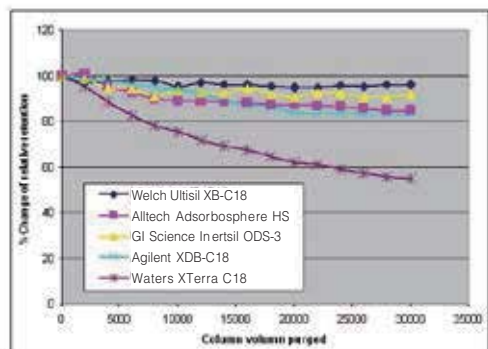

The stability of XB-C18 is better than other brand columns under pH 1.3 or under pH 10.

Ultisil™ XB-C8----Less retentive than XB-C18

The XB-C8 phase is less retentive than XB-C18 phase, useful for strong hydrophobic compounds that are too strongly retained on C18 phase, and for LC/MS applications, where long retention is not desired. When separating neutral or other highly retained compounds, XB-C8 can save analytical time. However, when separating polar compounds, XB-C8 column provides different selectivity than does XB-C18 column.

Comparison of Retention of XB-C18 and XB-C8

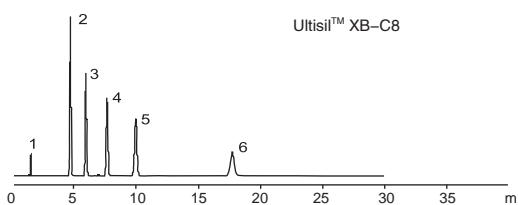
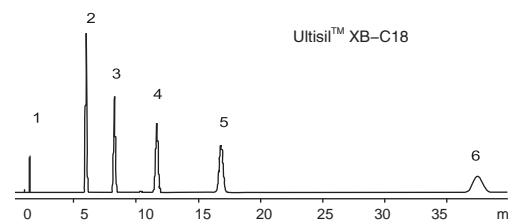

Column:	4.6 ×150 mm, 5 μm
Mobile Phase:	30% water/70% ACN
Flow Rate:	1.0 ml/min
Detector:	344 nm
Temperature:	25 °C
Samples:	1. Uracil 2. Ethylbenzene 3. Propylbenzene 4. Butylbenzene 5. Amylbenzene 6. Heptylbenzene

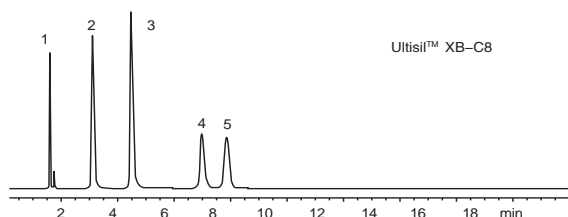
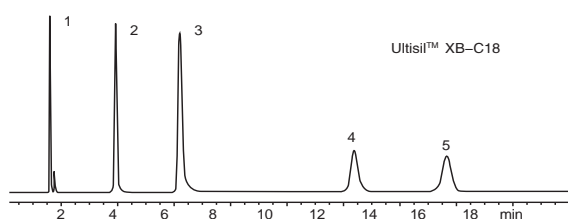

Column:	4.6 ×150 mm, 5 μm
Mobile Phase:	20% 20 mM phosphate, pH 7.0, 80% MeOH
Flow Rate:	1.0 ml/min
Detector:	215 nm
Temperature:	25 °C
Samples:	1. Uracil 2. Ropranolol 3. Ortriptyline 4. Amitriptyline 5. Trimipramine

Analysis of Adefovir Dipivoxil

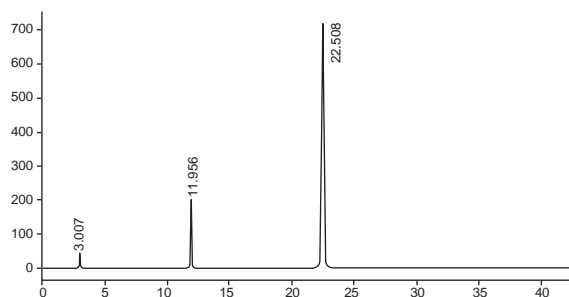

Column:	Ultisil™ XB-C8, 4.6×250 mm, 5 μm		
Mobile Phase:	Mobile phase A: 0.05 mol/l KH ₂ PO ₄ buffer: ACN=50:50 Mobile phase B: 0.05 mol/l KH ₂ PO ₄		
Gradient Program:	Time(min)	Mobile Phase A	Mobile Phase B
	0	20	80
	5	20	80
	20	100	0
	32	100	0
	40	20	80
Flow Rate:	1.0 ml/min		
Temperature:	40 °C		
Injection Volume:	10 μl		
System suitability solution: Adefovir, Adefovir Monopivoxil, Adefovir Dipivoxil.			

Analysis of Albuterol

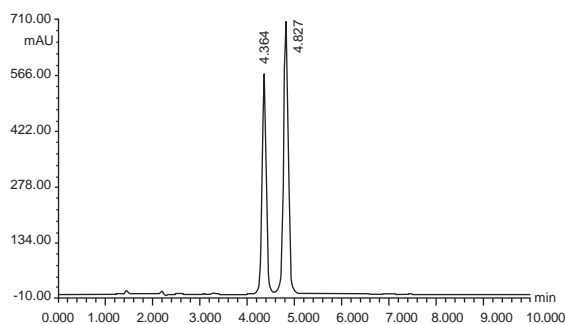

Column:	Ultisil™ XB-C8, 4.6×150 mm, 5 μm		
Mobile Phase:	Sodium heptanesulfonate solution(Sodium heptanesulfonate 2.5 g, dilute with water to 1000ml, adjust pH to 3.65 with H ₃ PO ₄):ACN=78:22		
Flow Rate:	1.0 ml/min		
Detector:	220 nm		
Temperature:	30 °C		
Injection Volume:	20 μl		

Analysis of Insulin Detemir

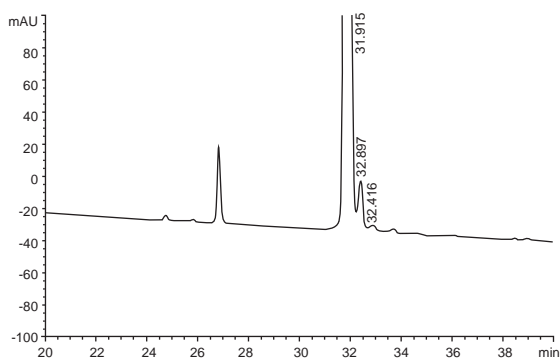

Column:	Ultisil™ XB-C8, 4.6×150 mm, 5 μm		
Mobile Phase:	A: 20 g (NH ₄) ₂ SO ₄ , 900 ml water, 100 ml ACN, adjust pH to 2.3 B: ACN:water=80:20; %B=0(0 min) , 30(9 min), 60(40 min)		
Flow Rate:	1.0 ml/min		
Detector:	214 nm		
Temperature:	30 °C		
Injection Volume:	20 μl		

Ultisil™ XB-Phenyl--- Different selectivity to alkyl phase

Ultisil™ XB-Phenyl phase is less retentive than conventional C18 or C8 phases, but more retentive than standard cyano phase. Due to their ability to participate in π - π interactions, XB-Phenyl columns may actually be more retentive than C18 or C8 columns towards certain polar aromatic compounds, depending on running conditions. The selectivity for highly polar aromatics, which is poorly retained on alkyl-bonded phases, together with reduced retentivity towards non-polar compounds, makes XB-Phenyl an excellent choice for the analysis of complex mixtures of polar and non-polar analytes. Additionally, this bonding phase boasts high surface coverage and exhaustive double end-capping, leading to better performance.

Unique Selectivity for Aromatic Compounds of Ultisil™ XB-Phenyl Phase

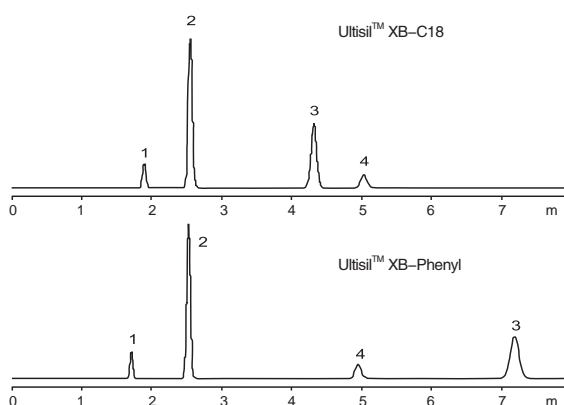

Column:	4.6×150 mm, 5 μ m
Mobile Phase:	70% MeOH/30% water
Flow Rate:	1.0 ml/min
Detector:	254 nm
Temperature:	24 °C
Samples:	1. Uracil 2. Phenol 3. Paranitrotoluene 4. Toluene

Analysis of Galuteolin in Honeysuckle

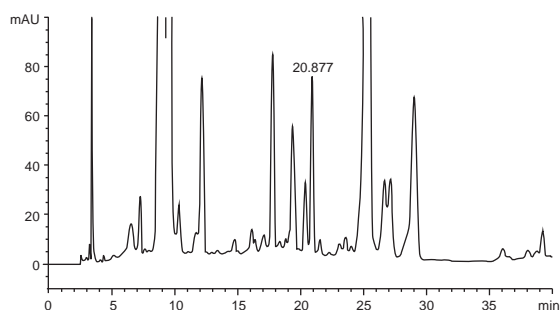

Column:	Ultisil™ XB-Phenyl, 4.6×250 mm, 5 μ m
Mobile Phase:	A:ACN B:0.5% glacial acetic acid
Gradient Program:	Time(min) A(%) B(%)
	0-15 10-20 90-80
	15-30 20 80
	30-40 30 80-70
Flow Rate:	1.0 ml/min
Detector:	350 nm
Temperature:	30 °C
Injection Volume:	10 μ l

Analysis of Galuteolin in Honeysuckle

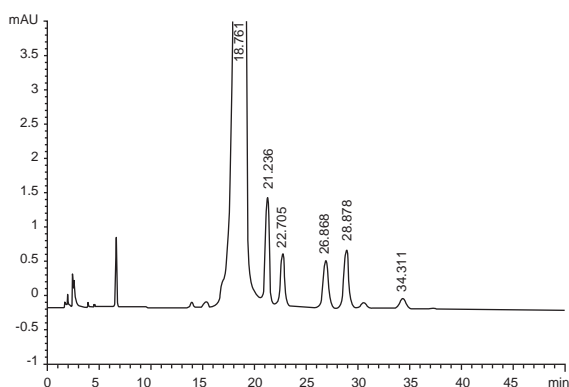

Column:	Ultisil™ XB-Phenyl, 4.6×250 mm, 5 μ m
Mobile Phase:	(0.5 g TBAHS, 1 g KH ₂ PO ₄ , 3.4 g [2 ml] H ₃ PO ₄ , 1000 ml water):MeOH=72:28
Flow Rate:	1.3 ml/min
Detector:	293 nm
Temperature:	45 °C
Injection Volume:	10 μ l

Separation of Montelukast Sodium Isomers

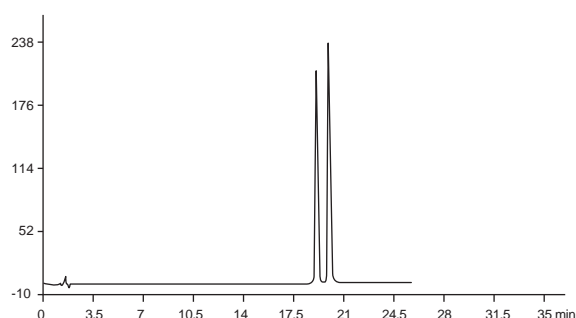

Column:	Ultisil™ XB-Phenyl, 4.6×150 mm, 3 μm		
Mobile Phase:	A: 0.2% TFA B: MeOH:ACN=60:40		
	Time(min)	A(%)	B(%)
	0	48	52
	5	45	55
	12	45	55
	22	25	75
	23	25	75
	25	48	52
	30	48	52
Flow Rate:	1.0 ml/min		
Detector:	255 nm		
Temperature:	30 °C		
Injection Volume:	10 μl		

Ultisil™ XB-C4---Suitable for separation of bio-samples

- Strong retention for hydrophobic and polar compounds
- Column packing of 300 Å big pore size particles is appropriate for separation of peptide and protein samples with sharp peak shape
- Minibore column can be used for LC/MS/MS

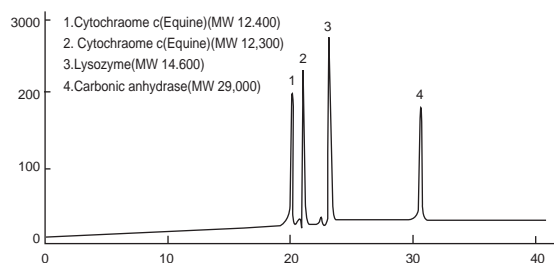

Column:	Ultisil™ XB-C4(300 Å), 4.6×250 mm, 5 μm
Mobile Phase:	A: H ₂ O:ACN:TFA=90:10:0.05 B: H ₂ O:ACN:TFA=20:80:0.05 0%-100%B(0-15 min)
Flow Rate:	1.0 ml/min
Temperature:	45 °C
Injection Volume:	10 μl

Ultisil™ XB-CN---Unique selectivity for polar compounds

Ultisil™ XB-CN column can be used in either reversed or normal phase. Reversed phase CN column has special selectivity for polar compounds, and due to its low hydrophobicity, elution of hydrophobic molecules is fast. Furthermore, XB-CN column shows perfect peak shape for strong basic analytes (including quaternary ammonium salts). Polarity of XB-CN column is the strongest among all reversed columns. It is a good choice for compounds that are strongly retained on standard reversed columns.

Normal phase CN column can replace SiO₂ column. Equilibrium of normal phase column is fast, and the silica surface activity is better than that of silica column. To prolong column life time, alternation between reversed phase and normal phase uses should be avoided. While XB-CN column can be used in either reversed or normal phase, elution sequence is different in different separation mode.

- Can be used in either reversed or normal phases
- Stable bonding chemistry and excellent surface coverage
- Low hydrophobicity, unique selectivity

Analysis of Alogliptin Benzoate

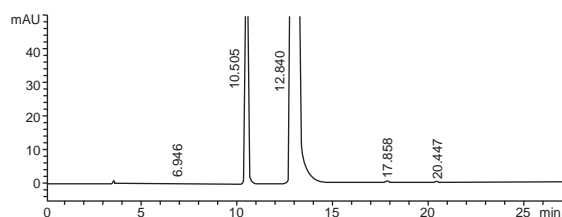

Column:	Ultisil™ XB-CN, 4.6×250 mm, 5 μm		
Mobile Phase:	A: ACN/water/TFA=100/1900/1 B: ACN/water/TFA=1900:100:1		
	Time[min]	A(%)	B(%)
	0	99	1
	30	80	20
	50	10	90
	51	99	1
Flow Rate:	1.0 ml/min		
Detector:	278 nm		
Temperature:	35 °C		
Injection Volume:	20 μl		

Analysis of Rifampicin Isoniazidand Pyrazinamide

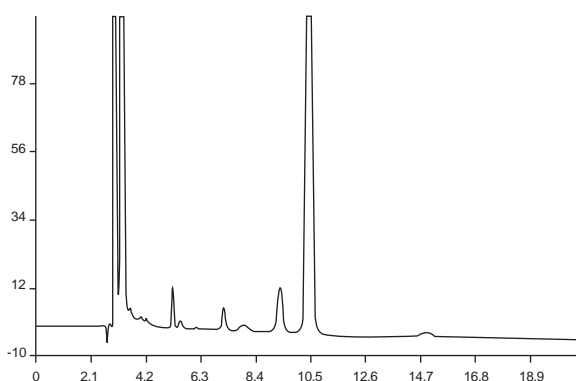

Column:	Ultisil™ XB-CN, 4.6×250 mm, 5 μm		
Mobile Phase:	0.01 mol/l Sodium Heptanesulfonate (Sodium Heptanesulfonate 2.0225 g, 1000 ml water, adjust pH to 1.85 with H ₃ PO ₄):ACN=54:46		
Flow Rate:	0.6 ml/min		
Detector:	254 nm		
Temperature:	30 °C		
Injection Volume:	20 μl		

Ultisil™ XB Series Normal Phase Column

Ultisil™ XB series normal phase columns consist of XB-NH₂, XB-CN, SiO₂ and Diol columns.

Ultisil™ SiO₂ Column

Ultisil™ SiO₂ column uses ultra-high purity type B silica particles with no metal contents. SiO₂ column can separate strong hydrophilic compounds in high concentration organic solvent in normal phase. Good result can be obtained for the analysis of polar compounds which are prone to peak tailing in reversed phase.

Analysis of VD₂

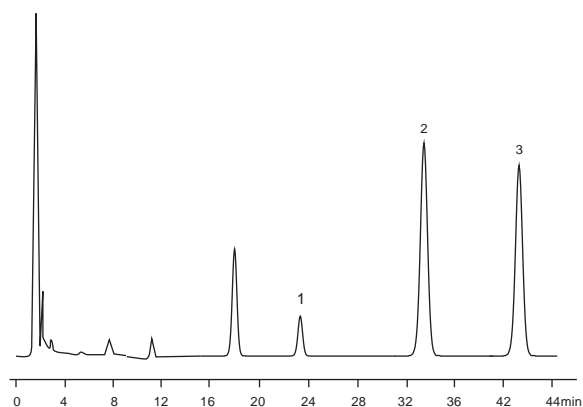

Column:	Ultisil™ SiO ₂ , 4.6×250 mm, 5 μm		
Mobile Phase:	Hexane/ IPA = 997/ 3		
Flow Rate:	2.0 ml/min		
Detector:	254 nm		
Temperature:	30 °C		
Samples:	1. Facade VD ₂ 2. Internal Standard 3. VD ₂		

Analysis of VD₃

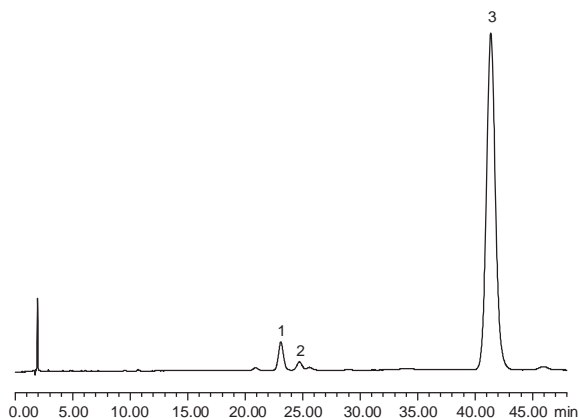

Column:	Ultisil™ SiO ₂ , 4.6 ×250 mm, 5 μm
Mobile Phase:	N-hexane:n-amy alcohol=99.7:0.3
Detector:	254 nm
Temperature:	30 °C
Flow Rate:	2.0 ml/min
Samples:	1. Facade VD ₃ 2. Trans VD3 3. VD ₂

Analysis of VA Acetate

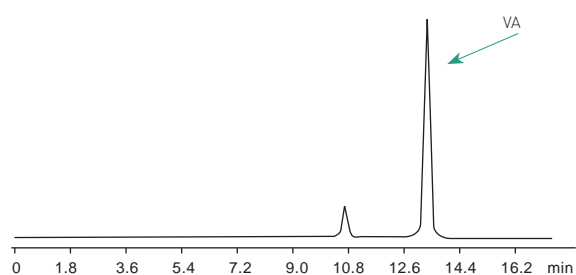

Column:	Ultisil™ SiO ₂ , 4.6 ×250 mm, 5 μm
Mobile Phase:	N-hexane:isopropanol=99.8:0.2
Detector:	326 nm
Temperature:	16 °C
Flow Rate:	1.0 ml/min
Sample is dissolved with n-hexane.	

Analysis of Pesticide Emulsifier Triton-X100

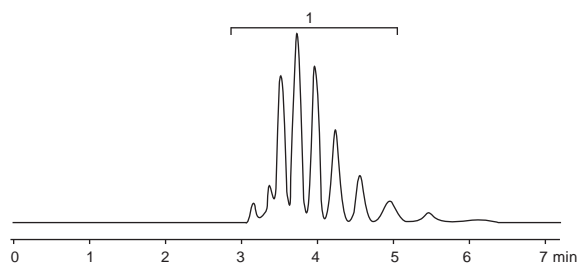

Column:	Ultisil™ SiO ₂ , 4.6 ×250 mm, 5 μm
Mobile Phase:	Ethyl Acetate:EtOH=80:20
Detector:	254 nm
Temperature:	30 °C
Flow Rate:	1.0 ml/min



Ultisil™ XB-NH₂ Column

Ultisil™ XB-NH₂ column is based on propyl-amino silane, mostly used in normal phase, but can also be used in HILIC mode and reversed phase.

- Used in normal phase for weak anion-exchange, and in reversed-phase HPLC for polar compounds
- For applications in aggressive normal phase mode with aqueous eluent
- Vitamins A and D can be separated in the normal-phase mode
- Carbohydrates and sugars can be separated in the reversed-phase mode

Acarbose

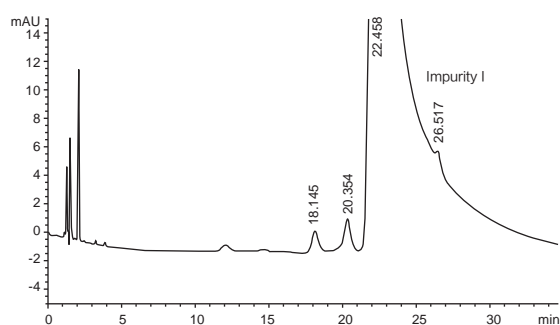

Column:	Ultisil™ XB-NH ₂ , 4.6 ×250 mm, 5 μm
Mobile Phase:	Phosphate buffer(KH ₂ PO ₄ 600 mg, ADSP 279 mg, dissolve in 100 ml water and dilute to 1000 ml): ACN=28:72
Detector:	210 nm
Temperature:	35 °C
Flow Rate:	2.0 ml/min
Injection Volume:	10 μl

Sugars

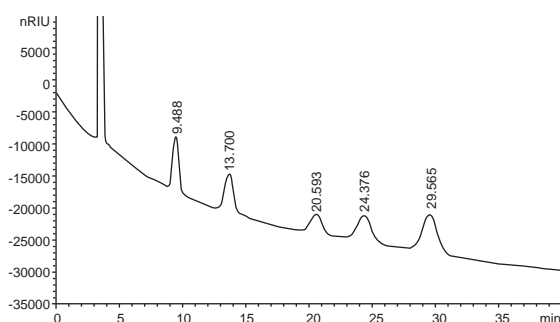

Column:	Ultisil™ XB-NH ₂ , 4.6 ×250 mm, 5 μm
Mobile Phase:	70% ACN-water solution
Detector:	RID
Temperature:	35 °C
Flow Rate:	0.9 ml/min
Injection Volume:	10 μl
Samples:	Fructose, glucose, maltose, maltotriose, maltopentaose in order

Acetyl-L-carnitine

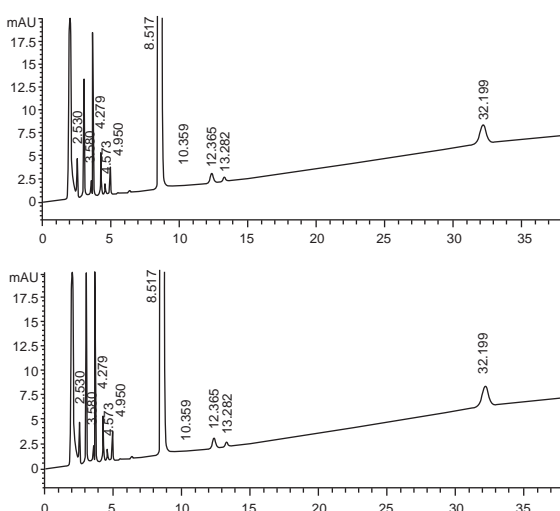

Column:	Ultisil™ XB-NH ₂ , 4.6 ×250 mm, 5 μm
Mobile Phase:	Buffer:ACN=30:70
Detector:	205 nm 210 nm
Temperature:	20 °C
Flow Rate:	1.0 ml/min
Injection Volume:	10 μl

Ordering Information

3 μm Minibore Column

	XB-C18	XB-C8	XB-C4	XB-C1	XB-Phenyl	XB-CN	XB-NH₂	SiO₂
2.1×30	00201-21009	00202-21009	00216-21009	00217-21009	00203-21009	00205-21009	00204-21009	00200-21009
2.1×50	00201-21010	00202-21010	00216-21010	00217-21010	00203-21010	00205-21010	00204-21010	00200-21010
2.1×100	00201-21012	00202-21012	00216-21012	00217-21012	00203-21012	00205-21012	00204-21012	00200-21012
2.1×150	00201-21041	00202-21041	00216-21041	00217-21041	00203-21041	00205-21041	00204-21041	00200-21041

5 μm Minibore Column

	XB-C18	XB-C8	XB-C4	XB-C1	XB-Phenyl	XB-CN	XB-NH₂	SiO₂
2.1×30	00201-31009	00202-31009	00216-31009	00217-31009	00203-31009	00205-31009	00204-31009	00200-31009
2.1×50	00201-31010	00202-31010	00216-31010	00217-31010	00203-31010	00205-31010	00204-31010	00200-31010
2.1×100	00201-31012	00202-31012	00216-31012	00217-31012	00203-31012	00205-31012	00204-31012	00200-31012
2.1×150	00201-31041	00202-31041	00216-31041	00217-31041	00203-31041	00205-31041	00204-31041	00200-31041

3 μm Analytical Column

	XB-C18	XB-C8	XB-C4	XB-C1	XB-Phenyl	XB-CN	XB-NH₂	SiO₂
3.0×30	00201-21018	00202-21018	00216-21018	00217-21018	00203-21018	00205-21018	00204-21018	00200-21018
3.0×50	00201-21019	00202-21019	00216-21019	00217-21019	00203-21019	00205-21019	00204-21019	00200-21019
4.6×50	00201-21037	00202-21037	00216-21037	00217-21037	00203-21037	00205-21037	00204-21037	00200-21037
4.6×150	00201-21041	00202-21041	00216-21041	00217-21041	00203-21041	00205-21041	00204-21041	00200-21041

5 μm Analytical Column

	XB-C18	XB-C8	XB-C4	XB-C1	XB-Phenyl	XB-CN	XB-NH₂	SiO₂
4.6×50	00201-31037	00202-31037	00216-31037	00217-31037	00203-31037	00205-31037	00204-31037	00200-31037
4.6×100	00201-31039	00202-31039	00216-31039	00217-31039	00203-31039	00205-31039	00204-31039	00200-31039
4.6×150	00201-31041	00202-31041	00216-31041	00217-31041	00203-31041	00205-31041	00204-31041	00200-31041
4.6×250	00201-31043	00202-31043	00216-31043	00217-31043	00203-31043	00205-31043	00204-31043	00200-31043

Welch provides 120 Å and 300 Å pore size packing materials. Please contact Welch or your local distributor for other dimensions.

Ultisil™ Diol Column

Ultisil™ Diol Column is based on ultra-pure porous spherical silica bonded with 1,2-dihydroxypropyl functional group silica. Ultisil™ Diol is used in normal phase mostly, but can also be used in HILIC mode, suitable for separation of peptides, proteins, polar molecules, and organic acids and its polymers.

Like bare silica, Ultisil™ Diol has the ability to form hydrogen bonds and is capable of separating structure isomers. Since most of its surface is covered with organic functions, Ultisil™ Diol absorbs less water, which leads to more reproducible activity. It is also the sorbent of choice when working in normal phase in the presence of water. It has a different selectivity than bare silica gel, and slight modification in the composition of solvent mixture may be necessary to obtain a similar retention.

Ultisil™ Diol column is more stable than traditional normal phase columns, such as NH₂, SiO₂. Compared with NH₂/SiO₂ column, Diol column is not sensitive to water. Ultisil™ Diol column can also be used in reversed phase analysis.

- More stable than traditional normal phase columns, such as Silica, Amine
- Can be used in reversed phase analysis
- Similar polarity to Amine
- Good selectivity without excessive retention
- Improved peak shape compared to bare silica

Tacrolimus

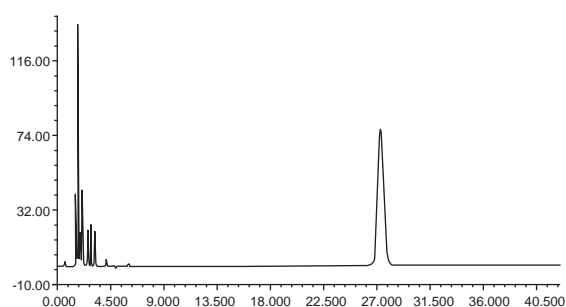

Column:	Ultisil™ Diol, 4.6 ×250 mm, 5 μm
Mobile Phase:	N-hexane:butyl chloride:ACN=7:2:1
Detector:	225 nm
Temperature:	Ambient
Flow Rate:	1.7 ml/min
Injection Volume:	5 μl

Cloprostenol Sodium α, β

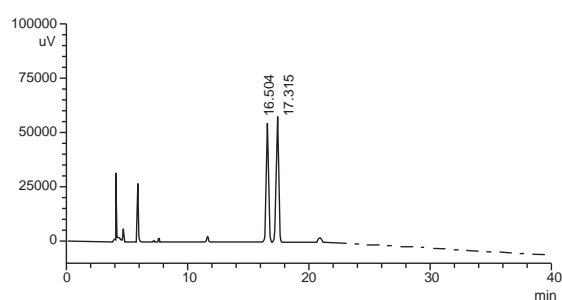

Column:	Ultisil™ Diol, 4.6 ×300 mm, 3 μm
Mobile Phase:	N-hexane/isopropanol(v/v)=99.5/0.5
Flow Rate:	1.0 ml/min
Detector:	220 nm
Temperature:	25 °C
Injection Volume:	10 μl

Ultisil™ XB-SAX and XB-SCX Ion Exchange Column

Ultisil™ ion exchange columns are available for both Strong Anion Exchange (SAX) and Strong Cation Exchange (SCX) columns. The SCX/SAX columns are silica based with high resolution and high efficiency.

Ultisil™ SAX is a polar bonded phase, consisting of an ammonium-functionalized silane, while Ultisil™ SCX is a classical strong cation exchange, consisting of a covalently bonded aromatic sulfonic acid moiety.

- Organic modifiers such as acetonitrile and methanol may be used with SAX and SCX columns, within organic/buffer solubility constraints
- Retention can be controlled by varying pH, ionic strength and organic modifier content
- Stable pH range from 2.0 to 7.0

13 Heparin Disaccharides

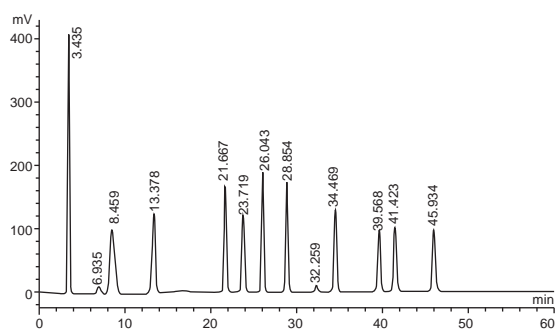

Column:	Ultisil™ XB-SAX, 3.0 ×250 mm, 5 μm
Mobile Phase:	A: weight 0.308 g NaH ₂ PO ₄ to 1000 ml volumetric flask, add 950 ml water to dissolve it, adjust pH with H ₃ PO ₄ to 2.9, then add water to scale mark. B: weight 122 g NaClO ₄ to 1000 ml volumetric flask, add 950 ml mobile phase A to dissolve, adjust pH to 3.0 with H ₃ PO ₄ , then add mobile phase A to scale mark.
Detector:	234 nm, 202 nm
Temperature:	50 °C
Flow Rate:	0.45 ml/min
Injection Volume:	10 μl

Chondroitin Sulfate

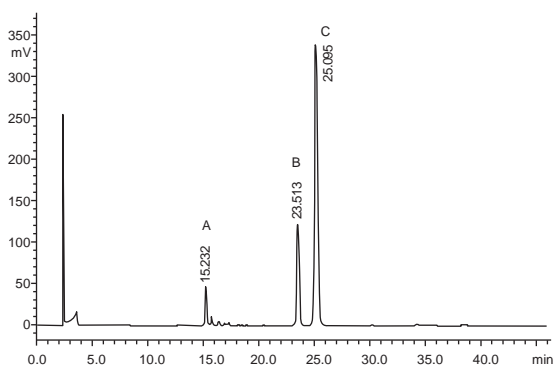

Column:	Ultisil™ XB-SAX, 4.6 ×250 mm, 5 μm
Mobile Phase:	A: water, adjust pH to 3.5 with diluted HCl B: 2 mol/l NaCl, adjust pH to 3.5 with diluted HCl
Detector:	232 nm
Temperature:	Ambient
Flow Rate:	1.0 ml/min
Injection Volume:	20 μl
Mixed Standards:	Chondroitin disaccharide(B) 6- sulfated chondroitin disaccharide(C) 4- sulfated chondroitin disaccharide(A)

Leonurus Granule

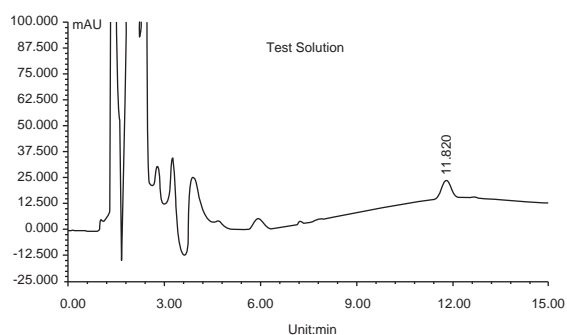

Column:	Ultisil™ XB-SCX, 4.6 ×150 mm, 5 μm
Mobile Phase:	ACN:0.05 mol/LKH ₂ PO ₄ :H ₃ PO ₄ =15:85:0.15
Detector:	192 nm
Temperature:	Ambient
Flow Rate:	1.0 ml/min
Injection Volume:	10 μl

Melamine

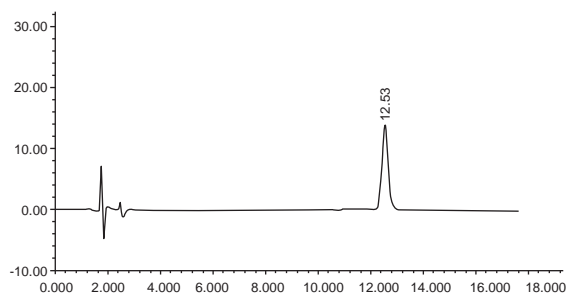

Column:	Ultisil™ XB-SCX, 4.6 ×250 mm, 5 μm
Mobile Phase:	0.05M KH ₂ PO ₄ (adjust pH to 4.7 with H ₃ PO ₄):ACN=70:30
Detector:	240 nm
Temperature:	25 °C
Flow Rate:	1.5 ml/min
Injection Volume:	20 μl

Metformin HCL

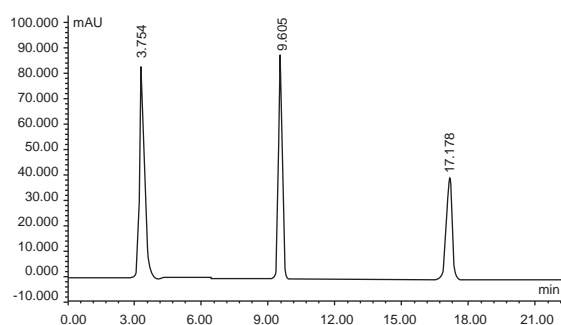

Column:	Ultisil™ XB-SCX, 4.6 ×250 mm, 5 μm
Mobile Phase:	1.7% NH ₄ H ₂ PO ₄ (adjust pH to 3.0 with H ₃ PO ₄)
Detector:	218 nm
Temperature:	Ambient
Flow Rate:	1.0 ml/min
Injection Volume:	10 μl
Samples In Order:	Icyandiamide, Melamine, Metformin HCL

Domiphen Bromide Buccal Tablets

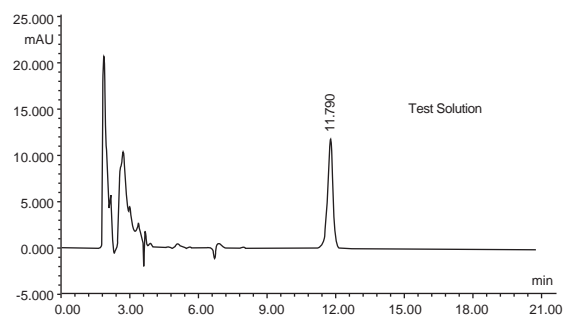

Column:	Ultisil™ XB-SCX, 4.6 ×250 mm, 5 μm
Mobile Phase:	MeOH:0.05 mol/l NaAC=80:20
Detector:	274 nm
Temperature:	Ambient
Flow Rate:	1.0 ml/min
Injection Volume:	100 μl

Ordering information

Dimensions	XB-SCX	XB-SAX	Diol
3 μm, 2.1×150 mm	00212-21014	00213-21014	00206-21014
3 μm, 4.6×150 mm	00212-21041	00213-21041	00206-21041
3 μm, 4.6×250 mm	00212-21043	00213-21043	00206-21043
3 μm, 4.6×300 mm	00212-21044	00213-21044	00206-21044
3 μm, 7.8×300 mm	00212-21052	00213-21052	00206-21052
5 μm, 2.1×150 mm	00212-31014	00213-31014	00206-31014
5 μm, 4.6×150 mm	00212-31041	00213-31041	00206-31041
5 μm, 4.6×250 mm	00212-31043	00213-31043	00206-31043
5 μm, 4.6×300 mm	00212-31044	00213-31044	00206-31044
5 μm, 7.8×300 mm	00212-31052	00213-31052	00206-31052

Welch provides 120 Å, 300 Å pore size packing materials. Please contact Welch or your local distributor for other dimensions.

Ultisil™ AQ-C18----The most widely used column in food industry

Ultisil™ AQ-C18 columns are designed to have extended retention and selectivity for hydrophilic and polar compounds, which are poorly or not at all retained on other phases. A proprietary bonding chemistry, Ultisil™ AQ-C18 avoids so-called "phase collapse", even when 100% water is used, a phenomenon that conventional C18 columns typically exhibit at high water content in the mobile phase. Ultisil™ AQ-C18 phase is fully end-capped to ensure the best peak shapes of polar and basic compounds and longer lifetime. Typical applications are separations of water soluble compounds that cannot be retained on traditional C18 phase. Examples include biomolecules, metabolites, and pharmaceutical degradants such as organic acids, water-soluble vitamins, oligosaccharides, amino acids, and small peptides and nucleotides.

Features:

- No phase collapse, suitable for high aqueous mobile phase
- Less retentive than XB-C18 for non-polar compounds
- Increased retention for polar and water soluble compounds
- Carbon loading: 12%, pore size: 120 Å, particle size: 3 µm, 5 µm, 10 µm

Phase Collapse Research

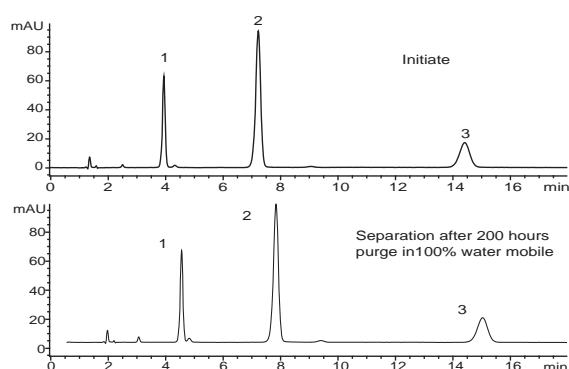

Column:	Ultisil™ AQ-C18, 4.6 ×100 mm, 5 µm
Mobile Phase:	10% ACN/90% 50 mM phosphate, pH 3.5
Detector:	215 nm
Temperature:	25 °C
Flow Rate:	1.0 ml/min
Samples:	1. Theophylline 2. Caffeine 3. Phenol

Phase Collapse Comparison with Other Brands

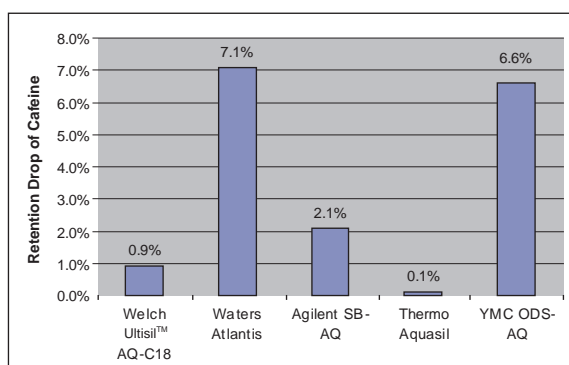

Peak shape is excellent for acid, basic and neutral samples on AQ-C18. When in highly aqueous mobile phase, retention for polar compounds such as organic acids, peptides, nucleosides and water soluble vitamins is strong. Under the same condition, when compared with other brands in highly aqueous mobile phase, Ultisil™ AQ-C18 shows excellent resistance to phase collapse.

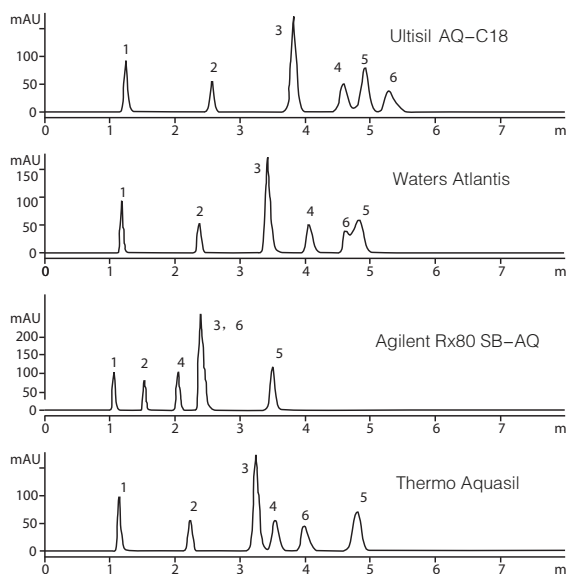

Column:	Ultisil™ AQ-C18, 4.6 × 100 mm, 5 μm
Mobile Phase:	50 mM phosphate, pH2.5
Detector:	210 nm
Temperature:	25 °C
Flow Rate:	1.0 ml/min
Samples:	1. Oxalic acid 2. Lactic acid 3. Maleic acid 4. Citric acid 5. Fumaric acid 6. Succinic acid

How to Choose XB-C18 or AQ-C18?

XB-C18	AQ-C18
<ul style="list-style-type: none"> • Suitable for separation of most pharmaceuticals, environment and chemical compounds • Excellent peak shape for basic and polar samples 	<ul style="list-style-type: none"> • Suitable for water soluble strong polar samples, such as traditional Chinese medicine ingredients, food, beverage, organic acids, peptides, nucleosides and water solution vitamins • Best choice for mobile phase that contains <20% organic content

Ordering Information

Dimensions	AQ-C18	
	3 μm	5 μm
2.1×30 mm	00207-21009	00207-31009
2.1×50 mm	00207-21010	00207-31010
2.1×100 mm	00207-21012	00207-31012
2.1×150 mm	00207-21014	00207-31014
2.1×200 mm	00207-21015	00207-31015
2.1×250 mm	00207-21016	00207-31016
4.6×50 mm	00207-21037	00207-31037
4.6×100 mm	00207-21039	00207-31039
4.6×150 mm	00207-21041	00207-31041
4.6×200 mm	00207-21042	00207-31042
4.6×250 mm	00207-21043	00207-31043
4.6×300 mm	00207-21044	00207-31044

Welch provides 120 Å and 300 Å pore size packing materials. Please contact Welch or your local distributor for other dimensions.

Ultisil™ LP Series HPLC Column

LP is abbreviation for Low pH. LP phases are designed for use at low pH conditions. LP phase consists of two very bulky hydrophobic protective groups to prevent siloxane bond from hydrolysis at low pH condition. So Ultisil™ LP column is extremely stable in very low pH mobile phase and at high temperature, even at the lowest pH of 1.0, making it the most stable C18 for low pH application in the market. Because it is not endcapped and has more surface silanols, LP phase has more retention for some early eluted polar compounds, and provides different selectivities than does traditional C18. Ultisil™ LP-C18 is the most polar C18 among all the C18 products of Welch.

- Not endcapped, prevents siloxane bond from hydrolysis at low pH condition.
- Compatible with 100% water as the mobile phase, more polar than "AQ", better peak shape and resolution
- Best peak shape for polar compounds
- Exceptional lifetime at low pH (0.5-8.0) and high temperature
- 300 Å LP-C18 is exclusively used for separation of polypeptide and protein

**When pH<5.0, based on your separation conditions, you may choose either LP-C18 or XB-C18;
When pH<2.0 (such as 0.1%TFA), LP-C18, which provides exceptional stability, longer lifetime, perfect peak shape and superior selectivity, is your best choice**

PNS (Panax Notoginseng Saponins) Finger-print

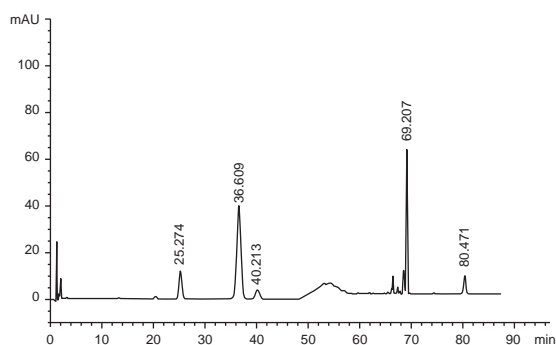

Column:	Ultisil™ LP-C18, 4.6 ×150 mm, 5 μm		
Mobile Phase:	A:ACN B:H ₂ O		
Gradient Program:	Time(min)	A(%)	B(%)
	0	20	80
	45	20	80
	65	34	66
	85	34	66
	86	90	10
	96	90	10
	97	20	80
Flow Rate:	1.0 ml/min		
Detector:	203 nm		
Temperature:	30 °C		
Injection Volume:	10 μl		

Analysis of Gentamicin Sulphate

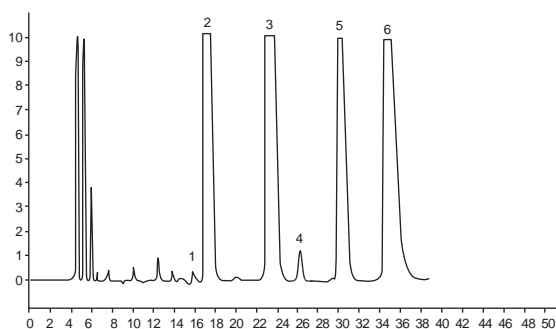

Column:	Ultisil™ LP-C18, 4.6 ×250 mm, 5 μm		
Mobile Phase:	0.2 mol/l TFA:methanol=92:8		
Detector:	ELSD		
Temperature:	110 °C		
Gas Flow Rate:	2.8 l/min		
Flow Rate:	0.6 ml/min		
Injection Volume:	20 μl		
Samples:	1. Sisomicin 2. Gentamicin C1a 3. C2 4. Micronomicin 5. C2a 6. C1		

Analysis of Isoquinoline Alkaloid

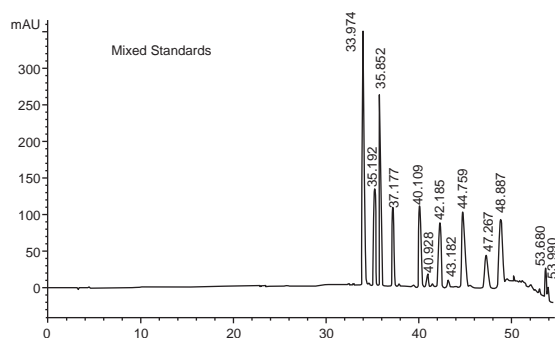

Column:	Ultisil™ LP-C18, 4.6 ×250 mm, 5 μm		
Mobile Phase:	A:0.2% HAC, pH 4.0, adjust with triethylamine B:MeOH		
Gradient Program:	Time(min)	A(%)	B(%)
	0	85	15
	5	85	15
	25	75	35
	30	65	35
	35	60	40
	60	0	100
Flow Rate:	1.0 ml/min		
Detector:	240 nm		
Temperature:	30 °C		
Injection Volume:	20 μl		

Analysis of Thymalfasin

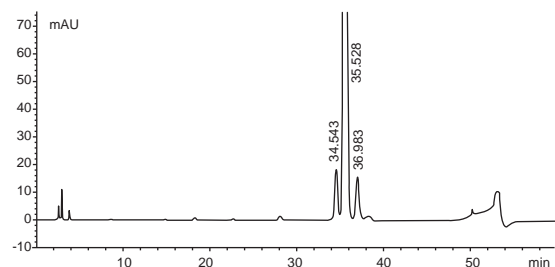

Column:	Ultisil™ LP-C18, 4.6 ×250 mm, 5 μm		
Mobile Phase:	(NH ₄) ₂ SO ₄ buffer: (NH ₄) ₂ SO ₄ 26.4 g, H ₃ PO ₄ 25 ml, dissolved in water to 2000 ml A:(NH ₄) ₂ SO ₄ buffer:ACN=90:10 B:(NH ₄) ₂ SO ₄ buffer:ACN=50:50		
Gradient Program:	Time(min)	A(%)	B(%)
	0	88	12
	45	82	20
	50	50	50
	60	88	12
Flow Rate:	1.0 ml/min		
Detector:	210 nm		
Temperature:	50 °C		
Injection Volume:	20 μl		

Ordering Information

Minibore Column

Dimensions	3 μm		5 μm	
	LP-C18	LP-C8	LP-C18	LP-C8
2.1×30 mm	00208-21009	00209-21009	00208-31009	00209-31009
2.1×50 mm	00208-21010	00209-21010	00208-31010	00209-31010
2.1×100 mm	00208-21012	00209-21012	00208-31012	00209-31012
2.1×150 mm	00208-21014	00209-21014	00208-31014	00209-31014
2.1×200 mm	00208-21015	00209-21015	00208-31015	00209-31015
2.1×250 mm	00208-21016	00209-21016	00208-31016	00209-31016

Analytical Column

Dimensions	3 μm		5 μm	
	LP-C18	LP-C8	LP-C18	LP-C8
4.6×50 mm	00208-21037	00209-21037	00208-31037	00209-31037
4.6×100 mm	00208-21039	00209-21039	00208-31039	00209-31039
4.6×150 mm	00208-21041	00209-21041	00208-31041	00209-31041
4.6×200 mm	00208-21042	00209-21042	00208-31042	00209-31042
4.6×250 mm	00208-21043	00209-21043	00208-31043	00209-31043
4.6×300 mm	00208-21044	00209-21044	00208-31044	00209-31044

Welch provides 120 Å, 300 Å pore size packing materials. Please contact Welch or your local distributor for other dimensions.

Ultisil™ Plus C18 HPLC Column

Ultisil™ Plus C18 HPLC Column is a new generation of C18 column introduced by Welch. Plus C18 adopts unique bonding technique and double endcapping technique, leading to excellent peak shape, separation efficiency, stability and reproducibility.

- USP listing: L1
- pH Range: 2.0-8.0
- Surface Area: 160 m²/g
- Pore Size: 130 Å
- Carbon Loading: 10%

Analysis of ROX (Roxithromycin)

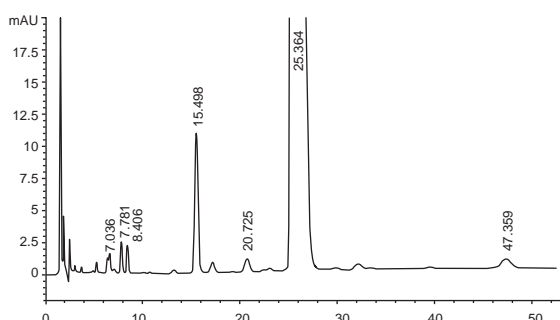

Column:	Ultisil™ Plus C18, 4.6 ×150 mm, 5 μm		
Mobile Phase:	A:Buffer:ACN=74:26 B:water:ACN=30:70		
Gradient Program:	Time(min)	A(%)	B(%)
	0	100	0
	50	100	0
	51	90	10
	80	90	10
	81	100	0
	100	100	0
Flow Rate:	1.0 ml/min		
Detector:	205 nm		
Temperature:	15 °C		
Injection Volume:	20 μl		

Analysis of PNS (Panax Notoginseng Saponins)

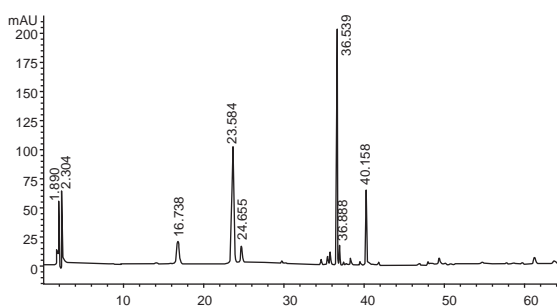

Column:	Ultisil™ Plus C18, 4.6 ×250 mm, 5 μm		
Mobile Phase:	A:ACN B:water		
Gradient Program:	Time(min)	A(%)	B(%)
	0~20	20	80
	20~45	20~46	80~54
	45~55	46~55	54~45
	55~60	55	45
Flow Rate:	1.5 ml/min		
Detector:	203 nm		
Temperature:	25 °C		
Injection Volume:	20 μl		

Ordering Information

Dimensions	P/N
5 μm, 4.6×150 mm	00260-31041
5 μm, 4.6×250 mm	00260-31043

Ultisil™ ALK-C18 HPLC Column

Ultisil™ ALK-C18 is a new generation of C18 column introduced by Welch. In this column, hydrophilic groups are bonded into the silica surface, where large number of silanol groups are replaced, reducing the interactions between basic samples and the silanol groups. As a consequence, the selectivity of ALK-C18 is different from that of traditional C18.

Features:

- Mixed solid phase with both hydrophobic and electrostatic interactions
- Excellent peak shape for basic compounds
- Fast separation of similar samples on a column

USP listing: L1
 pH Range: 1.5-10.0
 Surface Area: 320 m²/g
 Pore Size: 120 Å
 Carbon Loading: 12%

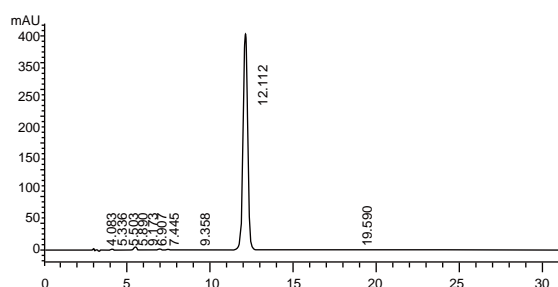
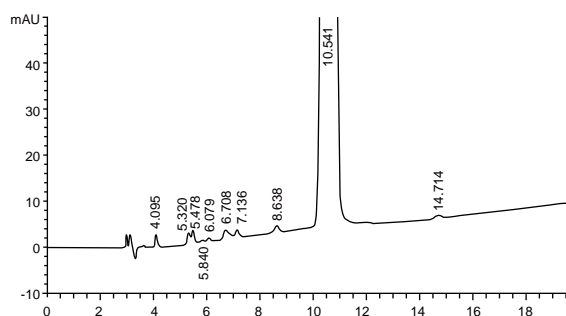
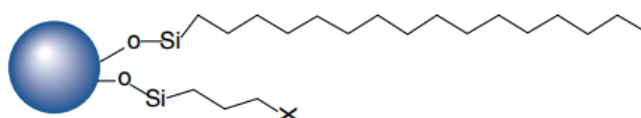

Column:	Ultisil™ ALK-C18, 4.6 ×250 mm, 5 μm		
Mobile Phase:	A:0.5 mol/l KH ₂ PO ₃ [adjust pH to 3.5 with H ₃ PO ₄):MeOH:water=10:30:60 B:0.5 mol/l KH ₂ PO ₃ [adjust pH to 3.5 with H ₃ PO ₄):MeOH:water=10:50:40		
Gradient Program:	Time(min)	A(%)	B(%)
	0	70	30
	20	0	100
	35	0	100
	50	70	30
Flow Rate:	1.0 ml/min		
Detector:	225 nm		
Temperature:	30 °C		
Injection Volume:	20 μl		

Ordering Information

Dimensions	P/N
5 μm, 4.6×150 mm	00253-31041
5 μm, 4.6×250 mm	00253-31043

Ultisil™ Polar Embedded HPLC Column

Ultisil™ polar embedded phases have been developed for more than 10 years. Earlier polar embedded phase is developed with amide phase. The polar functional group close to the surface increases the wettability of this phase, thus decreasing phase collapse, making this phase compatible with mobile phase of up to 95% water content. The polar functional group also shields the effects of unreacted silanol groups, providing excellent peak shape for very polar and strong basic compounds and different selectivity than does C18 phase. Welch provides two kinds of packing materials - Ultisil™ Polar-RP and Ultisil™ Phenyl-Ether.

Ultisil™ Polar-RP HPLC Column

- Excellent with mobile phase of 100% water content, even better than AQ-C18
- Different selectivity than that of AQ-C18
- Excellent peak shape for acidic and basic compounds owing to the "shield" effect of polar linkage to silanol activity by forming hydrogen bonding
- Retentive for polar compounds. Uracil, which can't be retained on most reversed phase columns at 100% water, can be retained on this column, and eluted after 5-fluorocytosine and cytosine. Note that the analysis of purine, pyrimidine, small molecular acids, catecholamine and water soluble vitamins all requires mobile phase with high water content
- Fast separation of similar samples on a column

Comparison of separation of acid compounds

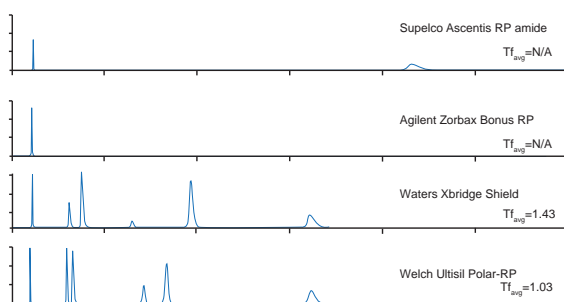

Comparison of separation of base compound

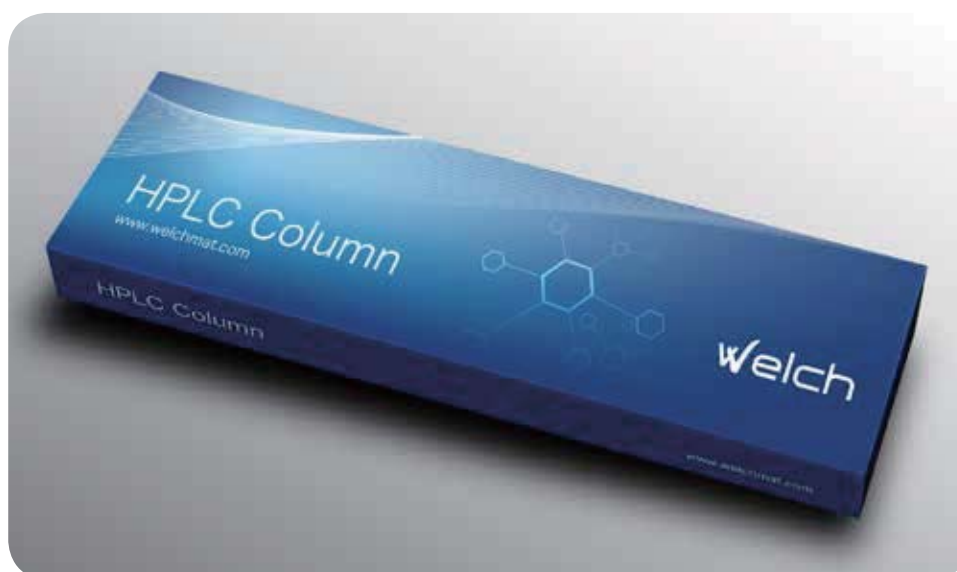
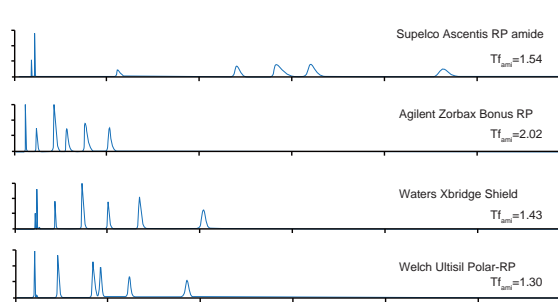

Analysis of Cefradine

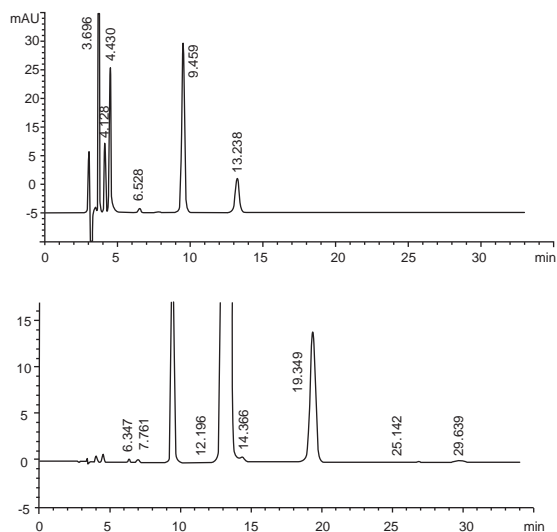

Column:	Ultisil™ Polar RP, 4.6 ×250 mm, 5 μm
Mobile Phase:	MeOH:water:3.86% NaAC:4%HAC=400:1564:30:6
Detector:	254 nm 220 nm
Temperature:	Ambient
Flow Rate:	0.9 ml/min
Injection Volume:	20 μl
Samples:	Impurity reference solution 220 nm 7-ADCA: 3.696 min Dihydrophenylglycine: 4.128 min Cefalexin: 9.495 min Cefradine: 13.238 min

Ultisil™ Phenyl-Ether HPLC Column

- Improved polar & aromatic reversed phases selectivity that complements the more conventional C18 column chemistries
- Better selectivity than phenyl phase for separation of nitrobenzene isomers
- Improved peak shape of highly acidic polar compounds, and different selectivity from other polar phases such as polar embedded phase
- Compatible with 100% water mobile phase

Analysis of Ephedra

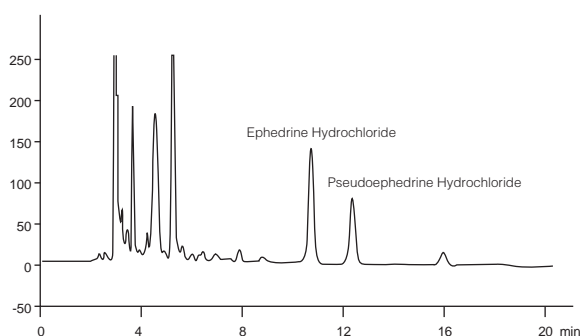

Column:	Ultisil™ Phenyl-Ether, 4.6 ×250 mm, 5 μm
Mobile Phase:	MeOH:0.092% H_3PO_4 solution(contain 0.04% trimethylamine and 0.02% n-butylamine)=1.5:98.5
Detector:	210 nm
Temperature:	Ambient
Flow Rate:	1.0 ml/min
Injection Volume:	10 μl

Ordering Information

Dimensions	Ultisil™ Polar RP	Ultisil™ Phenyl-Ether
5 μm, 4.6×150 mm	00215-31041	00214-31041
5 μm, 4.6×250 mm	00215-31043	00214-31043

Ultisil™ UHPLC Column

Welch also offers Ultisil™ UHPLC (1.8 µm) columns. With high column efficiency and good lot-to-lot reproducibility, Ultisil™ UHPLC can generate high quality data, decreasing the probability of repeated sample analyses while reducing the consumption of solvent at the same time. Ultisil™ UHPLC series offer a variety of bonded phases, specified guard columns and pre-columns for the users to design and realize faster and more environmentally friendly chromatography applications with higher resolution.

Ultra Resolution: same resolution as or better than that of conventional column which has more packing materials

Ultra speed: UHPLC offers more information per unit time and higher speed owing to its smaller particles.

Sensitivity: higher N, narrower peak width (W), higher peak height. The system sensitivity of 1.8 µm UHPLC is 70% and 40% higher than that of conventional column of 5µm and 3.5 µm packings, respectively.

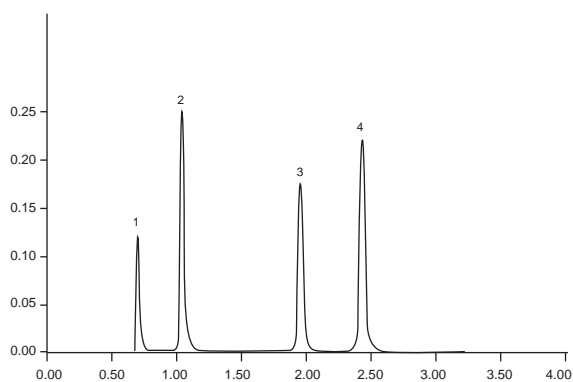
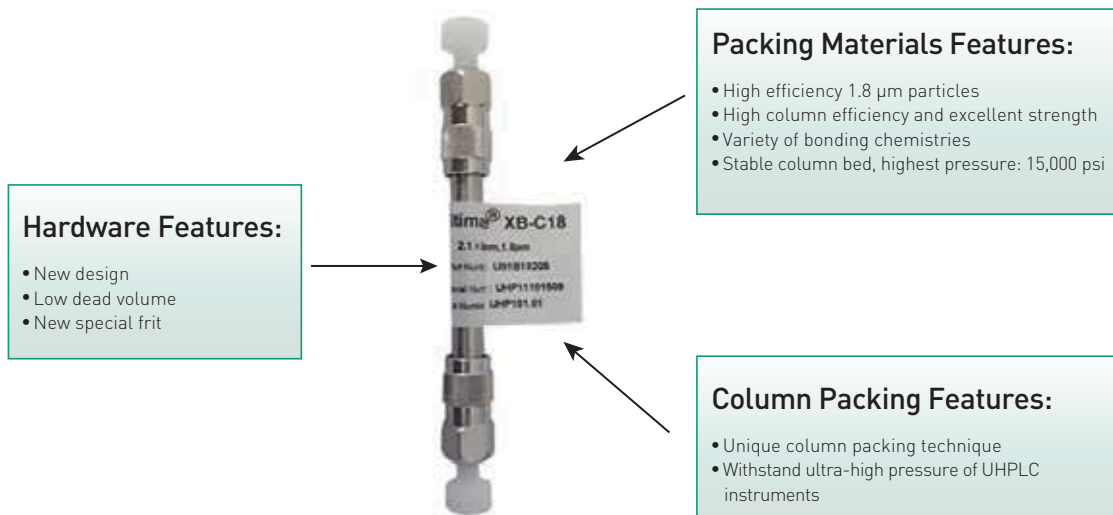

Column:	Ultisil™ UHPLC XB-C18, 2.1 ×100 mm, 1.8 µm
Mobile Phase:	ACN:water=65:35
Detector:	254 nm
Temperature:	Ambient
Flow Rate:	0.35 mL/min
Injection Volume:	2 µl
Back Pressure:	5000 psi
Instrument:	Waters Acquity UPLC
Samples in Order:	Uracil Phenol 4-chloronitrobenzene Toluene

Analysis of Aflatoxin

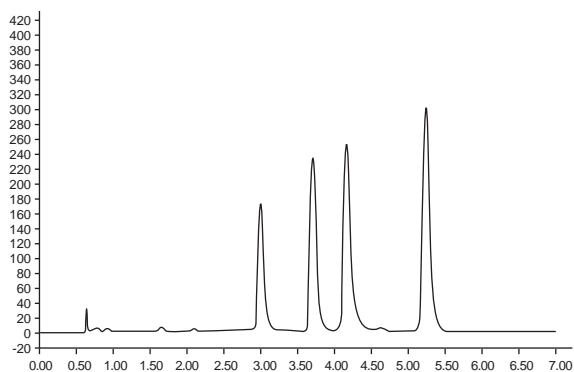

Column:	Ultisil™ UHPLC XB-C18, 2.1×100 mm, 1.8 μm
Mobile Phase:	MeOH:ACN:water=18:18:64
Detector:	FLD Excitation:365 nm Emission:450 nm
Temperature:	35 °C
Flow Rate:	0.35 ml/min
Injection Volume:	2 μl
Instrument:	Waters UPLC
Samples in Order:	G2, G1, B2, B1

Analysis of Telmisartan Tablets

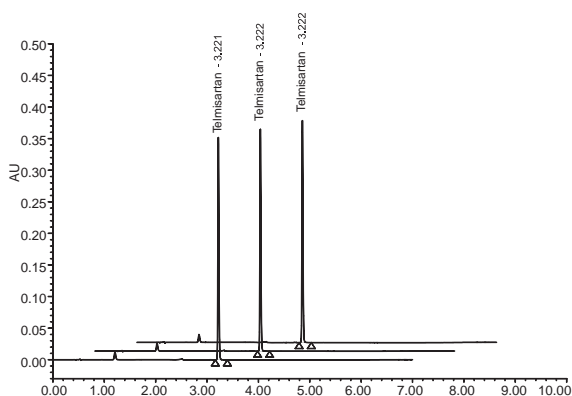

	Sample Name	Retention Time	Area	USP Theoretical Plate Number
1	Telmisartan	3.222	487938	126585
2	Telmisartan	3.222	487646	126607
3	Telmisartan	3.221	488317	126791

Ordering Information

1.8 μm Analytical Column

Dimensions	XB-C18	XB-C8	XB-Phenyl	LP-C18	SiO ₂	Polar RP
2.1×30	00201-11009	00202-11009	00203-11009	00208-11009	00200-11009	00215-11009
2.1×50	00201-11010	00202-11010	00203-11010	00208-11010	00200-11010	00215-11010
2.1×100	00201-11012	00202-11012	00203-11012	00208-11012	00200-11012	00215-11012
2.1×150	00201-11014	00202-11014	00203-11014	00208-11014	00200-11014	00215-11014
4.6×30	00201-11036	00202-11036	00203-11036	00208-11036	00200-11036	00215-11036
4.6×50	00201-11037	00202-11037	00203-11037	00208-11037	00200-11037	00215-11037

Not find the size you want? Contact Welch or your local distributor for other dimensions.

Ultisil™ PAH Column

Ultisil™ PAH Column is a special column recently designed by Welch for the separation of PAHs in EPA method 610. PAHs (Polycyclic Aromatic Hydrocarbon) are hydrocarbons with two or more benzene rings, and considered major pollutants. Therefore the analysis of these potentially carcinogenic compounds in water, air, soil and food takes high priority. Most of PAHs do not exist alone. Substances that may contain PAHs include charcoal, crude oil, creosote, tar, drugs, dyes, plastic, rubber, pesticide, lube, release agent, electrolyte, mineral oil, pitch, insecticide, and bactericide, etc.

16 PAHs:

Naphthalene	Benzo(a)anthracene
Acenaphthylene	Chrysene
Acenaphthene	Benzo(b)fluoranthene
Fluorene	Benzo(k)fluoranthene
Phenanthrene	Benzo(a)pyrene
Anthracene	Indeno(1,2,3-cd)pyrene
Fluoranthene	Dibenzo(a,h)anthracene
Pyrene	Benzo(g,hi)perylene

Ultisil™ PAH columns can separate all 16 PAHs in EPA method 610 rapidly (in less than 30 min) with high resolution. Ultisil™ PAH columns are silica based columns for PAH analysis with the best peak shape.

Analysis of 9 Pesticide Residues in Water

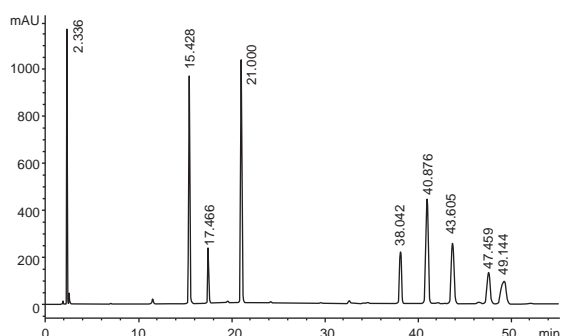

Column:	Ultisil™ PAH, 4.6 ×250 mm, 5 μm
Mobile Phase:	Water:ACN=70:30(0 min) 30:70(30 min)
Detector:	220 nm
Temperature:	30 °C
Flow Rate:	1.0 ml/min
Injection Volume:	10 μl
Mixed Standards:	Melbina, uracil, atrazine, terbuthylazine, estradiol, pendimethalin, fondantone, pyrene, cypermethrin

Separation of 16 PAHs in EPA Method 610

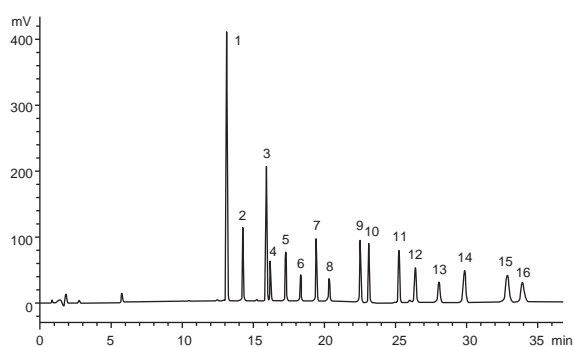

Column:	Ultisil™ PAH, 4.6 ×250 mm, 5 μm
Mobile Phase:	A:water B:ACN Gradient
Detector:	220 nm
Temperature:	Ambient
Flow Rate:	1.5 ml/min
Injection Volume:	10 μl
Mixed Standards:	1. Naphthalene 2. Acenaphthylene 3. Acenaphthene 4. Fluorene 5. Phenanthrene 6. Anthracene 7. Fluoranthene 8. Pyrene 9. Benzo(a)anthracene 10. Chrysene 11. Benzo(b)fluoranthene 12. Benzo(k)fluoranthene 13. Benzo(a)pyrene 14. Dibenzo(a,h)anthracene 15. Benzo(g,hi)perylene 16. Indeno(1,2,3-cd)pyrene

Ordering Information

Dimensions	P/N
3 μm , 4.6 \times 150 mm	00210-21041
3 μm , 4.6 \times 250 mm	00210-21043
5 μm , 4.6 \times 150 mm	00210-31041
5 μm , 4.6 \times 250 mm	00210-31043

Welch provides 120 Å and 300 Å pore size packing materials. Please contact Welch or your local distributor for other dimensions.

Ultisil™ Amino Acid HPLC Column

Welch Ultisil™ Amino Acid HPLC columns are made from spherical, totally porous, and ultra-high purity (>99.999%) type B silica particles. Welch's proprietary technique of surface modification before bonding generates a very smooth and uniform surface with less acidic surface silanol. Ultisil™ Amino Acid columns provide the best performance in peak shape, efficiency and resolution for the analysis of 18 amino acids. Complete sample preparation can be achieved in as little as 30 min.

Ultisil™ Amino Acid Method Package

- Ultisil™ Amino Acid Column (5 μm , 4.6 \times 250 mm), 1 pk
- Amino Acid Standards, 2 bottles. 1 ml/bottle
- Derivatization reagent A
- Derivatization reagent B
- Ultisil™ AA method brochure

Separation of 18 Amino Acids

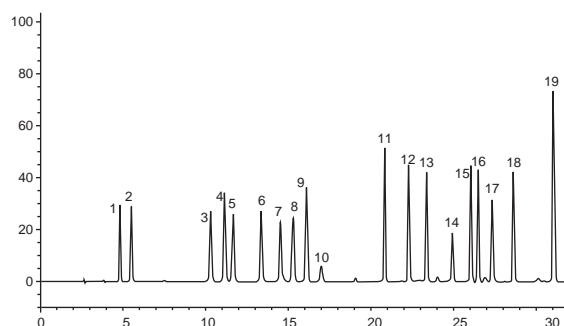

1. Aspartic Acid	2. Glutamic acid
3. Serine	4. Glycine
5. Histidine	6. Arginine
7. Threonine	8. Alanine
9. Proline	10. Ammonium chloride
11. Tyrosine	12. Valine
13. Methionine	14. Cystine
15. Isoleucine	16. Leucine
17. Norleucine	18. phenylalanine
19. Lysine	

Ordering Information

Dimensions	P/N
3 μm , 4.6 \times 150 mm	00211-21041
3 μm , 4.6 \times 250 mm	00211-21043
5 μm , 4.6 \times 150 mm	00211-31041
5 μm , 4.6 \times 250 mm	00211-31043

Not find the size you want? Contact Welch or your local distributor for other dimensions.

Ultisil™ C30 HPLC Column

Carotenoids is a broad class of natural products, of which over 600 types have been found so far, including compounds of different carbon chain length, such as C40, C50 and C30 etc. They are well known to have many biological functions, including cancer prevention and treatment functions.

Compared to classical C18 stationary phases, the C30 phase is much more hydrophobic and retaining. Even when pure organic eluent is applied, many sample solutes, such as carotenoids, are able to retain. Ultisil™ C30 is designed for the separation of geometric isomers, polar carotenes, polar and nonpolar xanthophylls, steroids, retinols and fat-soluble vitamins (A, D, K and E).

- Polymeric C30 alkyl chains
- High lipophilic
- Exceptional selectivity pattern for geometric isomers
- pH range: 1.5-10

Separation of Carotenoids

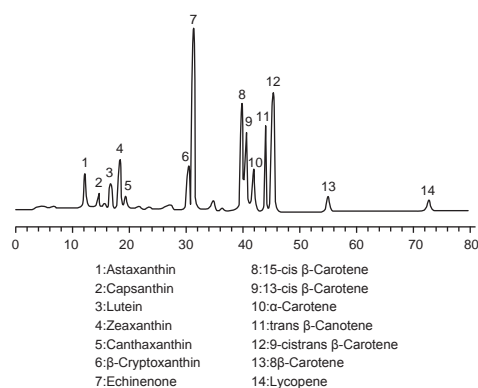

Column:	Ultisil™ C30, 4.6 × 250 mm, 5 μm
Mobile Phase:	A: MeOH:MTBE:H ₂ O=81:15:4 B: MeOH:MTBE=10:90
Gradient Program:	0-90 min (0%B-100%B)
Detector:	450 nm
Temperature:	Ambient
Flow Rate:	1.0 ml/min

Separation of Ursolic Acid and Oleanolic Acid

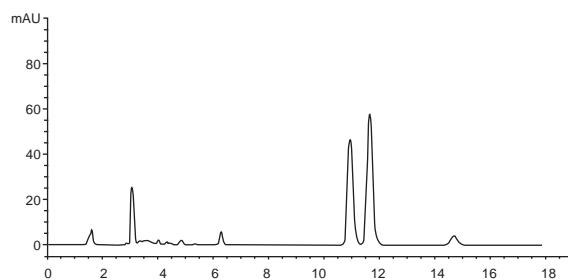

Column:	Ultisil™ C30, 4.6 × 250 mm, 5 μm
Mobile Phase:	ACN:water=93:7
Detector:	210 nm
Temperature:	20 °C
Flow Rate:	1.0 ml/min
Injection Volume:	10 μl

Analysis of All-trans Astaxanthin

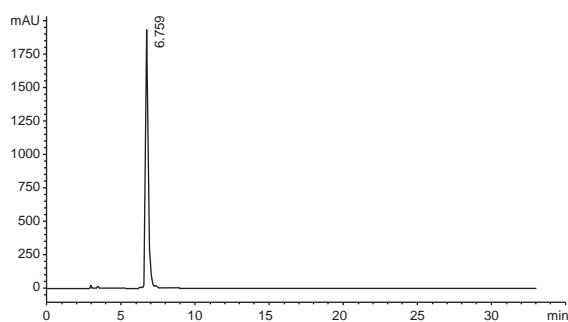

Column:	Ultisil™ C30, 4.6 × 250 mm, 5 μm																		
Mobile Phase:	A: MeOH:1% H ₃ PO ₄ =94:4 B: MeOH:TBME:1% H ₃ PO ₄ =16:80:4																		
Gradient Program:	<table border="1"> <thead> <tr> <th>Time(min)</th> <th>A(%)</th> <th>B(%)</th> </tr> </thead> <tbody> <tr> <td>0</td> <td>67</td> <td>23</td> </tr> <tr> <td>15</td> <td>52</td> <td>48</td> </tr> <tr> <td>23</td> <td>0</td> <td>100</td> </tr> <tr> <td>27</td> <td>67</td> <td>33</td> </tr> <tr> <td>30</td> <td>67</td> <td>33</td> </tr> </tbody> </table>	Time(min)	A(%)	B(%)	0	67	23	15	52	48	23	0	100	27	67	33	30	67	33
Time(min)	A(%)	B(%)																	
0	67	23																	
15	52	48																	
23	0	100																	
27	67	33																	
30	67	33																	
Flow Rate:	1.0 ml/min																		
Detector:	474 nm																		
Temperature:	30 °C																		
Injection Volume:	20 μl																		

Ordering Information

Dimensions	P/N
3 μ m, 4.6×150 mm	00223-21041
3 μ m, 4.6×250 mm	00223-21043
5 μ m, 4.6×150 mm	00223-31041
5 μ m, 4.6×250 mm	00223-31043

Not find the size you want? Contact Welch or your local distributor for other dimensions.

Ultisil™ Fluorinated Phase HPLC Column

Ultisil™ Fluorinated Phase has high selectivity and increased retention toward closely related compounds, including both aromatic fluorinated compounds and other nonaromatic halogenated compounds. It can be used in reversed phase and provides an alternative and complementary separation to that performed on C8 or C18 columns for many analytes. Fluorinated phase has better separation for ionic and polar compounds than do alkyl phases. Fluorinated phase can provide different elution orders, leading to enhanced selectivity for compounds that are difficult to separate.

Ultisil™ PFP HPLC Column

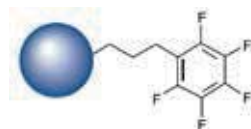

Ultisil™ PF-Phenyl is a phase primarily used in the separation of molecules bearing fluorine atoms, but may also be in the separation of non-fluorinated compounds such as Taxol and its derivatives. Because of its phenyl ring, it has a higher selectivity for aromatic molecules than for other alkyl-fluorinated phases. Ultisil™ PF-Phenyl can separate nitro-benzene isomers (para vs. ortho), which cannot be separated by conventional phenyl phase.

Analysis of Taxol

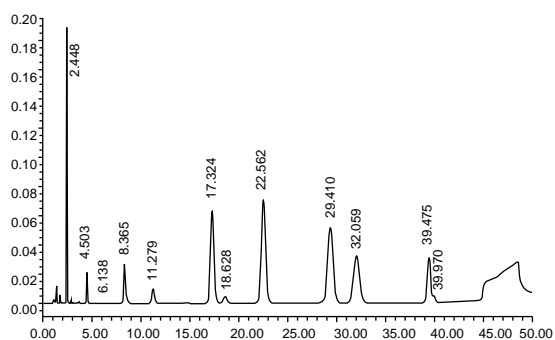

Column:	Ultisil™ PFP, 4.6 ×250 mm, 5 μ m		
Mobile Phase:	A: ACN B: water		
Gradient Program:	Time(min)	A(%)	B(%)
	0	35	65
	35	35	65
	60	80	20
	70	85	15
	80	85	65
Flow Rate:	2.6 ml/min		
Detector:	227 nm		
Temperature:	30 °C		
Injection Volume:	10 μ l		

Ultisil™ F-C8 HPLC Column

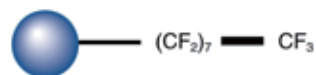

Ultisil™ F-C8 column has high selectivity and increased retention toward halogenated aromatic and alkyl compounds, but different from octyl alkyl phase.

Toraseamide

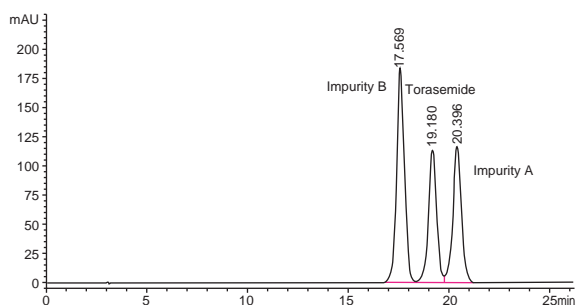

Column:	Ultisil™ F-C8, 4.6 ×250 mm, 3 μm
Mobile Phase:	0.02 mol/l KH ₂ PO ₄ (pH 7.0)/MeOH=65/35
Flow Rate:	1.0 ml/min
Detector:	288 nm
Temperature:	30 °C
Injection Volume:	20 μl
Notes:	Be sensitive to mobile phase pH

Analysis of DT Impurities

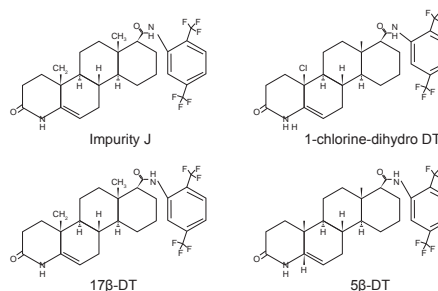
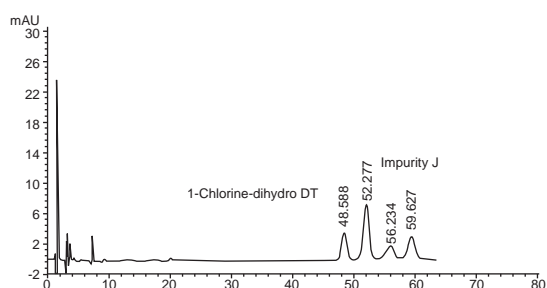

Column:	Ultisil™ F-C8, 4.6 ×250 mm, 3 μm
Mobile Phase:	MeOH/ACN/water=54/6/40
Flow Rate:	1.0 ml/min
Detector:	288 nm
Temperature:	Ambient
Injection Volume:	10 μl

Ordering Information

Dimensions	Ultisil™ PFP	Ultisil™ F-C8
5 μm, 4.6×150 mm	00224-31041	00222-31041
5 μm, 4.6×250 mm	00224-31043	00222-31043

Ultisil™ Mixed Mode Phase

Ultisil™ Mixed mode phase, whose selectivity is totally different from conventional reversed phase, is a new packing material that is the development trend of liquid chromatography. There are three modes in the mixed mode phase: reversed phase/anion exchange, reversed phase/cation exchange, reversed phase/amphoteric compound.

- Different selectivity from reversed phase/anion exchange column
- Can separate strong polar compounds without using ion-pair agent
- Separate positive compounds, negative compounds and neutral compounds simultaneously
- Appropriate for MS analysis

Ultisil™ MM C18/SCX

- Ultra-pure spherical porous silica
- Can be used for separation of hydrophobic and ion compounds
- Best choice for analysis of unknown samples, especially metabolites
- The first mixed column in China

Analysis of Melamine

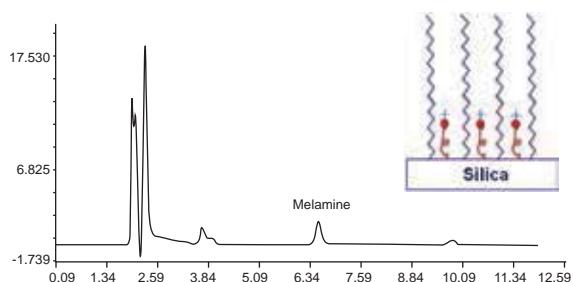

Column:	Ultisil™ MM C18/SCX, 4.6 × 250 mm, 5 μm
Mobile Phase:	0.01 M NH ₄ AC(pH3.0):ACN=62:38
Detector:	240 nm
Temperature:	40 °C
Flow Rate:	1.0 ml/min
Injection Volume:	20 μl

Ultisil™ MM NH₂/CN

- Hilic Mode
- Base on ultra-pure spherical porous silica
- Appropriate for analysis of sugars that are hard to separate

Separation of Lactose and Galactose

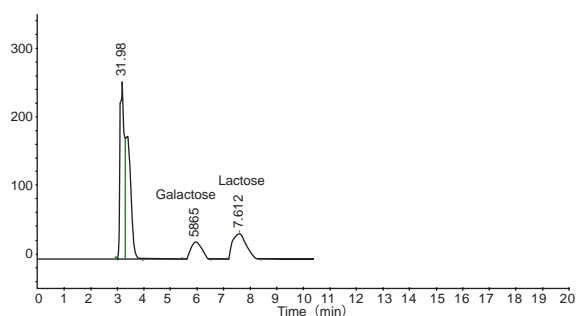

Column:	Ultisil™ MM NH ₂ /CN, 4.6 × 250 mm, 5 μm
Mobile Phase:	ACN:water =70:30
Detector:	RID (40 °C)
Temperature:	45 °C
Flow Rate:	1.0 ml/min
Injection Volume:	20 μl

Ordering Information

5 μm Analytical Column

Dimensions	MM C18/SCX	MM NH ₂ /CN
2.1×50	00235-31010	00243-31010
2.1×100	00235-31012	00243-31012
2.1×150	00235-31014	00243-31014
4.6×150	00235-31041	00243-31041
4.6×250	00235-31043	00243-31043

Ultisil™ HILIC Column

HILIC (Hydrophilic Interaction Liquid Chromatography) is a separation mode achieved through the partitioning of polar solutes from high concentration, water-miscible, organic mobile phase into hydrophilic surface environment.

Ultisil™ HILIC Amide

Ultisil™ HILIC Amide column is a special column designed for HILIC mode. As amide group has strong hydrophilicity, stability and electrically neutral, Ultisil™ Amide has longer life, better separation repeatability and peak shape than NH₂ phase does.

- Based on silica bonded with amide groups, appropriate for the separation of hydrophilic samples
- Multiple actions such as hydrogen bond, molecular and electrostatic interactions
- Good compatibility with many kinds of detectors, such as MS detector
- Stable in organic mobile phase that contains water

Fructo-oligose

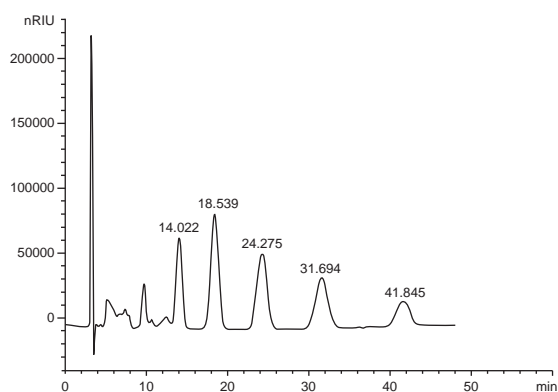

Column:	Ultisil™ HILIC Amide, 4.6 × 250 mm, 5 μm
Mobile Phase:	ACN:water =70:30
Detector:	RID (40 °C)
Temperature:	40 °C
Flow Rate:	1.0 ml/min
Injection Volume:	20 μl
Mixed Standards:	Sucrose, kestose, nystose, megazyme, 1F-Fructofuranosyl nystose)



Ultisil™ Chiral Column

Ultisil™ Chiral Columns are based on spherical silica particles coated with chiral polymers (amylose derivatives or cellulose derivatives). Welch offers 5 μm and 10 μm particles, and four types of chiral columns: Cellu-D, Cellu-J, Amy-D and Amy-s. 80% of all racemic compounds can be separated by these four chiral columns.

Cellu-D/Cellu-DR:

Cellulose tris (3,5-dimethylphenylcarbamate) coated silica

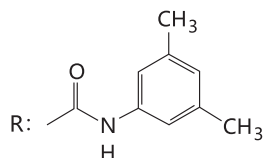
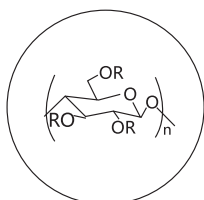

Cellu-J/Cellu-JR:

Cellu-J/Cellu-JR: Cellulose tris (4-methyl benzoate) coated silica

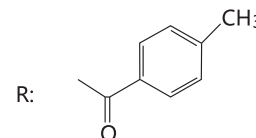
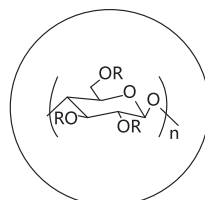

Amy-D/Amy-DR:

Amylose tris (3,5-dimethylphenylcarbamate) coated silica

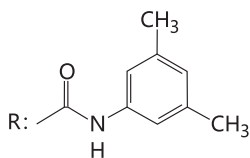
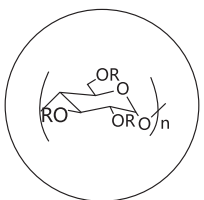

Amy-S/Amy-SR:

Amylose tris [(S)- α -methylphenyl carbamate] coated Silica

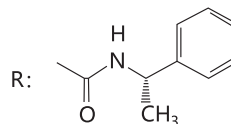
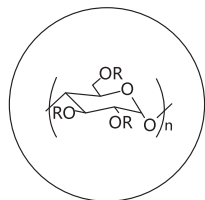

Fenamiphos

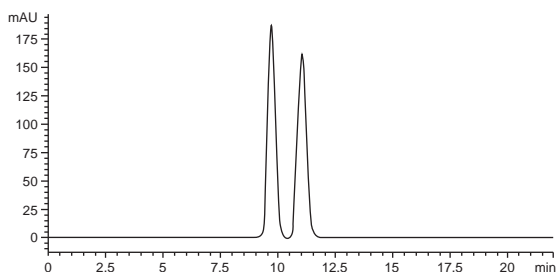

Column:	Ultisil™ Amy-D
Mobile Phase:	N-hexane: EtOH=90:10

Tröger's Base

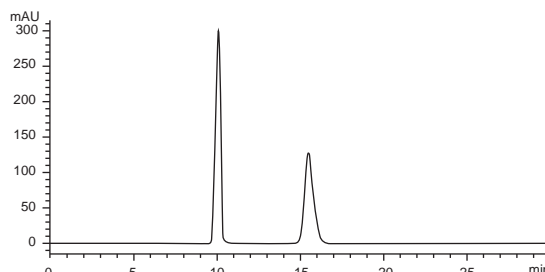

Column:	Ultisil™ Cellu-J
Mobile Phase:	N-hexane: isopropanol=90:10

DL-Repaglinide

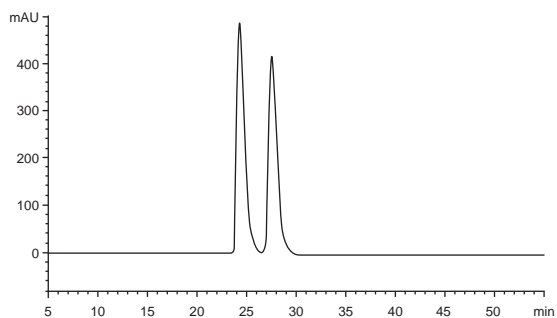

Column:	Ultisil™ Cellu-D
Mobile Phase:	N-hexane: EtOH:TFA=90:10:0.1

Myclobutanil

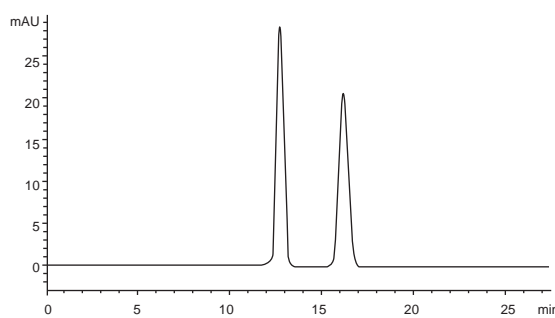

Column:	Ultisil™ Amy-S
Mobile Phase:	N-hexane: EtOH=90:10

Quizalofop-ethyl

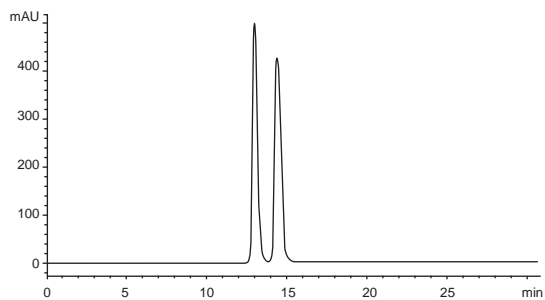

Column:	Ultisil™ Amy-D
Mobile Phase:	N-hexane: EtOH =95:5

Oxirane,2-[(phenylmethoxy)methyl]-

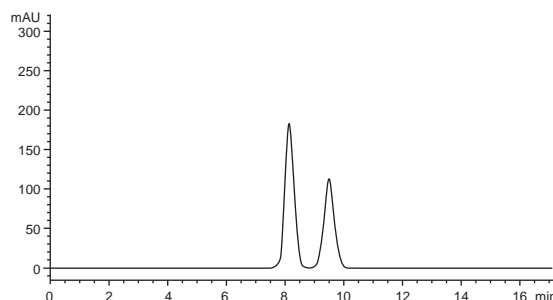

Column:	Ultisil™ Amy-S
Mobile Phase:	N-hexane: isopropanol =98:2

Llaprazole

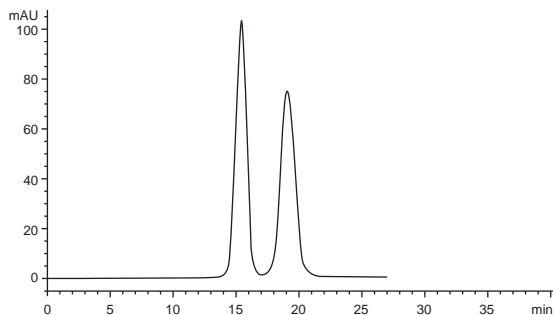

Column:	Ultisil™ Cellu-JR
Mobile Phase:	MeOH: H ₂ O =80:20

Omeprazole

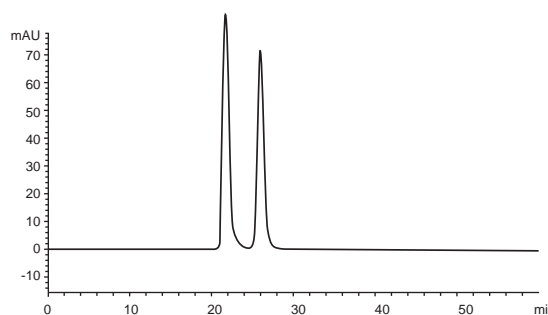

Column:	Ultisil™ Amy-D
Mobile Phase:	N-hexane: isopropanol =83:17

Alkannin

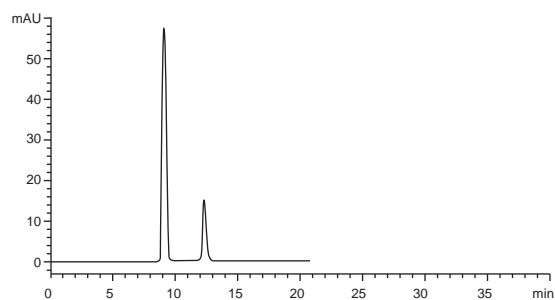

Column:	Ultisil™ Cellu-D
Mobile Phase:	N-hexane: isopropanol:TFA =90:10:0.1

Fmoc-Leu-OH

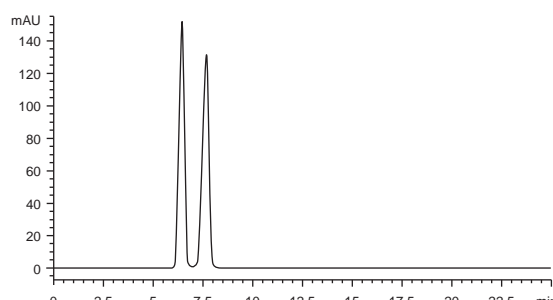

Column:	Ultisil™ Cellu-DR
Mobile Phase:	MeOH: (pH=2.0 H ₃ PO ₄)water =95:5

Butylphthalide

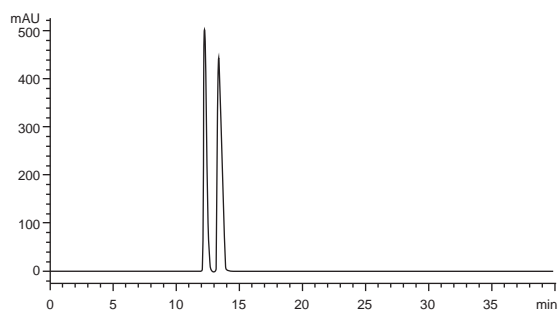

Column:	Ultisil™ Cellu-D
Mobile Phase:	N-hexane: isopropanol =98:2

Hexaconazole

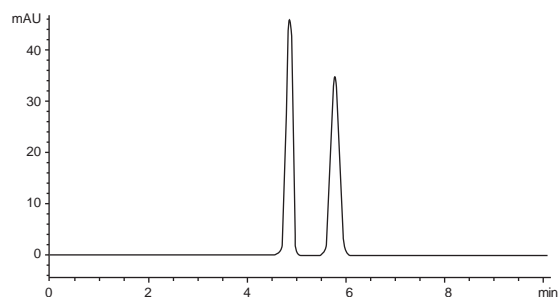

Column:	Ultisil™ Amy-S
Mobile Phase:	N-hexane: isopropanol =90:10

Ordering Information

Dimensions	Cellu-D	Amy-D	Cellu-J	Amy-S	Cellu-DR	Amy-DR	Cellu-JR	Amy-SR
5 µm, 4.6×150 mm	00219-31041	00221-31041	00218-31041	00220-31041	00262-31041	00264-31041	00261-31041	00263-31041
5 µm, 4.6×250 mm	00219-31043	00221-31043	00218-31043	00220-31043	00262-31043	00264-31043	00261-31043	00263-31043
10 µm, 4.6×150 mm	00219-41041	00221-41041	00218-41041	00220-41041	00262-41041	00264-41041	00261-41041	00263-41041
10 µm, 4.6×250 mm	00219-41043	00221-41043	00218-41043	00220-41043	00262-41043	00264-41043	00261-41043	00263-41043
5 µm, 10×150 mm	02682-21101	02684-21101	02681-21101	02683-21101	02686-21101	02688-21101	02685-21101	02687-21101
5 µm, 10×250 mm	02682-21102	02684-21102	02681-21102	02683-21102	02686-21102	02688-21102	02685-21102	02687-21102
10 µm, 10×150 mm	02682-31101	02684-31101	02681-31101	02683-31101	02686-31101	02688-31101	02685-31101	02687-31101
10 µm, 10×250 mm	02682-31102	02684-31102	02681-31102	02683-31102	02686-31102	02688-31102	02685-31102	02687-31102
5 µm, 20×150 mm	02682-21131	02684-21131	02681-21131	02683-21131	02686-21131	02688-21131	02685-21131	02687-21131
5 µm, 20×250 mm	02682-21132	02684-21132	02681-21132	02683-21132	02686-21132	02688-21132	02685-21132	02687-21132
10 µm, 20×150 mm	02682-31131	02684-31131	02681-31131	02683-31131	02686-31131	02688-31131	02685-31131	02687-31131
10 µm, 20×250 mm	02682-31132	02684-31132	02681-31132	02683-31132	02686-31132	02688-31132	02685-31132	02687-31132

Xtimate[®] Series HPLC Column

---Next generation beyond mid-range Ultisil[™] series

X features of Xtimate[®] column

eXtra pH range: wide pH range from 1.0 to 12.5, excellent peak shape for strong bases

eXtra column lifetime: 5 times of similar product such as Gemini

eXtra performance: column efficiency of 5 μm columns is as high as 90,000/m, 2-3 times of that of Xterra

eXtra care from Welch: enjoy excellent pre-sales and after-sales service from Welch

Xtimate[®] Silica Based HPLC Column

Xtimate[®] HPLC column derives its outstanding performance from a special hybrid particle based technique, which coats a unique 5 nm organic/inorganic polymer layer on the silica surface, so that the pH range is extended to 1.0-12.5.

Xtimate[®] column is designed for HPLC method development. Regardless of the types of mobile phase or high temperature, Xtimate[®] HPLC column always has stable performance and long lifetime.

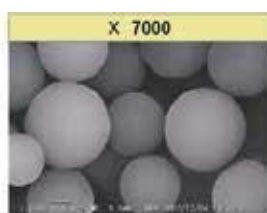

SEM of Hybrid particle

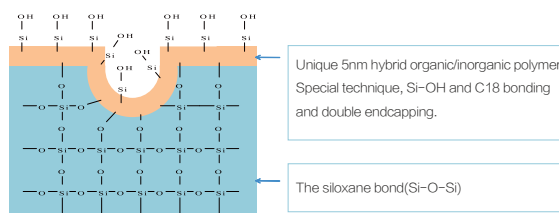

Hybrid Particles Based Xtimate[®] Technology

Comparison of Peak Shape After Soaking In Base

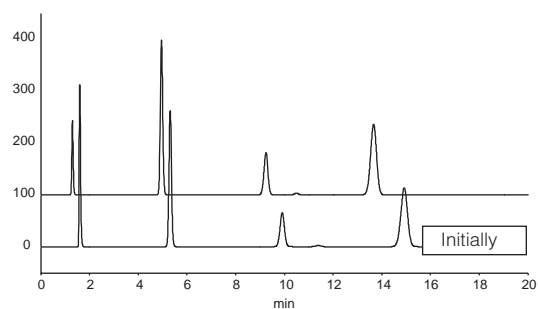

Column:	Xtimate [®] C18, 5 μm , 150 x 4.6 mm
Mobile Phase:	CH ₃ CN/0.01N NaOH aq. (pH=12)=30/70
Flow Rate:	1.0 ml/min
Temperature:	40 °C
Soak Time:	4 hours

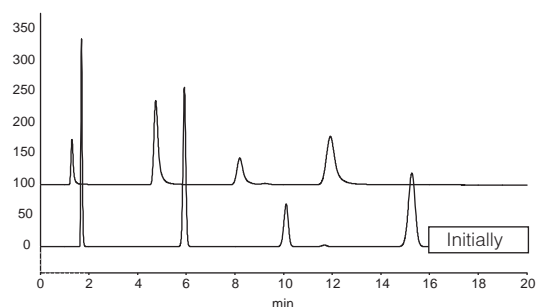

Column:	Ultisil [™] C18, 5 μm , 150 x 4.6 mm
Mobile Phase:	CH ₃ OH/H ₂ O=60/40
Flow Rate:	1.0 ml/min
Temperature:	40 °C
Detector:	UV 254 nm
Samples:	1.Uracil 2.Methyl benzoate 3.Toluence 4.Naphthalene

After test at pH 12 condition for 4h, the peak shape of hybrid particles based Xtimate[®] column shows little difference.

Lifetime Test Comparison: 5 Times Longer Than Gemini

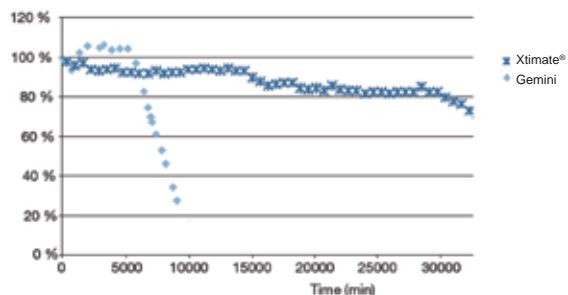

Column:	Xtimate® C18, 5 µm, 150x4.6 mm / Gemini C18, 5 µm, 150x4.6 mm
Mobile Phase:	A: 10 mM Ammonium Bicarbonate pH 10.5 B: 90:10 Acetonitrile/buffer
Gradient Program:	0% to 100% B in 10 min. 100% B for 7 min. 0% B for 3 min.
Flow Rate:	1.0 ml/min
Temperature:	50 °C
Detector:	UV 254 nm
Samples:	1.Uracil 2.Methyl benzoate 3.Toluence 4.Naphthalene

Unprecedented Peak Shape

At mid pH, strong bases usually exhibit bad tailing due to secondary interactions between the analytes and the surface silanols. In Welch’s unique technique, the hybrid layer totally covers the surface silanols and blocks analytes’ access to these surface silanols. Improved bonding and endcapping further reduce silanol activity. As a result, hybrid particle based Xtimate® columns show unprecedented peak.

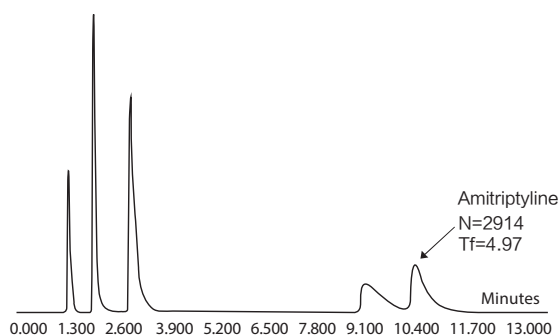

The detection of amitriptyline by poor endcapping product

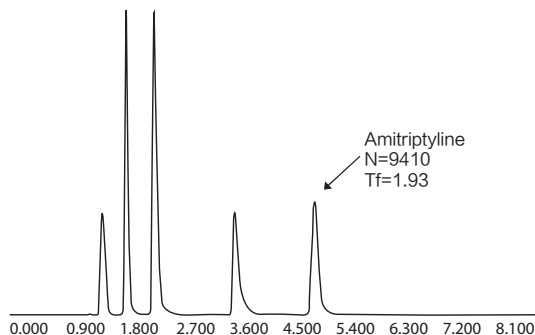

The detection of Amitriptyline by Symmetry C18

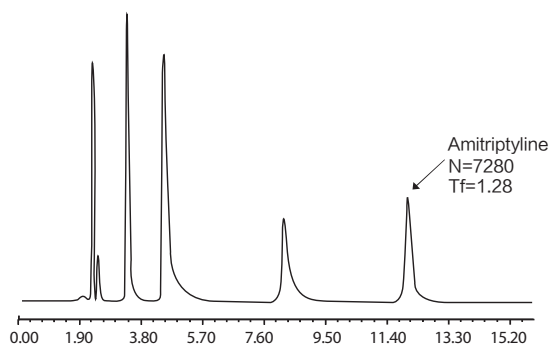

The detection of amitriptyline by Xtimate® C18



Xtimate® HPLC Column Bonded Phases

Besides C18 and C8 bonded phases, Xtimate also provides C4, CN, Phenyl bonded phases.

Xtimate® applies a new special Smoothpak™ technique to C18, C8, C4, CN, Phenyl and amino phases, different than the bonding method of other series. As a result, Xtimate® provides a different selectivity, improved stability and reproducibility. In particular, for the Phenyl phase of Phenyl-Hexyl, Xtimate® is totally different from Ultisil™ Phenyl. Xtimate® Phenyl phase's longer hexyl group provides extra hydrocarbon interaction and longer retention than conventional phenyl-propyl phase; it also provides better chemical stability.

Welch also adds polar embedded phase, Polar-RP on Xtimate® particles, to further improve peak shape for very polar and strong basic compounds and provides different selectivity than does C18 phase.

Solifenacin Succinate

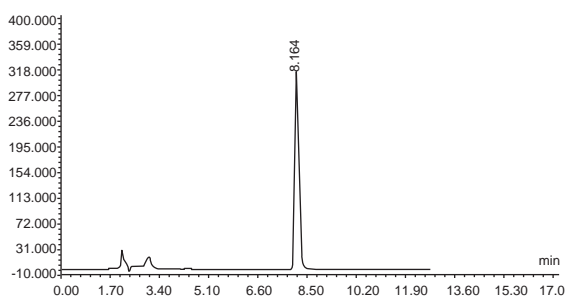
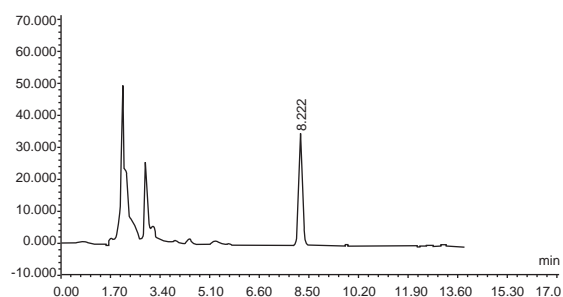

Column:	Xtimate® C18, 5 µm, 250 x 4.6 mm
Mobile Phase:	50 mmol/l K ₂ HPO ₄ (pH3.0):ACN=60:40
Flow Rate:	1.0 ml/min
Temperature:	40 °C
Detector:	UV 210 nm
Injection Volume:	20 µl

Valaciclovir Hydrochloride

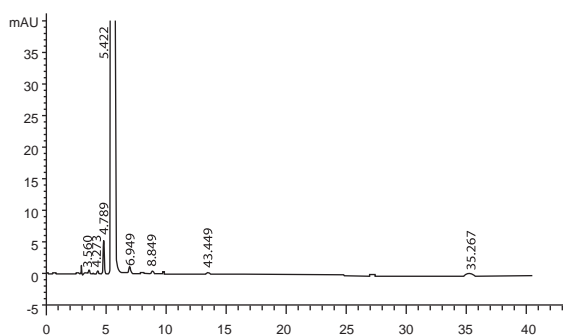

Column:	Xtimate® Phenyl-Hexyl, 5 µm, 250 x 4.6 mm
Mobile Phase:	MeOH:0.01 mol/l KH ₂ PO ₄ (pH3.0)=15:85
Flow Rate:	1.0 ml/min
Temperature:	35 °C
Detector:	251 nm
Injection Volume:	20 µl

Omeprazole

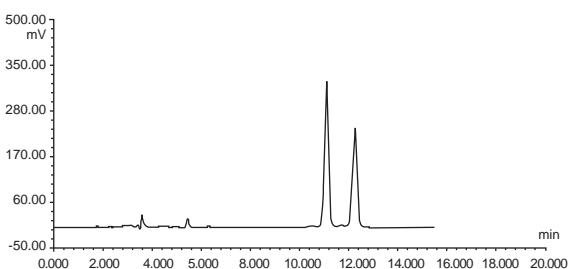

Column:	Xtimate® C8, 5 µm, 250 x 4.6 mm
Mobile Phase:	10 mmol/l Na ₂ HPO ₄ (pH7.4):ACN=70:30
Flow Rate:	1.0 ml/min
Temperature:	Ambient
Detector:	280 nm
Injection Volume:	20 µl

Enalapril Maleate

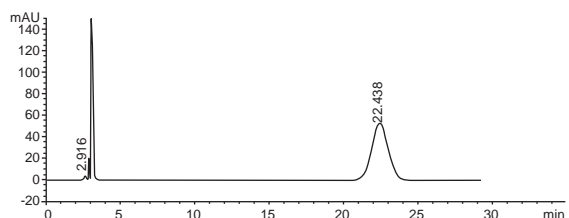
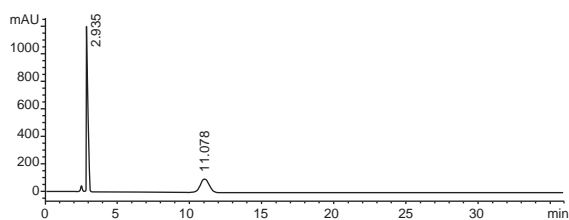

Column:	Xtimate® C8, 5 µm, 250 x 4.6 mm
Mobile Phase:	Phosphate buffer:ACN=75:25
Flow Rate:	1.0 ml/min
Temperature:	50 °C
Detector:	280 nm
Injection Volume:	20 µl

Ordering Information

3 µm Minibore Column

	C18	C8	C4	Phenyl-Hexyl	CN	NH ₂
2.1×30	00101-21009	00102-21009	00107-21009	00104-21009	00105-21009	00103-21009
2.1×50	00101-21010	00102-21010	00107-21010	00104-21010	00105-21010	00103-21010
2.1×100	00101-21012	00102-21012	00107-21012	00104-21012	00105-21012	00103-21012
2.1×150	00101-21041	00102-21041	00107-21041	00104-21041	00105-21041	00103-21041

5 µm Minibore Column

	XB-C18	XB-C8	XB-C4	XB-Phenyl	XB-CN	XB-NH ₂
2.1×30	00101-31009	00102-31009	00107-31009	00104-31009	00105-31009	00103-31009
2.1×50	00101-31010	00102-31010	00107-31010	00104-31010	00105-31010	00103-31010
2.1×100	00101-31012	00102-31012	00107-31012	00104-31012	00105-31012	00103-31012
2.1×150	00101-31041	00102-31041	00107-31041	00104-31041	00105-31041	00103-31041

3 µm Analytical Column

	XB-C18	XB-C8	XB-C4	XB-Phenyl	XB-CN	XB-NH ₂
3.0×30	00101-21018	00102-21018	00107-21018	00104-21018	00105-21018	00103-21018
3.0×50	00101-21019	00102-21019	00107-21019	00104-21019	00105-21019	00103-21019
4.6×50	00101-21037	00102-21037	00107-21037	00104-21037	00105-21037	00103-21037
4.6×150	00101-21041	00102-21041	00107-21041	00104-21041	00105-21041	00103-21041

5 µm Analytical Column

	XB-C18	XB-C8	XB-C4	XB-Phenyl	XB-CN	XB-NH ₂
4.6×50	00101-31037	00102-31037	00107-31037	00104-31037	00105-31037	00103-31037
4.6×100	00101-31039	00102-31039	00107-31039	00104-31039	00105-31039	00103-31039
4.6×150	00101-31041	00102-31041	00107-31041	00104-31041	00105-31041	00103-31041
4.6×250	00101-31043	00102-31043	00107-31043	00104-31043	00105-31043	00103-31043

Not find the size you want? Contact Welch or your local distributor for other dimensions.

Xtimate[®] SEC

Xtimate[®] SEC (size exclusion chromatography), also known as “global protein hydrophilic modified silica column”, is made from ultra-high purity, stable silica bonded with hydrophilic polymer and diol functional groups. This double bonding mechanism, which makes possible of nonspecific adsorption of high Mw polymers, proteins, biological enzymes, polypeptides and other biological samples, can be applied to separating water-soluble polymers from biomacromolecules.

- Ultra-high purity, stable silica bonded with hydrophilic polymer and diol functional groups.
- 5 µm or 3 µm silica microsphere, high separation efficiency
- 120 Å minibore columns fit for analysis of polar compounds such as cephalosporins; 300 Å ones fit for biomacromolecules such as proteins and polypeptides.
- Four pore sizes: 120 Å, 300 Å, 500 Å and 1000 Å.

Phase	Xtimate [®] SEC-120	Xtimate [®] SEC-300	Xtimate [®] SEC-700	Xtimate [®] SEC-1,000
Materials	Silica particles bonding hydrophilic polymer	Silica particles bonding hydrophilic polymer	Silica particles bonding hydrophilic polymer	Silica particles bonding hydrophilic polymer
Particle Size(µm)	5	5	5	5
Pore Size(Å)	120	300	700	1,000
Protein Molecule Range	500-150,000	5,000-1,250,000	15,000-5,000,000	50,000-7,500,000
Soluble Polymer Molecule Mass Range	500-25,000	1,000-100,000	2,500-500,000	5,000-1,500,000
Maximum Pressure	~4,500	~3,500	~3,000	~3,000
pH Range	2-7.5, 8.5-9.5 for short time	2-7.5, 8.5-9.5 for short time	2-7.5, 8.5-9.5 for short time	2-7.5, 8.5-9.5 for short time
Range of Salt Concentration	20 mM~2.0 M	20 mM~2.0 M	20 mM~2.0 M	20 mM~2.0 M
Highest Temperature(°C)	~80 °C	~80 °C	~80 °C	~80 °C
Mobile Phase	Aqueous or organic phase	Aqueous or organic phase	Aqueous or organic phase	Aqueous or organic phase

Sex Hormone in Cosmetics

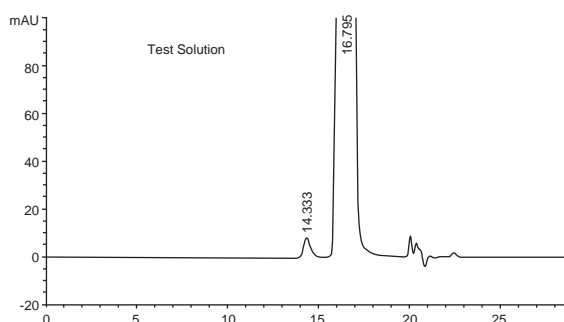

Column:	Xtimate [®] SEC-120, 3 µm, 300 x 7.8 mm
Mobile Phase:	HAC:ACN:0.1%Arginine=15:20:65
Flow Rate:	0.5 ml/min
Temperature:	35 °C
Detector:	276 nm
Injection Volume:	100 µl

Iron Dextran

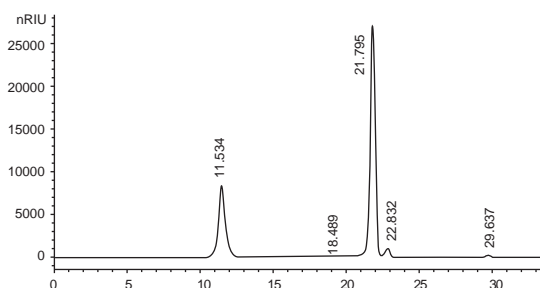

Column:	Xtimate [®] SEC-300, 5 µm, 300 x 7.8 mm
Mobile Phase:	Dissolve 7.1 g Na ₂ SO ₄ to 1000 ml water, filter
Flow Rate:	0.5 ml/min
Temperature:	Ambient
Detector:	RID
Injection Volume:	20 µl

Analysis of Molecular Weight of Polyethylene Glycol

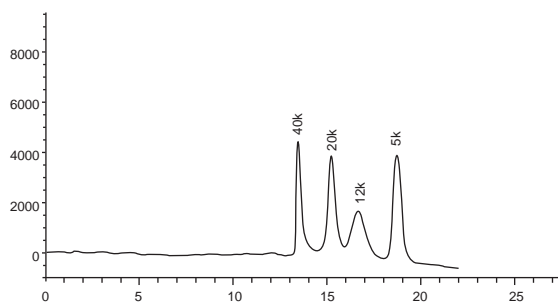

Column:	Xtimate® SEC-300, 5 µm, 300 x 7.8 mm
Mobile Phase:	Ultrapure Water
Flow Rate:	1.0 ml/min
Temperature:	40 °C, RID: 40 °C
Detector:	RID
Injection Volume:	20 µl

Cefoxitin Sodium

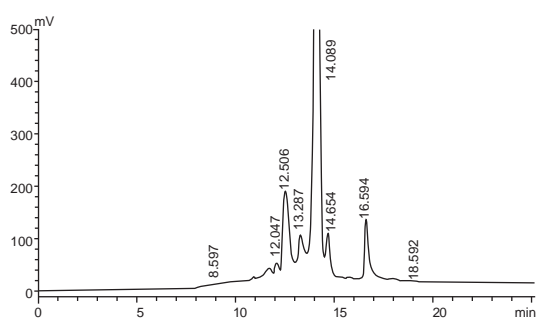

Column:	Xtimate® SEC-120, 5 µm, 300 x 7.8 mm
Mobile Phase:	Phosphate buffer:ACN=95:5
Flow Rate:	0.9 ml/min
Temperature:	30 °C
Detector:	232 nm
Injection Volume:	20 µl

Ordering Information

Dimension	SEC-120	SEC-300	SEC-700	SEC-1000
4.6×250	00237-31043	00237-33043	00237-34043	00237-35043
7.8×300	00237-31052	00237-33052	00237-34052	00237-35052

Xtimate® Polymer Based Column

Xtimate® Sugar-H is a special column designed for Ribavirin. Packed with H⁺ modified low-linking polystyrene-divinylbenzene spheres (PS-DVB), this column can be applied for the analysis of organic acids and mixed alcohols.

Xtimate® Sugar-Ca is a strong cation exchange column packed with Ca²⁺ modified PS-DVB resins; can be used for the analysis of sugar products.

Xtimate® PS/DVB is based on polystyrene-divinylbenzene. This column can be used in extreme conditions (pH 1-14).

Xtimate® G-10 glucan gel chromatographic column, which uses Sephadex G-10 glucan gel from GE Healthcare, is a special column developed for the analysis of ceftazidime, ceftriaxone sodium, cefoperazone sodium, cefotaxime sodium and any other Cephalosporins polymers.

Separation of Organic Acids

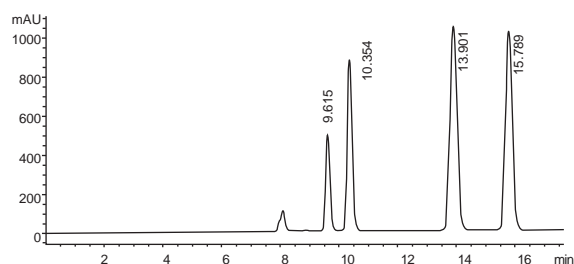

Column:	Xtimate® Sugar-H, 5 µm, 300 x 7.8 mm
Mobile Phase:	H ₂ SO ₄ water solution (pH 2.0)
Flow Rate:	0.5 ml/min
Temperature:	60 °C
Detector:	RID
Injection Volume:	20 µl
Organic Acids:	Maleic acid, L-malic acid, fumaric acid, sodium acetate trihydrate

Ketophenylalanine Calcium

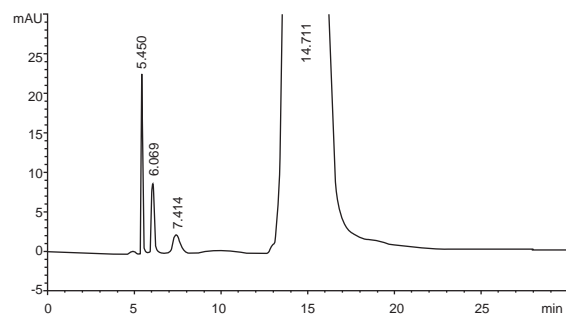

Column:	Xtimate® Sugar-H, 8 µm, 300 x 7.8 mm
Mobile Phase:	0.025 mol/l H ₂ SO ₄ water solution
Flow Rate:	0.8 ml/min
Temperature:	20 °C
Detector:	205 nm
Injection Volume:	20 µl

Xylose

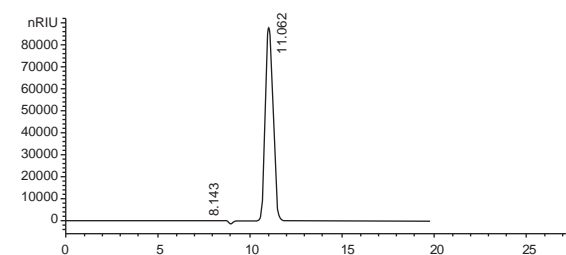

Column:	Xtimate® Sugar-Ca, 5 µm, 300 x 7.8 mm
Mobile Phase:	Ultra-pure water
Flow Rate:	0.6 ml/min
Temperature:	85 °C
Detector:	RID 55 °C
Injection Volume:	20 µl

Mannitol

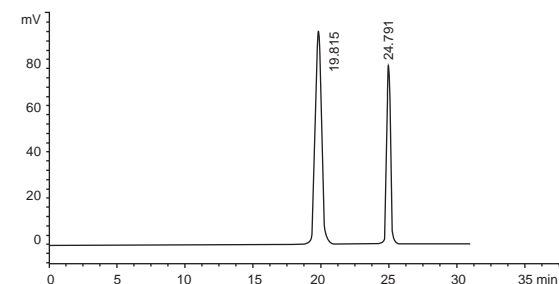

Column:	Xtimate® Sugar-Ca, 8 µm, 300 x 7.8 mm
Mobile Phase:	Ultra-pure water
Flow Rate:	0.5 ml/min
Temperature:	80 °C
Detector:	RID 55 °C
Injection Volume:	20 µl
System suitability test:	R of mannitol and Sorbitol >2

Doxycycline HCl

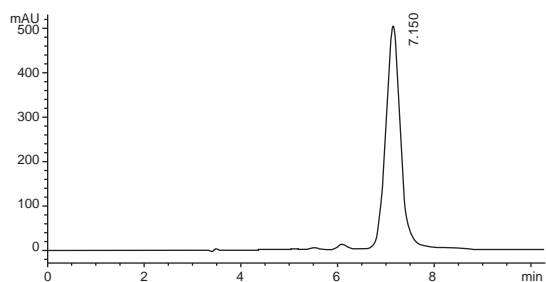
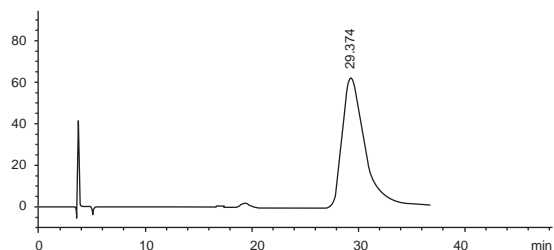

Column:	Xtimate® PS/DVB, 8 µm, 250 x 7.8 mm
Mobile Phase:	50 g TBA with 100 ml water, 200 ml buffer (pH 8.0), 25 ml TBAHS(10 g/l, pH 8.0, adjust with NaOH), 5 ml EDTA(40 g/l, pH 8.0, adjust with NaOH), dilute to 500 ml with water
Flow Rate:	2.0 ml/min
Temperature:	75 °C
Detector:	254 nm
Injection Volume:	20 µl
Notes:	Be sensitive to column temperature

Cefradine Polymer

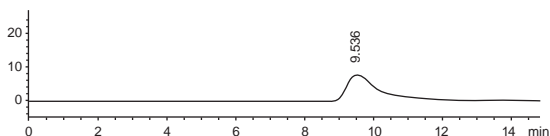
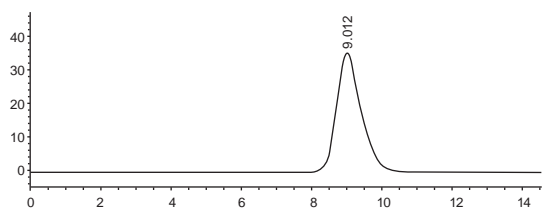

Column:	Xtimate® G-10, 300x15.0 mm
Mobile Phase:	A: 0.2M Na ₂ HPO ₄ :0.2M NaH ₂ PO ₄ =95:5 B: water
Flow Rate:	1.5 ml/min
Temperature:	30 °C
Detector:	254 nm
Injection Volume:	50 µl

Ordering Information:

	Sugar-H	Sugar-Ca
8 µm, 7.8x50 mm	00109-43048	00108-43048
8 µm, 7.8x100 mm	00109-43049	00108-43049
8 µm, 7.8x150 mm	00109-43050	00108-43050
8 µm, 7.8x250 mm	00109-43051	00108-43051
8 µm, 7.8x300 mm	00109-43052	00108-43052
8 µm, 4.6x250 mm	00109-43053	00108-43053
5 µm, 4.6x250 mm	00109-41043	00108-41043
5 µm, 4.6x300 mm	00109-41044	00108-41044
5 µm, 7.8x150 mm	00109-41050	00108-41050
5 µm, 7.8x250 mm	00109-41051	00108-41051
5 µm, 7.8x300 mm	00109-41052	00108-41052

Topsil[®] Series HPLC Column

Topsil[®] series HPLC column is a next-generation column by Welch, besides Ultisil[™], Xtimate[®] and Welchrom[®]. This series uses different silica and provides different selectivity.

Features:

- High purity silica (99.99%) with 150 Å pore size and 250 m²/g surface area
- 12% carbon loading for C18 phase
- Because of large pore and moderate carbon loading, Topsil[®] C18 phase can also be used as AQ-C18 without phase collapse
- Endcapped for excellent peak shape and lifetime
- Lower back pressure than Ultisil[™], almost the same column efficiency as Ultisil[™]
- Good for small molecules and peptides
- Topsil phases including C18, C8, Phenyl-Hexyl, Silica, NH₂ and CN

Compound Salvia Tablets

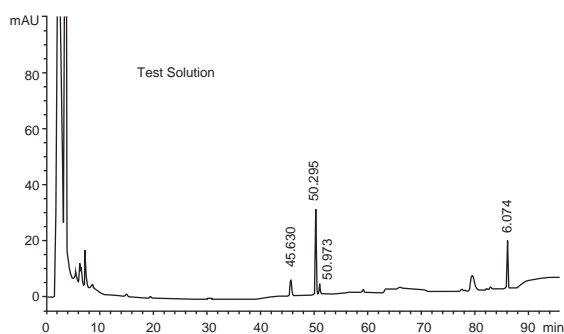

Column:	Topsil [®] C18, 250 x 4.6 mm, 5 μm		
Mobile Phase:	A: ACN B: Water		
Gradient Program:	Time(min)	A(%)	B(%)
	0	19	81
	35	19	81
	55	71	29
	70	71	29
100	40	60	
Flow Rate:	1.0 ml/min		
Temperature:	30 °C		
Detector:	203 nm		
Injection Volume:	20 μl		

Epigeal Srephaia Root

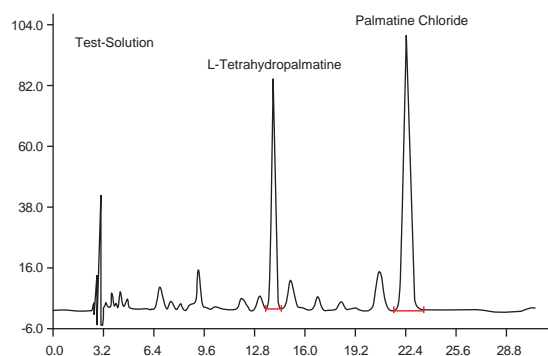

Column:	Topsil [®] C18, 250 x 4.6 mm, 5 μm
Mobile Phase:	25 mM NaAC buffer(2% trimethylamine, adjust pH to 3.50 with HAC)
Flow Rate:	1.5 ml/min
Temperature:	40 °C
Detector:	280 nm
Injection Volume:	20 μl

Ketoprofen

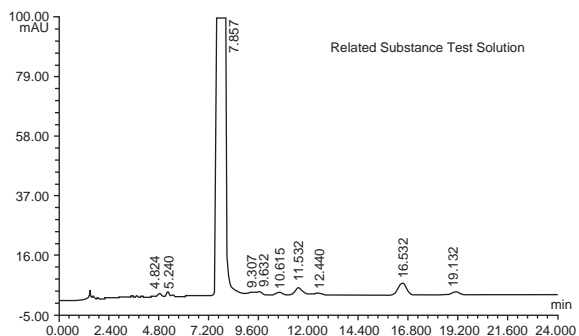

Column:	Topsil® C18, 150 x 4.6 mm, 5 µm
Mobile Phase:	Phosphate buffer (68 g KH ₂ PO ₄ dissolve in 1000 ml water, adjust pH to 3.5 with H ₃ PO ₄)
Flow Rate:	1.0 ml/min
Temperature:	30 °C
Detector:	233 nm
Injection Volume:	20 µl

Vitamin D3

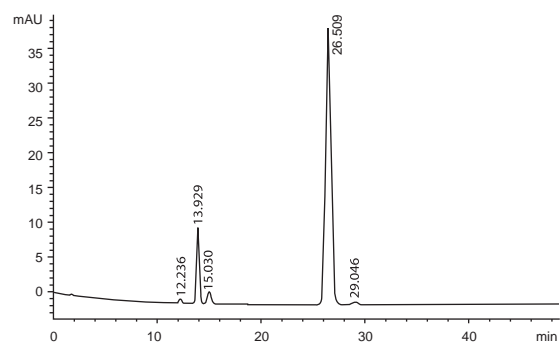

Column:	Topsil® Silica, 250 x 4.6 mm, 5 µm
Mobile Phase:	N-hexane:n-amyl alcohol=99.7:0.3
Flow Rate:	2.0 ml/min
Temperature:	30 °C
Detector:	254 nm
Injection Volume:	20 µl

Sex Hormone in Cosmetics

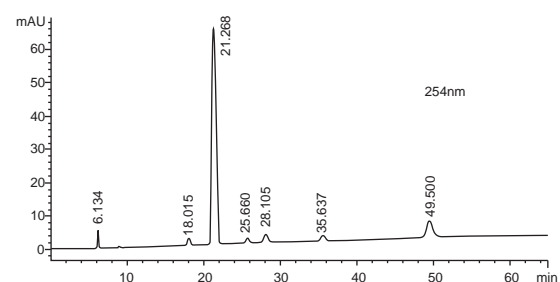

Column:	Topsil® Phenyl-Hexyl, 250 x 4.6 mm, 5 µm
Mobile Phase:	MeOH:H ₂ O=60:40
Flow Rate:	1.0 ml/min
Temperature:	30 °C
Detector:	210 nm, 254 nm
Injection Volume:	20 µl

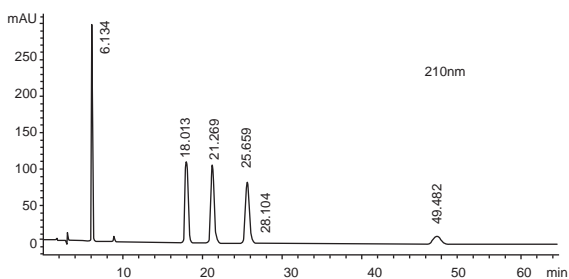

Mixed Standards:	Estrogen: estradiol, oestrone, estrotilben, estriol Androgen: testosterone, methyltestosterone Progestational hormone: progesterone
-------------------------	-------------------------------------------------------------------------------------------------------------------------------------------

Ordering Information

Dimension	Particle Size	C18	C8	NH ₂	CN	Silica	Phenyl-Hexyl
2.1×30 mm	5 μm	00410-01009	00420-01009	00430-01009	00440-01009	00450-01009	00460-01009
2.1×50 mm	5 μm	00410-01010	00420-01010	00430-01010	00440-01010	00450-01010	00460-01010
2.1×100 mm	5 μm	00410-01012	00420-01012	00430-01012	00440-01012	00450-01012	00460-01012
2.1×150 mm	5 μm	00410-01014	00420-01014	00430-01014	00440-01014	00450-01014	00460-01014
2.1×200 mm	5 μm	00410-01015	00420-01015	00430-01015	00440-01015	00450-01015	00460-01015
2.1×250 mm	5 μm	00410-01016	00420-01016	00430-01016	00440-01016	00450-01016	00460-01016
3.0×30 mm	5 μm	00410-01018	00420-01018	00430-01018	00440-01018	00450-01018	00460-01018
3.0×50 mm	5 μm	00410-01019	00420-01019	00430-01019	00440-01019	00450-01019	00460-01019
3.0×100 mm	5 μm	00410-01021	00420-01021	00430-01021	00440-01021	00450-01021	00460-01021
3.0×150 mm	5 μm	00410-01023	00420-01023	00430-01023	00440-01023	00450-01023	00460-01023
3.0×200 mm	5 μm	00410-01024	00420-01024	00430-01024	00440-01024	00450-01024	00460-01024
3.0×250 mm	5 μm	00410-01025	00420-01025	00430-01025	00440-01025	00450-01025	00460-01025
3.0×300 mm	5 μm	00410-01026	00420-01026	00430-01026	00440-01026	00450-01026	00460-01026
4.0×30 mm	5 μm	00410-01027	00420-01027	00430-01027	00440-01027	00450-01027	00460-01027
4.0×50 mm	5 μm	00410-01028	00420-01028	00430-01028	00440-01028	00450-01028	00460-01028
4.0×100 mm	5 μm	00410-01030	00420-01030	00430-01030	00440-01030	00450-01030	00460-01030
4.0×150 mm	5 μm	00410-01032	00420-01032	00430-01032	00440-01032	00450-01032	00460-01032
4.0×200 mm	5 μm	00410-01033	00420-01033	00430-01033	00440-01033	00450-01033	00460-01033
4.0×250 mm	5 μm	00410-01034	00420-01034	00430-01034	00440-01034	00450-01034	00460-01034
4.0×300 mm	5 μm	00410-01035	00420-01035	00430-01035	00440-01035	00450-01035	00460-01035
4.6×30 mm	5 μm	00410-01036	00420-01036	00430-01036	00440-01036	00450-01036	00460-01036
4.6×50 mm	5 μm	00410-01037	00420-01037	00430-01037	00440-01037	00450-01037	00460-01037
4.6×100 mm	5 μm	00410-01039	00420-01039	00430-01039	00440-01039	00450-01039	00460-01039
4.6×150 mm	5 μm	00410-01041	00420-01041	00430-01041	00440-01041	00450-01041	00460-01041
4.6×200 mm	5 μm	00410-01042	00420-01042	00430-01042	00440-01042	00450-01042	00460-01042
4.6×250 mm	5 μm	00410-01043	00420-01043	00430-01043	00440-01043	00450-01043	00460-01043
4.6×300 mm	5 μm	00410-01044	00420-01044	00430-01044	00440-01044	00450-01044	00460-01044

Welchrom® Series HPLC Column

--- Combination of perfect peak shape and lowest back pressure

- Perfect peak shape and low back pressure
- Ultra-high purity(>99.999%) Type B silica particles
- New bonding and endcapping technique
- Economically priced

Comparison with Other Brands

Brands	Tailing factor(amitriptyline)	Back pressure(Methanol/H ₂ O)=75/25
Welchrom® C18	1.29	77 bar
Chrom C18	1.52	108 bar
Sino Chrom C18	1.71	106 bar
BinChrom C18	1.67	102 bar

Tanshinone IIA in Salvia Miltiorrhiza

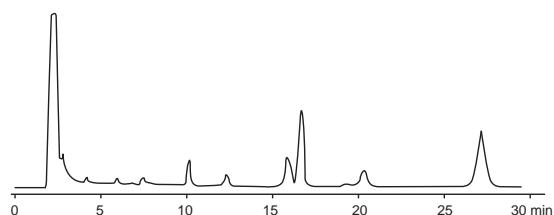

Column:	Welchrom® C18, 250 x 4.6 mm, 5 µm
Mobile Phase:	MeOH:H ₂ O=75:25
Flow Rate:	1.0 ml/min
Temperature:	22 °C
Detector:	270 nm

Imidacloprid

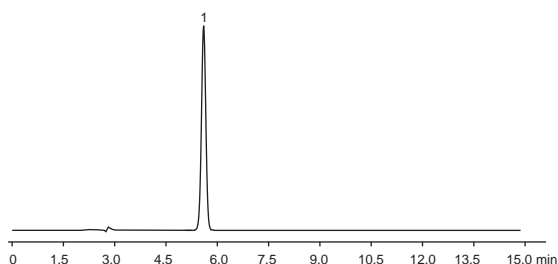

Column:	Welchrom® C18, 250 x 4.6 mm, 5 µm
Mobile Phase:	MeOH:H ₂ O=45:55
Flow Rate:	1.0 ml/min
Temperature:	25 °C
Detector:	260 nm

Ordering Information

Dimension	Welchrom® C18	Welchrom® C8
4.6×150 mm, 5 µm	00310-02041	00320-02041
4.6×200 mm, 5 µm	00310-02042	00320-02042
4.6×250 mm, 5 µm	00310-02043	00320-02043

Preparative HPLC Column

How to Choose a Preparative Column?

Step1: select the column packing

Welch provides all types of packing materials, the detail of which is shown in the packing materials part

Choose pore size according to molecular weight						
Molecular Weight	< 800	< 2000	< 10,000	< 50,000	< 250,000	≥ 300,000
Pore Size	60 Å	120 Å	200 Å	300 Å	1000 Å	≥ 1000 Å

Choose proper particle size according to stress tolerance						
Pressure	90 bar	40 bar	20 bar	6 bar	4 bar	1 bar
Particle Size	5 μm	10 μm	15 μm	20-40 μm	40-70 μm	≥ 200 μm

Step2: select particle size, pore size to achieve good recovery according to the sample properties

C18, C8, C4 are the most universal bonding phases to separate proteins, peptides.

Bonding Phase		Pore Size	Retention time			Plate number			Column pressure			Molecular Weight
			C18	C8	C4	C18	C8	C4	C18	C8	C4	
High	High	120 Å	◆	⇒	◇	⇒	◇	⇒	◇	⇒	◇	≤ 5000
Plate Number	Column Pressure	200 Å	◇	⇐	◆	⇒	◇	⇒	◇	⇒	◇	5000-20,000
Low	Low	300 Å	◇	⇐	◇	⇐	◆	⇐	◆	⇐	◆	20,000-100,000

◆ Most appropriate ◇ Appropriate.

Step 3: choose preparative columns based on mass loading and sample property

Mass Loading	Particle		5	10	10/20	15/30	50
	Size μm	Diameter mm	N=90,000	N=40,000	N=20,000	N=10,000	N=5,000
Test	4.6		▲	▲	▲	▲	▲
10-50mg	10		★	◆	▲	▲	▲
	20		★	★	▲	▲	▲
50-100mg	30		◆	★	◆	▲	▲
0.1-1g	50		▲	★	★	▲	▲
	100			▲	★	◆	▲
1-10g	150			▲	★	◆	▲
	200					◆	★
10-100g	200					◆	★
≥ 100g	≥ 300					▲	★

Changes of column efficiency, column pressure and cost	Column Efficiency			Column pressure		
	High	← Cost →	Low	High	← Cost →	Low

★: Most appropriate ◆: Appropriate ▲: According to the purpose

Step 4: determine flow rate, mass loading, start experiment

$$\text{Scale-up factor} = \frac{(\text{Diameter prep})^2}{(\text{Diameter anal})^2} \times \frac{\text{Length prep}}{\text{Length analytical}}$$

Consider scaling up from a 4.6×250 mm column to a 10×250 mm column:

$$\text{Scale-up factor} = \frac{(10)^2}{(4.6)^2} \times \frac{250}{250} = 4.73$$

$$\text{Flow rate(perp)} = \text{Flow rate(anal)} \times \frac{(\text{Diameter prep})^2}{(\text{Diameter anal})^2}$$

Consider 4.6 mm analytical column where flow rate = 1 ml/min. On 10 mm prep column, the flow rate = $1 \times \frac{(10)^2}{(4.6)^2} \approx 4.7 \text{ ml/min}$

This calculated flow rate may be used for the larger column to ensure the same linear velocity of mobile phases as used in the analytical run. However, reasonable flow rates are based on column diameters. Systems will be limited by increasing backpressure with increasing column length and decreasing particle size.

Mass loading

Approximate Mass Loading Capacity

Items	Diameter				
	4.6×250 mm	10×250 mm	21.2×250 mm	30×250 mm	50×250 mm
Packing Amount(g)	3	13	60	110	350
Scale-up Factor	1	4.73	21.2	42.5	118
Mass Loading(mg)	0.03-3	0.15-13	0.6-60	1.1-110	3-350
Flow Rate Range(ml/min)	0.5-2	3-9	14-40	28-85	80-250

Preparative Column

Preparative Column uses the same packing materials as does analytical column, to ensure the best reproducibility of analysis and preparative scale. Special packing technique and stainless modular column tube ensure the stability of column bed. The theoretical plate number for 10 μm column is greater than 35000/m; for 5 μm column, it is greater than 75000/m, and the peak symmetry is around 0.95~1.20.

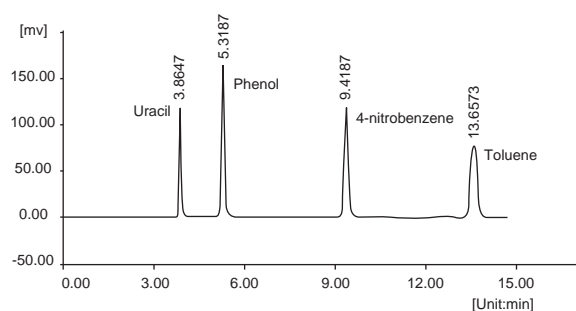
Better Column Efficiency and Tailing

Column	Ultisil™ XB-C18, 250 x 10 mm, 5 μm
Mobile Phase	75% MeOH
Flow Rate	3.0 ml/min
Detector	254 nm

Samples	Retention time(min)	Half Peak Width(min)	Theoretical Plate Number	R	Tailing Factor
Uracil	3.8647	0.0713	16261	0.00	1.18
Phenol	5.3187	0.0933	17990	10.40	1.19
4-nitrobenzene chloride	9.4197	0.1537	20817	19.55	1.11
Methylbenzene	13.6573	0.2210	21157	13.32	1.07

Better Separation Efficiency, Easier for Linear Amplification

Generally, research is done on the analytical column at first. Then the same packing materials is used, to ensure the stability during linear amplification.

Perfect Separation with Different Dimensions

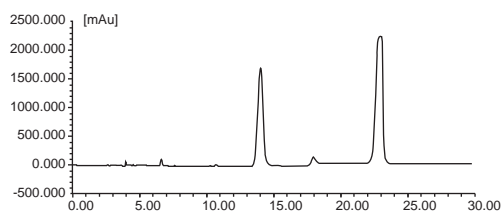

Column	Ultisil™ XB-C18, 250 x 10 mm, 5 μm
Flow Rate	1.0 ml/min
Sample Loading	0.5 mg

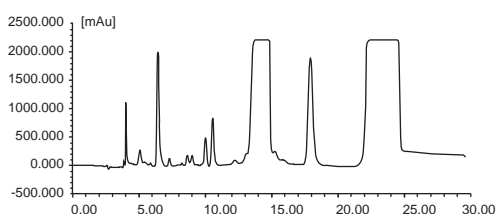

Column	Ultisil™ XB-C18, 250 x 20 mm, 5 μm
Flow Rate	20 ml/min
Sample Loading	100 mg

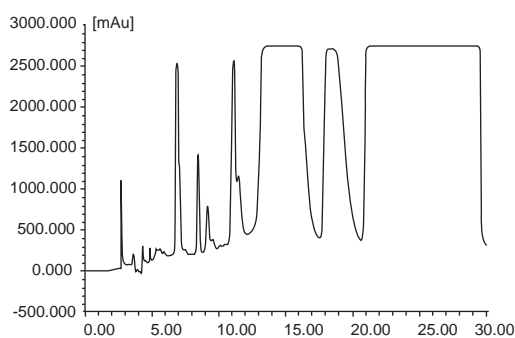

Column	Ultisil™ XB-C18, 250 x 50 mm, 5 μm
Flow Rate	118 ml/min
Sample Loading	2000 mg

Ultisil™ 5 μm Preparative Column Ordering Information

Ultisil™ series also provides 10 μm packing materials.

Phases	XB-C18	XB-C8	XB-C30	AQ-C18	XB-Phenyl	Polar RP	LP-C18
10x100 mm	02610-21100	02620-21100	02628-21100	02612-21100	02640-21100	02621-21100	02613-21100
10x150 mm	02610-21101	02620-21101	02628-21101	02612-21101	02640-21101	02621-21101	02613-21101
10x250 mm	02610-21102	02620-21102	02628-21102	02612-21102	02640-21102	02621-21102	02613-21102
20x50 mm	02610-21130	02620-21130	02628-21130	02612-21130	02640-21130	02621-21130	02613-21130
20x150 mm	02610-21132	02620-21132	02628-21132	02612-21132	02640-21132	02621-21132	02613-21132
20x250 mm	02610-21134	02620-21134	02628-21134	02612-21134	02640-21134	02621-21134	02613-21134
30x150 mm	02610-21107	02620-21107	02628-21107	02612-21107	02640-21107	02621-21107	02613-21107
30x250 mm	02610-21108	02620-21108	02628-21108	02612-21108	02640-21108	02621-21108	02613-21108
50x150 mm	02610-21209	02620-21209	02628-21209	02612-21209	02640-21209	02621-21209	02613-21209
50x250 mm	02610-21210	02620-21210	02628-21210	02612-21210	02640-21210	02621-21210	02613-21210

Phases	SiO ₂	XB-Diol	XB-SAX	XB-SCX	LP-C8	XB-NH ₂	XB-CN
10x100 mm	02600-21100	02611-21100	02690-21100	02614-21100	02625-21100	02630-21100	02650-21100
10x150 mm	02600-21101	02611-21101	02690-21101	02614-21101	02625-21101	02630-21101	02650-21101
10x250 mm	02600-21102	02611-21102	02690-21102	02614-21102	02625-21102	02630-21102	02650-21102
20x50 mm	02600-21130	02611-21130	02690-21130	02614-21130	02625-21130	02630-21130	02650-21130
20x150 mm	02600-21132	02611-21132	02690-21132	02614-21132	02625-21132	02630-21132	02650-21132
20x250 mm	02600-21134	02611-21134	02690-21134	02614-21134	02625-21134	02630-21134	02650-21134
30x150 mm	02600-21107	02611-21107	02690-21107	02614-21107	02625-21107	02630-21107	02650-21107
30x250 mm	02600-21108	02611-21108	02690-21108	02614-21108	02625-21108	02630-21108	02650-21108
50x150 mm	02600-21209	02611-21209	02690-21209	02614-21209	02625-21209	02630-21209	02650-21209
50x250 mm	02600-21210	02611-21210	02690-21210	02614-21210	02625-21210	02630-21210	02650-21210

Xtimate® Preparative Column Ordering Information

Dimension	Particle Size	C18	C8	NH ₂	Phenyl-Hexyl	CN	Polar RP	SEC-120
10x250 mm	5 µm	01610-21102	01620-21102	01630-21102	01670-21102	01650-21102	01621-21102	01631-21102
20x150 mm	5 µm	01610-21132	01620-21132	01630-21132	01670-21132	01650-21132	01621-21132	01631-21132
20x250 mm	5 µm	01610-21134	01620-21134	01630-21134	01670-21134	01650-21134	01621-21134	01631-21134
30x150 mm	5 µm	01610-21107	01620-21107	01630-21107	01670-21107	01650-21107	01621-21107	01631-21107
30x250 mm	5 µm	01610-21108	01620-21108	01630-21108	01670-21108	01650-21108	01621-21108	01631-21108
50x150 mm	5 µm	01610-21109	01620-21109	01630-21109	01670-21109	01650-21109	01621-21109	01631-21109
50x250 mm	5 µm	01610-21110	01620-21110	01630-21110	01670-21110	01650-21110	01621-21110	01631-21110
10x250 mm	10 µm	01610-31102	01620-31102	01630-31102	01670-31102	01650-31102	01621-31102	01631-31102
20x150 mm	10 µm	01610-31132	01620-31132	01630-31132	01670-31132	01650-31132	01621-31132	01631-31132
20x250 mm	10 µm	01610-31134	01620-31134	01630-31134	01670-31134	01650-31134	01621-31134	01631-31134
30x150 mm	10 µm	01610-31107	01620-31107	01630-31107	01670-31107	01650-31107	01621-31107	01631-31107
30x250 mm	10 µm	01610-31108	01620-31108	01630-31108	01670-31108	01650-31108	01621-31108	01631-31108
50x150 mm	10 µm	01610-31209	01620-31209	01630-31209	01670-31209	01650-31209	01621-31209	01631-31209

Flash Column—Low Pressure Preparative Column

Flash column chromatography is a quick and (usually) easy way to separate complex mixtures of compounds. It is widely applied to organic compounds, natural products, biomacromolecule and any other active substances.

Features of WelFlash

- Homogeneous particle and pore size, special bonding technique from Welch
- Perfect result reproducibility, best performance
- All types of packing materials and specifications
- Polypropylene tube and joint to tolerate the column pressure of fast chromatography
- Provide abundant applications
- Easy operation, low cost, fast separation and low back pressure

Packing Materials of WelFlash

		Particle Size (µm)	Pore Size (Å)	Surface Area (m ² /g)	Description
Amorphous spherical silica	WelFlash™ SiO ₂ -II	-	60	-	Normal phase; separates weak polar compound while using weak polar mobile phase.
	WelFlash™ C18-II	-	60	-	Reversed phase; the most universal packing material.
Spherical silica	WelFlash™ SiO ₂	20-40 40-70	120	480	Considered the most polar normal phase sorbent available, Highly polar sorbent to retain polar compounds from nonpolar matrices.
	WelFlash™ C18	20-40 40-70	120	480	The most popular C18 sorbent.
	WelFlash™ Phenyl	20-40 40-70	120	480	Similar polarity to C8; Additional polar secondary π-π interactions enhance retention of aromatic compounds.
	WelFlash™ CN	20-40 40-70	120	480	Separate polar or non-polar compounds.
	WelFlash™ NH ₂	20-40 40-70	120	480	Can be used for compounds containing -OH, -NH or -SH group by hydrogen bonding.
	WelFlash™ Hilic	20-40 40-70	120	480	Polar/Hydrophilic compounds have sufficient retention in HILIC; can be an interesting alternative to RPLC for some types of compounds.
	WelFlash™ SAX	20-40 40-70	120	480	Retains negatively charged compounds.
	WelFlash™ SCX	20-40 40-70	120	480	Useful for compounds with cationic and basic characteristics.
Inorganic absorption (aluminium oxide)	WelFlash™ Alumina-N	-	-	-	Neutral polar alumina sorbent (pH 6.5) widely used in the sample separation of aldehydes, ketones, quinones, and some glycosides.
	WelFlash™ Alumina-B	-	-	-	Basic alumina sorbent (pH 8.5). Ideal for the separation of hydrocarbons, removal of oxy-compounds from hydrocarbons.
	WelFlash™ Alumina-A	-	-	-	Slightly acidic alumina sorbent (pH 4.5). Ideal for the separation of natural and synthetic acidic pigments, acids, and aldehydes.

Excellent Packing Technique

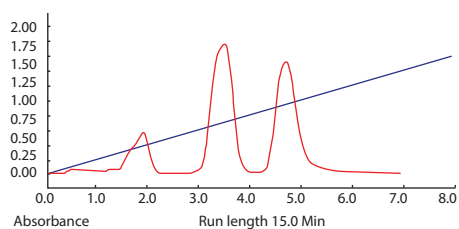

Fig.A: WelFlash Column(12 g)

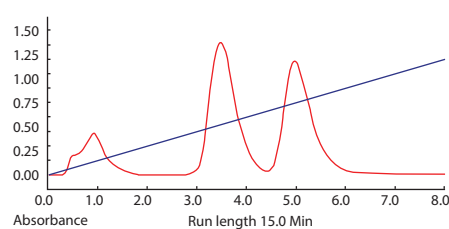
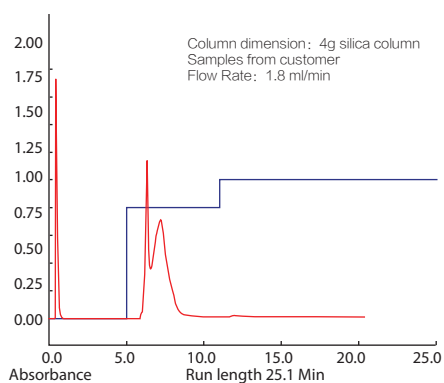

Fig.B: Flash Column(12 g) of company S

Comparing WelFlash™ Column with S company's flash column at the same chromatographic conditions, one can find that WelFlash achieves baseline separation in shorter time.

Optimize Method to Achieve Faster Separation



Before Method Optimization

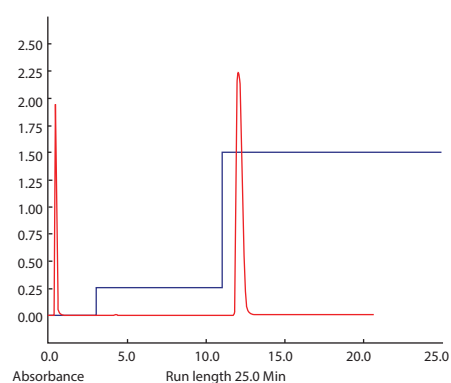

After Method Optimization

After method optimization, one can achieve increased adsorption and elution capacity, better peak shape, and smaller half width of main peaks, and therefore save time in sample data collection.

WelFlash Dimensions

The easiest way to shorten separation time is to use short column and high flow rate. But since short column length leads to decreased column efficiency, we recommend column length between 10-75 mm, which is the best proportion after optimization to ensure largest sample loading and best separation efficiency.

WelFlash dimension: 4 g, 12 g, 25 g, 40 g, 80 g, 120 g, 220 g and 330 g.

WelFlash Column Compatibility

- 1) Luer-lok™ import and Luer™ export, good compatibility with most systems, such as Isco®, Biotage®, and Armen®
- 2) PP column tube and adapter; can tolerate the pressure of regular systems.

Strict Products Quality Testing Process

1) Pressure Tolerance

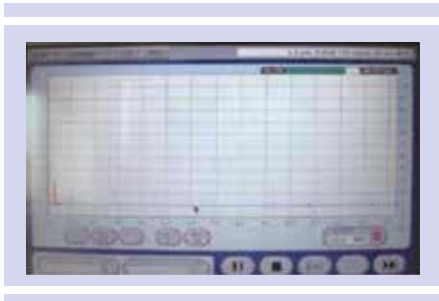

2) Performance Test (good peak shape and separation performance)

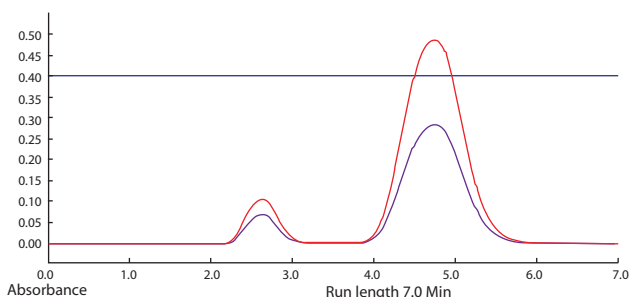

Applications

Comparison of Spherical Silica and Amorphous Spherical Silica

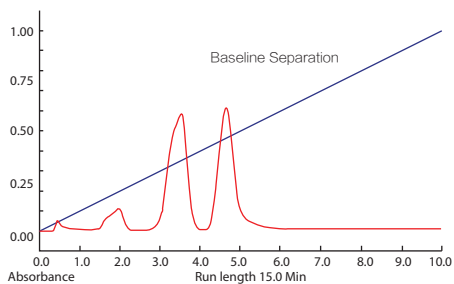
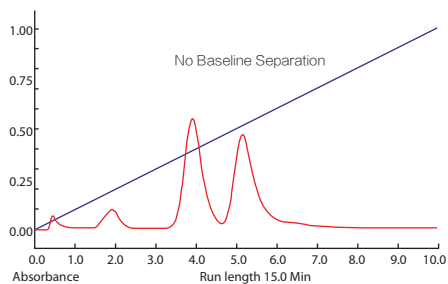

Fig. 1 WelFlash Column: 4 g Spherical Silica (20-40 μm)



WelFlash Column: 4 g Amorphous Silica (40-63 μm)

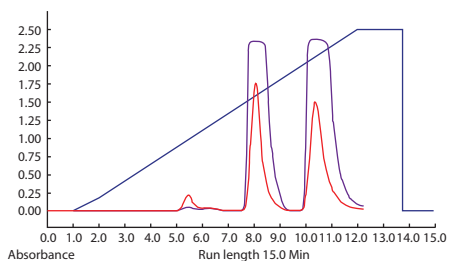
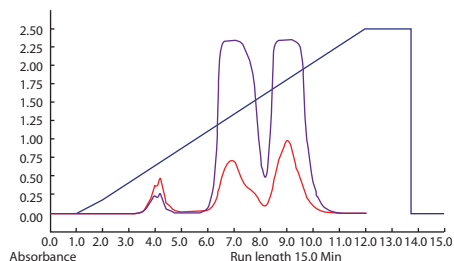
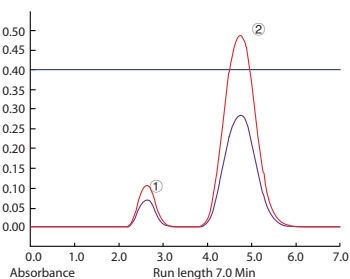

Fig. 2 WelFlash Column: 40 g Spherical Silica (20-40 μm)



WelFlash Column: 40 g Amorphous Silica (40-63 μm)

Under same conditions, 4 g Spherical WelFlash column can get baseline separation in a short time, but amorphous WelFlash cannot. When compared to 40 g amorphous silica column, 40 g spherical WelFlash column shows better performance.



1. Acetophenone 2. Methoxyacetophenone

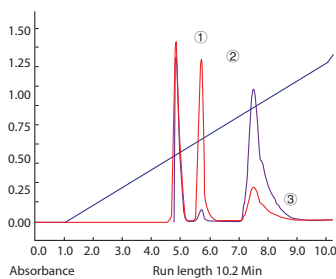

1. Acetophenone 2. Methoxyacetophenone
3. 3,4-aminobenzoic acid

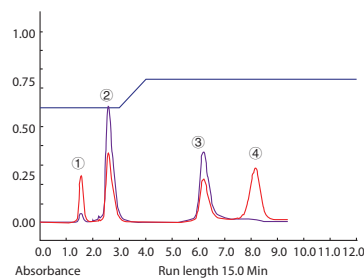

1. Acetophenone 2. Methoxyacetophenone
3. 3,4-aminobenzoic acid 4. 3,4-aminobenzoic acid

Ordering Information

Amorphous spherical silica based packing materials

WelFlash™	4 g, 20 pk	12 g, 18 pk	25 g, 12 pk	40 g, 10 pk	80 g, 10 pk	120 g, 10 pk	220 g, 6 pk	330 g, 4 pk
SiO ₂ -II	00001-05011	00001-05021	00001-05031	00001-05042	00001-05053	00001-05063	00001-05075	00001-05084
C18-II	00002-05011	00002-05021	00002-05031	00002-05042	00002-05053	00002-05063	00002-05075	00002-05084

Spherical silica based packing materials

20-40 µm								
WelFlash™	4 g, 20 pk	12 g, 18 pk	25 g, 12 pk	40 g, 10 pk	80 g, 10 pk	120 g, 10 pk	220 g, 6 pk	330 g, 4 pk
SiO ₂	00001-03011	00001-03021	00001-03031	00001-03042	00001-03053	00001-03063	00001-03075	00001-03084
C18	00002-03011	00002-03021	00002-03031	00002-03042	00002-03053	00002-03063	00002-03075	00002-03084
Phenyl	00003-03011	00003-03021	00003-03031	00003-03042	00003-03053	00003-030633	00003-03075	00003-03084
CN	00004-03011	00004-03021	00004-03031	00004-03042	00004-03053	00004-03063	00004-03075	00004-03084
Diol	00014-03011	00014-03021	00014-03031	00014-03042	00014-03053	00014-03063	00014-03075	00014-03084
40-70 µm								
WelFlash™	4 g, 20 pk	12 g, 18 pk	25 g, 12 pk	40 g, 10 pk	80 g, 10 pk	120 g, 10 pk	220 g, 6 pk	330 g, 4 pk
SiO ₂	00001-04011	00001-04021	00001-04031	00001-04042	00001-04053	00001-04063	00001-04075	00001-04084
C18	00002-04011	00002-04021	00002-04031	00002-04042	00002-04053	00002-04063	00002-04075	00002-04084

Inorganic absorption packing materials (aluminium oxide)

WelFlash™	8 g, 20 pk	24 g, 18 pk	50 g, 12 pk	80 g, 10 pk	160 g, 10 pk	240 g, 10 pk	440 g, 6 pk	660 g, 4 pk
Alumina-N	00011-00011	00011-00021	00011-00031	00011-00042	00011-00053	00011-00063	00011-00075	00011-00084
Alumina-B	00010-00011	00010-00021	00010-00031	00010-00042	00010-00053	00010-00063	00010-00075	00010-00084
Alumina-A	00009-00011	00009-00021	00009-00031	00009-00042	00009-00053	00009-00063	00009-00075	00009-00084

Guard Column and Pre-Column

Column Protection

- Guard and filters to protect your analytical column
- Economical extension of column life time

Guard column	Pre-column
<ul style="list-style-type: none"> • Between injector and analytical column • All have column holders • All have frit to retain solid particles 	
Packing materials inside a Guard Column cartridge	Filter inside a Pre-column
Remove strongly adsorbed sample components	Trap particulate matter from the fluid path, but does not remove sample components or contaminants
Internal diameters should match as closely as possible and packing material should be of the same particle size and chemistry as the analytical column	<ul style="list-style-type: none"> i) Can be used with other brands of columns ii) Designed to be wholly disposable or has replaceable filters in a re-useable holder

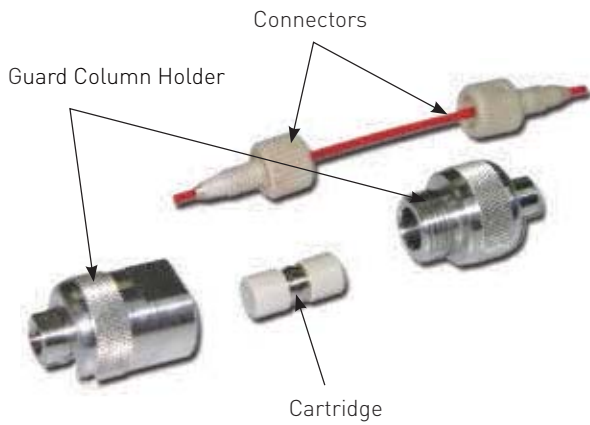

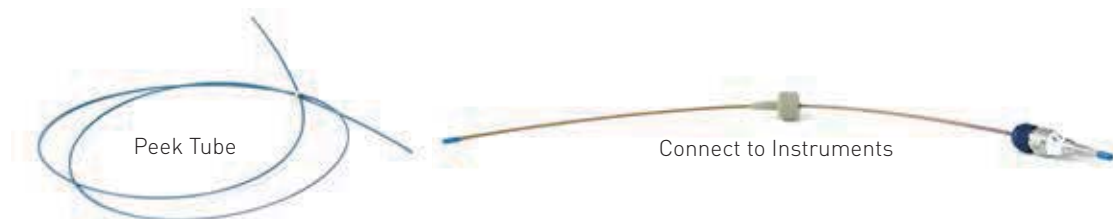

Ordering Information

Ultisil™ Guard Cartridges

Phases	5 µm particle			10 µm particle		
	4.6×10 mm	10×10 mm	21.2×10 mm	4.6×10 mm	10×10 mm	21.2×10 mm
XB-C18	00808-04001	00808-04401	00808-04801	00808-05001	00808-05401	00808-05801
AQ-C18	00808-04003	00808-04403	00808-04803	00808-05003	00808-05403	00808-05803
XB-C8	00808-04002	00808-04402	00808-04802	00808-05002	00808-05402	00808-05802
XB-NH ₂	00808-04004	00808-04404	00808-04804	00808-05004	00808-05404	00808-05804
XB-CN	00808-04005	00808-04405	00808-04805	00808-05005	00808-05405	00808-05805
XB-Phenyl	00808-04006	00808-04406	00808-04806	00808-05006	00808-05406	00808-05806

Xtimate™ Guard Cartridges

Phases	5 µm particle			10 µm particle		
	4.6×10 mm	10×10 mm	21.2×10 mm	4.6×10 mm	10×10 mm	21.2×10 mm
C18	00808-04101	00808-04501	00808-04901	00808-05101	00808-05501	00808-05901
C8	00808-04102	00808-04502	00808-04902	00808-05102	00808-05502	00808-05902
C4	00808-04103	00808-04503	00808-04903	00808-05103	00808-05503	00808-05903
NH ₂	00808-04104	00808-04504	00808-04904	00808-05104	00808-05504	00808-05904
CN	00808-04105	00808-04505	00808-04905	00808-05105	00808-05505	00808-05905
Phenyl	00808-04106	00808-04506	00808-04906	00808-05106	00808-05506	00808-05906

Guard Column Holder

2.1 mm ID (Minibore Column)	00808-01107
4.6 mm ID (Analytical Column)	00808-01101
10 mm ID (Semi Prep Column)	00808-01103
21.2 mm ID (Prep Column)	00808-01105

Pre-column Holder

4.6 mm ID (Analytical Column)	00808-01201
21.2 mm ID (Prep Column)	00808-01204

Pre-column Filter

0.2 µm frit (Analytical Column)	00808-01202
2 µm frit (Analytical Column)	00808-01203
2 µm frit (Prep Column)	00808-01205

Connection Parts for Guard Column (Peek Tube)	00808-01301
Connection Parts for Pre-column	00808-01302

GC Column

WM Series High Performance GC Column WEL Series Economical GC Column (Contact Welch for this serie)

WM high-performance	Composition of Stationary Phase	Polarity	Temperature Limit	Characteristics and Applications
WM-1, WM-1 MS	100% Dimethyl Polysiloxane	Nonpolarity	-60 to 325/350	Hydrocarbons, Aromatics, Pesticides, Phenols, Herbicides, Amines, Fatty Acid Methyl Esters, etc.
WM-5, WM-5MS	5% Phenyl, 95% Dimethyl Polysiloxane	Weak polarity	-60 to 325/350	Hydrocarbons, Aromatics, Pesticides, Herbicides, Drugs, etc.
WM-1301	6% Cyanopropyl-phenyl 94% Dimethyl Polysiloxane	Moderate polarity	-20 to 280/300	Alcohols, Pesticides, VOCs, iodines, Pesticide Residues, etc.
WM-624	6% Cyanopropyl 94% Dimethyl Polysiloxane	Moderate polarity	-20 to 280/300	VOCs, Solvent Impurities, etc.
WM-35, WM-35MS	35% phenyl, 65% Dimethyl Polysiloxane	Moderate polarity	40 to 320/340	Alcohols, Pesticides, Drugs
WM-1701	14% Cyanopropyl-phenyl 86% Dimethyl Polysiloxane	Moderate polarity	-20 to 280/300	Pesticides, Herbicides, Drugs, Environmental Samples, etc.
WM-17	50% Phenyl 50% Dimethyl Polysiloxane	Moderate polarity	0 to 300/320	Pesticides, Herbicides, Drugs, Environmental Samples, etc.
WM-InoWax	PEG-20M	Strong polarity	40 to 260/280	Alcohols, Free Acids, Fatty Acid Methyl Esters, Polynuclears, Aromatics, Solvents, Essential Oils etc.
WM-FFAP	Reaction products of PEG-20M and TPA	Strong polarity	40 to 260	Alcohols, Free Acids, Fatty Acid Methyl Esters, Aldehydes, Acrylic Esters, Ketones, etc.

Welch GC Columns by USP listing

WEL	USP	Similar Stationary Phase
WM-1	G2	DB-1, HP-1, OV-1, Rtx-1, SBP-1, CP-Sil 5CB
WM-1 MS	G2	DB-1 MS, HP-1 MS, ZB-1 MS, OV-1 MS
WM-5	G27	BP-5, ZB-5, CP-Sil 8CB, DB-5, HP-5, SPB-5, Rtx-5, OV-5
WM-5MS	G27	ZB-5MS, DB-5MS, HP-5MS, OV-5 MS
WM-20	-	Rtx-20, SPB-20, VOCOL
WM-1301	G43	DB-1301, HP-1301, PE-1301, Rtx-1301
WM-624	G46	007-624, AT-624, CP-624, DB-624, HP-624, Rtx-502.2, VOCOL
WM-225	G7	007-225, DB-225, BP-225, HP-225, CP-Sil 43CB, Rtx-Wax
WM-35	G42	DB-35, HP-35, SPB-35, Rtx-35, PE-35, AT-35
WM-1701	G46	BP-10, CB-1701, CP-Sil 19CB, DB-1701, Rtx-1701
WM-17	G3	DB-17, HP-17, HP-50, Rtx-50, AT-50, ZB-50, SPB-50, CP-Sil 24, SP-2250
WM-InoWax	G16	CP-Wax, DB-Wax, HP-Innowax, PE-Wax, Rtx-Wax
WM-FFAP	G35	BP-21, HP-FFAP, PE-FFAP, CP-FFAP, DB-FFAP, Nukol

Phthalate Esters

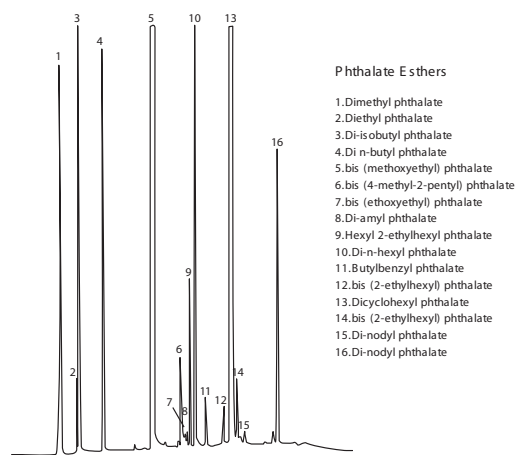

Column

WM-5, 30×0.25 mm, 0.5 µm; P/N: 03902-22002

Temperature

100 °C $\xrightarrow{10\text{ °C/min}}$ 250 °C (maintain 10 min)

Injection port temperature

250 °C

Detector temperature

300 °C

Detector

F.I.D.

Polynuclear Aromatic Hydrocarbons

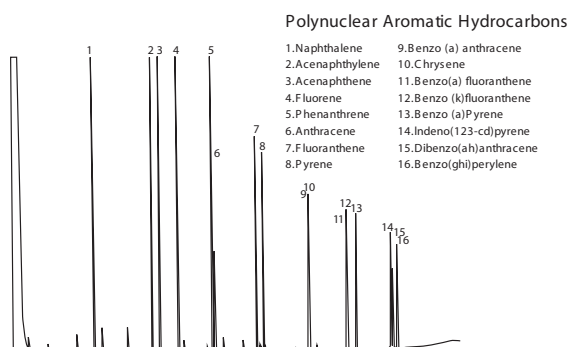

Column

WM-5, 30×0.32 mm, 0.25 µm; P/N: 03902-32001

Temperature

70 °C (maintain 4 min) $\xrightarrow{10\text{ °C/min}}$ 250 °C (maintain 10 min)

Injection port temperature

250 °C

Detector temperature

300 °C

Detector

F.I.D.

Fame

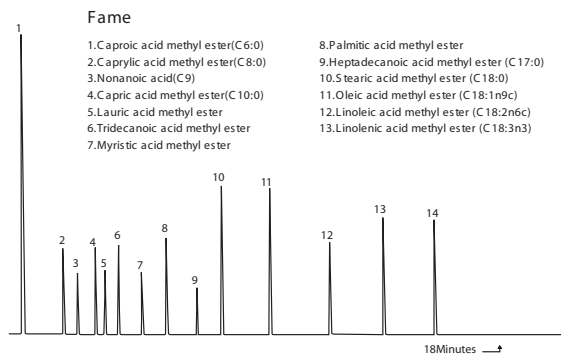

Column

WM-INOWAX, 30×0.32 mm, 0.25 µm; P/N: 03909-32001

Temperature

80 °C (maintain 4 min) $\xrightarrow{10\text{ °C/min}}$ 200 °C (maintain 10 min)

Injection port temperature

200 °C

Detector temperature

250 °C

Detector

F.I.D.

Organicchloride Pesticides

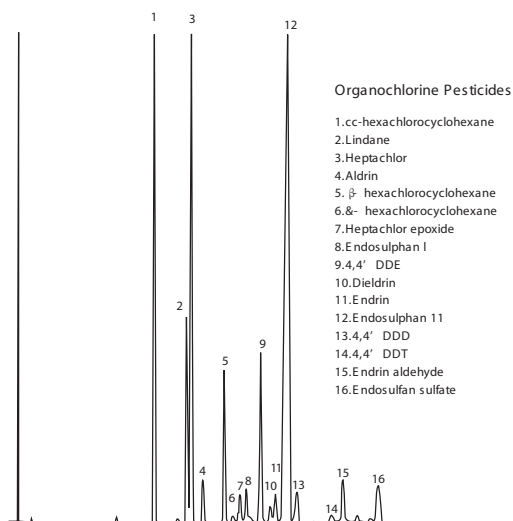

Column	WM-INOWAX, 30×0.32 mm, 0.25 μm; P/N: 03907-32001
Temperature	80 °C(maintain 1 min) $\xrightarrow{10\text{ }^{\circ}\text{C}/\text{min}}$ 200 °C(maintain 1 min) $\xrightarrow{5\text{ }^{\circ}\text{C}/\text{min}}$ 275 °C(maintain 3 min)
Injection port temperature	200 °C
Detector temperature	310 °C
Detector	F.I.D.

Volatile Organic Compounds (VOC)

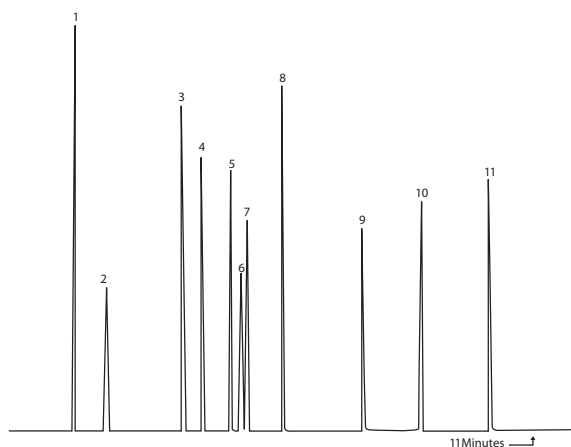

Volatile Organic Compounds (VOC)

- | | | | |
|----------------------|----------------------|------------------------|----------------------|
| 1.1,1-Dichloroethene | 4.Chloroform | 7.Carbon Tetrachloride | 10.Tetrachloroethene |
| 2.Methylene Chloride | 5.1,2-Dichloroethane | 8.Trichloroethene | 11.Chlorobenzene |
| 3.2-Butanone(MEK) | 6.Benzene | 9.Pyricine | |

Column	WM-624, 30×0.32 mm, 1.8 μm; P/N: 03908-32004
Temperature	40 °C(maintain 1 min) $\xrightarrow{10\text{ }^{\circ}\text{C}/\text{min}}$ 140 °C
Injection port temperature	200 °C
Detector temperature	250 °C

Ordering Information

Length*ID*Thick Film m*mm*μm	WM-1	WM-1MS	WM-5	WM-5MS	WM-1301	WM-1701
30*0.25*0.25	03901-22001	03903-22001	03902-22001	03904-22001	03905-22001	03907-22001
30*0.25*0.5	03901-22002	03903-22002	03902-22002	03904-22002	03905-22002	03907-22002
30*0.25*1.0	03901-22003	03903-22003	03902-22003	03904-22003	03905-22003	03907-22003
30*0.32*0.25	03901-32001	03903-32001	03902-32001	03904-32001	03905-32001	03907-32001
30*0.32*0.5	03901-32002	03903-32002	03902-32002	03904-32002	03905-32002	03907-32002
30*0.32*1.0	03901-32003	03903-32003	03902-32003	03904-32003	03905-32003	03907-32003
30*0.53*0.5	03901-52002	03903-52002	03902-52002	03904-52002	03905-52002	03907-52002
30*0.53*1.0	03901-52003	03903-52003	03902-52003	03904-52003	03905-52003	03907-52003
30*0.53*2.0	03901-52005	03903-52005	03902-52005	03904-52005	03905-52005	03907-52005

30*0.53*3.0	03901-52006	03903-52006	03902-52006	03904-52006	03905-52006	03907-52006
30*0.53*5.0	03901-52010	03903-52010	03902-52010	03904-52010	03905-52010	03907-52010
60*0.25*0.25	03901-24001	03903-24001	03902-24001	03904-24001	03905-24001	03907-24001
60*0.25*0.5	03901-24002	03903-24002	03902-24002	03904-24002	03905-24002	03907-24002
60*0.25*1.0	03901-24003	03903-24003	03902-24003	03904-24003	03905-24003	03907-24003
60*0.32*0.25	03901-34001	03903-34001	03902-34001	03904-34001	03905-34001	03907-34001
60*0.32*0.5	03901-34002	03903-34002	03902-34002	03904-34002	03905-34002	03907-34002
60*0.32*1.0	03901-34002	03903-34002	03902-34002	03904-34002	03905-34002	03907-34002

Length*ID*Thick Film m*mm*um	WM-624	WM-225	WM-17	WM-35	INOWAX	WM-FFAP
30*0.25*0.25	03908-22001	03919-22001	03916-22001	03921-22001	03909-22001	03911-22001
30*0.25*0.5	03908-22002	03919-22002	03916-22002	03921-22002	03909-22002	03911-22002
30*0.25*1.0	03908-22003	03919-22003	03916-22003	03921-22003	03909-22003	03911-22003
30*0.32*0.25	03908-32001	03919-32001	03916-32001	03921-32001	03909-32001	03911-32001
30*0.32*0.5	03908-32002	03919-32002	03916-32002	03921-32002	03909-32002	03911-32002
30*0.32*1.0	03908-32003	03919-32003	03916-32003	03921-32003	03909-32003	03911-32003
30*0.53*0.5	03908-52002	03919-52002	03916-52002	03921-52002	03909-52002	03911-52002
30*0.53*1.0	03908-52003	03919-52003	03916-52003	03921-52003	03909-52003	03911-52003
30*0.53*2.0	03908-52005	03919-52005	03916-52005	03921-52005	03909-52005	03911-52005
30*0.53*3.0	03908-52006	03919-52006	03916-52006	03921-52006	03909-52006	03911-52006
30*0.53*5.0	03908-52010	03919-52010	03916-52010	03921-52010	03909-52010	03911-52010
60*0.25*0.25	03908-24001	03919-24001	03916-24001	03921-24001	03909-24001	03911-24001
60*0.25*0.5	03908-24002	03919-24002	03916-24002	03921-24002	03909-24002	03911-24002
60*0.25*1.0	03908-24003	03919-24003	03916-24003	03921-24003	03909-24003	03911-24003
60*0.32*0.25	03908-34001	03919-34001	03916-34001	03921-34001	03909-34001	03911-34001
60*0.32*0.5	03908-34002	03919-34002	03916-34002	03921-34002	03909-34002	03911-34002
60*0.32*1.0	03908-34002	03919-34002	03916-34002	03921-34002	03909-34002	03911-34002

Not find the size you want? Contact Welch or your local distributor for other dimensions.

Welchrom[®] Series GC Packed Column

Stationary phase:

OV-1, OV-17, OV-101, OV-225, SE-30, SE-52, SE-54, PRG-400, PEG-600, PEG-1500, PEG-4000, PEG-6000, PEG-20M, DEGS, EGA, EGS, QF-1, FFAP, DNP, β , β - Diethoxyacetonitrile, silicone oil, apiezon, squalane, DC series and etc.

Supporter:

Aiatomite[Chrosorb series and others], organic support

Adsorbent and polymer microsphere:

Porapak series, Proasil series, GDX series, HDG series, SD series, molecular sieve, carbon molecular sieve, graphitized carbon black, silica gel, aluminium oxide, etc.

Specification:

Inner diameter 2-4 mm, length: 0.5-9 m.

Welch also offers custom-made GC packed columns. Please provide GC model number, column tube type, stationary phase composition, type and particle size of the solid support, inner diameter and length, and the targeted samples.

GC Packed Column Ordering Information

1.Packed Column Specification

Materials	3 mm(OD), 2 mm(ID)	4 mm(OD), 3 mm(ID)	1/8(OD), 2.0 mm(ID)	1/16(OD), 1.0 mm(ID)
Stainless Steel				
Passivated stainless steel				
Glass				
PP				

2.Materials

Support: (such as Chromosorb WAW DMCS)	Mesh Number:
Stationary Phase A: Coated Amount: %	Stationary Phase B: Coated Amount: %

3.Instrument Model

(Such as HP 5890/6890)

4.Dimension

Length:	OD:	ID:	For glass column, ID is required
---------	-----	-----	----------------------------------

Note: for glass column, ID and the center distance between injector and detector are required.

Packing Materials

— Best ingredients and patented technique to produce high quality packing materials

- Higher mechanical strength than competing analytical column packing materials
- Ultra-pure (purity > 99.999% SiO₂) spherical, and totally porous silica
- Proper particle size and narrow size distribution, and larger mass loading

Loading times and pressure

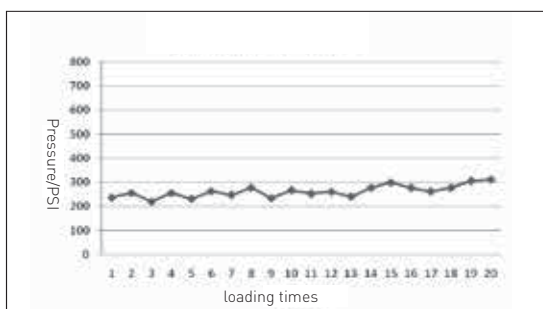

Loading times and column efficiency

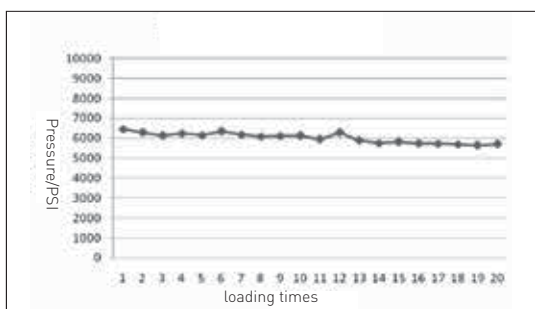

Ultra-low metal content

Method: ICP-MS

Items	Result(mg/kg)	LOD(mg/kg)
Na	Not detected	1.0
Mg	Not detected	1.0
Cd	Not detected	1.0
Cr	Not detected	1.0
Hg	Not detected	1.0
Cu	Not detected	1.0
Fe	Not detected	1.0
CA	Not detected	1.0



Easier to scale up: better separation, higher plate number, more cost saving

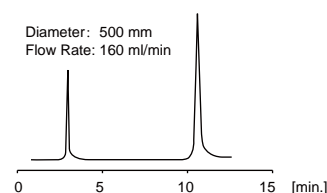
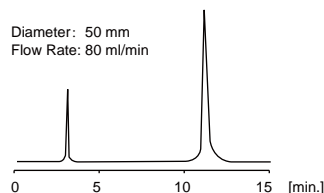
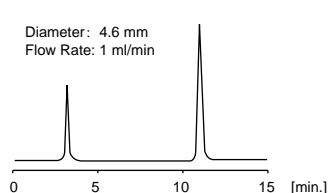

Stationary phase: Ultisil 120 Å C18, 10 μm
Column length: 250 mm Samples: uracil and methylbenzene

Mobile phase: methanol/water(75/25)
Detector: UV 254 nm

Good lot-to-lot reproducibility in 50-lot runs using Ultisil C18 10 μm 120 Å

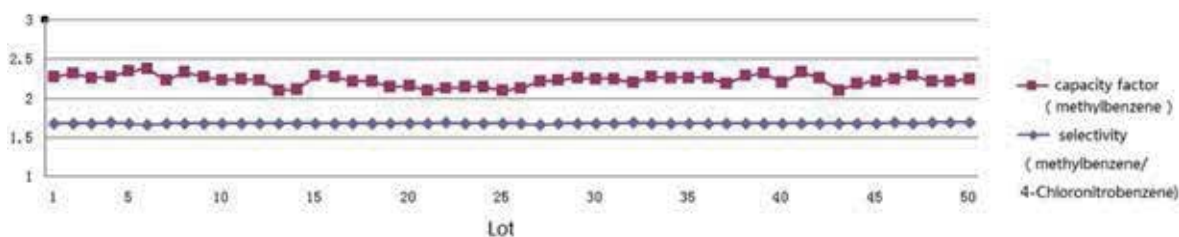

Stationary phase: Ultisil 120 Å C18, 10 μm Mobile phase: methanol/water(75/25) Flow rate: 1.0 ml/min
 Column length: 250 mm Samples: methylbenzene, 4-chloronitrobenzene Detector: UV 254 nm

pH Stability

pH 1.3

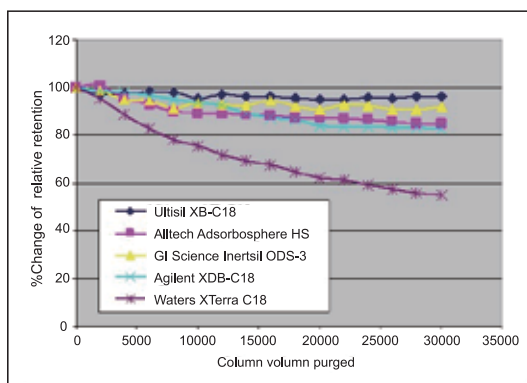

pH 10

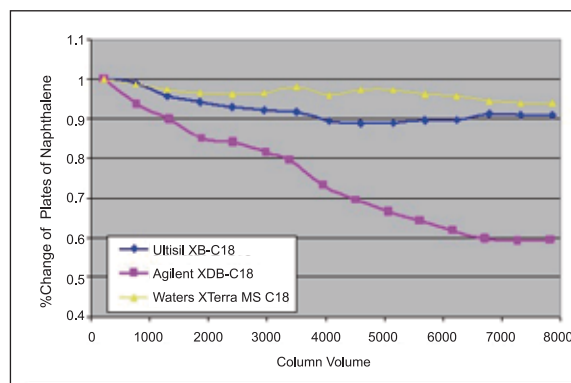

Ultisil™ Packing Materials

Packing Materials	Particle Size (μm)	Pore Size (Å)	Surface Area (m ² /g)	Carbon Load (%)	Endcapping	pH Stability
XB-C18	5, 10 μm	120	320 m ² /g	17	Yes	1.5-10.0
XB-C8	5, 10 μm	120	320 m ² /g	12	Yes	1.5-10.0
LP-C18	5, 10 μm	120	320 m ² /g	15	No	1.5-10.0
AQ-C8	5, 10 μm	120	320 m ² /g	12	Yes	1.5-10.0
XB-Phenyl	5, 10 μm	120	320 m ² /g	12	Yes	1.5-10.0
XB-CN	5, 10 μm	120	320 m ² /g	7	Yes	1.5-9.0
XB-NH ₂	5, 10 μm	120	320 m ² /g	4	No	/
XB-SiO ₂	5, 10 μm	120	320 m ² /g	0	No	/
XB-Diol	5, 10 μm	120	320 m ² /g	2.5	No	/

Welch also provides 300 Å packing materials.

Xtimate® Packing Materials

– Wide pH range, perfect peak shape!

Packing Materials	Particle Size (µm)	Pore Size (Å)	Surface Area (m ² /g)	Carbon Load (%)	Endcapping	pH Stability
Xtimate® C18	5, 10 µm	120	320 m ² /g	14	Yes	1.0-12.5
Xtimate® C8	5, 10 µm	120	320 m ² /g	10	Yes	1.0-12.5
Xtimate® Phenyl-Hexyl	5, 10 µm	120	320 m ² /g	12	No	1.0-12.5

Amorphous Silica-based Packing Materials

– Welch also provides amorphous silica-based packing materials for you to choose

- Ultra-pure (purity > 99.999% SiO₂), low metal content.
- Narrow size distribution
- High BET, large sample loading
- 40-63 µm, 35-70 µm and other suitable specifications, can be used for flash and SPE columns.

Ultisil™ Packing Materials

Phases	5 µm	7 µm	10 µm	15 µm	20 µm	20-40 µm	40-70 µm
XB-C18	02710-02100	02710-04100	02710-03100	02710-05100	02710-06100	02710-07100	02710-08100
AQ-C18	02712-02100	02712-04100	02712-03100	02712-05100	02712-06100	02712-07100	02712-08100
XB-C8	02720-02100	02720-04100	02720-03100	02720-05100	02720-06100	02720-07100	02720-08100
XB-C4	02760-02100	02760-04100	02760-03100	02760-05100	02760-06100	02760-07100	02760-08100
XB-C1	02722-02100	02722-04100	02722-03100	02722-05100	02722-06100	02722-07100	02722-08100
XB-Phenyl	02740-02100	02740-04100	02740-03100	02740-05100	02740-06100	02740-07100	02740-08100
XB-Diol	02711-02100	02711-04100	02711-03100	02711-05100	02711-06100	02711-07100	02711-08100
XB-CN	02750-02100	02750-04100	02750-03100	02750-05100	02750-06100	02750-07100	02750-08100
XB-NH ₂	02730-02100	02730-04100	02730-03100	02730-05100	02730-06100	02730-07100	02730-08100
XB-SiO ₂	02700-02100	02700-04100	02700-03100	02700-05100	02700-06100	02700-07100	02700-08100
Polar-RP	02718-02100	02718-04100	02718-03100	02718-05100	02718-06100	02718-07100	02718-08100
XB-C30	02724-02100	02724-04100	02724-03100	02724-05100	02724-06100	02724-07100	02724-08100
Hilic Amide	02743-02100	02743-04100	02743-03100	02743-05100	02743-06100	02743-07100	02743-08100
XB-SAX	02790-02100	02790-04100	02790-03100	02790-05100	02790-06100	02790-07100	02790-08100
XB-SCX	02714-02100	02714-04100	02714-03100	02714-05100	02714-06100	02714-07100	02714-08100

Xtimate® Packing Materials

Particle size	C18	C8	SiO ₂	NH ₂	Phenyl-Hexyl	CN	Polar-RP	SEC-120
5 µm	01710-02100	01720-02100	01760-02100	01730-02100	01770-02100	01750-02100	01718-02100	01745-02100
10 µm	01710-03100	01720-03100	01760-03100	01730-03100	01770-03100	01750-03100	01718-03100	01745-03100

Amorphous Silica-based Packing Materials

Particle size	C18	C8	SiO ₂
40-63 µm	00559-11053	00505-11053	00500-11053

Welchrom[®] SPE

Sample preparation is one of the most important steps for the entire analysis process, as over 60% of the process time and over 30% of the analysis errors come from the sample preparation step. Over the last twenty years, SPE has become the most powerful technique for the cleanup, purification, and concentration prior to analytical chromatography of samples from various matrices, including urine, blood, water, beverages, soil, and animal tissue. Solid phase extraction is a form of digital (step-wise) chromatography designed to extract, partition, and/or adsorb one or more components from a liquid phase (sample) onto the stationary phase (sorbent or resin). SPE extends the life time of a chromatographic system, improves qualitative and quantitative analyses, and by changing the original matrix environment of an analyte of interest to a simpler matrix more suitable for subsequent analysis, considerably lessens the demand placed on an analytical instrument.

Use SPE for samples that:

- Contain particulate matter causing system clogging and high back-pressure
- Contain components that cause high background, misleading peaks, and/or poor sensitivity
- Require cleanup, trace enrichment/concentration, or purification
- Require sample matrix or solvent exchange

Benefits of SPE

- Switch sample matrices to forms that are more compatible with chromatographic analyses
- Concentrate analytes for increased sensitivity
- Remove interferences to simplify chromatography and improve quantitation
- Protect analytical column from contaminants

Common SPE Applications

- Pharmaceutical compounds and metabolites in biological fluids
- Drugs of abuse in biological fluids
- Environmental pollutants in drinking and wastewater
- Pesticides and antibiotics in food/agricultural matrices
- Desalting of proteins and peptides
- Fractionation of lipids
- Water and fat soluble vitamins



Comparison Between SPE and HPLC

Items	HPLC	SPE
Tube	Stainless steel tube	Plastic tube
Particle size(μm)	3,5,10	40-300
Shape of particles	Spherical	Amorphous
Column efficiency	20-25,000	<100
Separate theory	Continuous elution	Digital switch elution
Price(\$)	160-650	2-7
Usage mode	Reusable	Disposable
Operate cost	High	Low
Equipment cost	High	Low

Welchrom[®] Polymeric SPE

Welchrom[®] Polymeric SPE is made from monodisperse polymer beads, whose surface is modified by Welch's unique surface modification and functionalization technology to produce various types of polymer SPE sorbents. Welchrom[®] SPE polymer beads have accurate particle size of 40 μm with a high degree of particle size and pore size uniformity, excellent surface area, and optimal bonding density of functional groups, which can meet high sensitivity analysis requirement for a wide variety of applications for acidic, neutral and basic compounds.

1. Welchrom[®] BRP

- BRP, an abbreviation for "Balanced Reverse Polymer", is modified by Welch's proprietary surface modification technology. It has balanced hydrophobic and hydrophilic adsorbent surface, and is used to separate polar and non-polar substances.
- Equivalent to Oasis HLB from Waters.

Technical Parameters

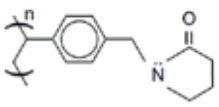
Matrix	Divinyl Benzene Polymer	
Function Groups	Modified N-Vinylbutyrolactam	
Material Characteristics	Particle Size: 40-60 μm Surface Area: 800-1000 m^2/g	Pore Size: 80 \AA pH Stability: 1-14
Retention Mechanism	Reverse Phase	
Applications	Non-polar, polar samples	

Ordering Information

Specification	Packing (pcs /bag)	Part No.
BRP 30 mg/1 ml	100	00522-20015
BRP 60 mg/3 ml	50	00522-20009
BRP 150 mg/3 ml	50	00522-20003
BRP 500 mg/3 ml	50	00522-20005
BRP 500 mg/6 ml	30	00522-20006
BRP 200 mg/6 ml	30	00522-20014
BRP 10 g/bottle	/	00522-20017

2. Welchrom[®] PS/DVB

- A highly cross-linked polystyrene-divinyl benzene copolymer sorbent that allows for rapid adsorption and separation of hydrophobic substances, such as phenols, surfactants, non-B pyridine bromides, antibiotics, amino acids and peptides, etc.
- Ideal for the extraction of polar analytes that are not adequately retained on a C18 or C8 sorbent. The nonselective characteristics of this sorbent is useful for screening applications where a broad range of analytes is to be extracted.
- Equivalent to Agilent's Bond Elute LMS, Bond Elute PPL.

Technical Parameters

Matrix	Divinyl Benzene Polymer	
Function Groups	Polystyrene/ Divinyl Benzene Polymer	
Material Characteristics	Particle Size: 40-60 μm Surface Area: 800-1000 m^2/g	Pore Size: 80 \AA pH Stability: 1-14
Retention Mechanism	Reverse Phase	
Applications	Moderate polar, non-polar samples	

Ordering Information

Specification	Packing (pcs /bag)	Part No.
PS/DVB 30 mg/1 ml	100	00526-20015
PS/DVB 60 mg/3 ml	50	00526-20009
PS/DVB 150 mg/6 ml	30	00526-20003

3. Welchrom® P-SCX

- Welchrom® P-SCX polymeric resin is a sulfonic acid-modified divinyl benzene polymer with both ion exchange and reverse phase retention properties.
- Allows for complete retention of basic compounds with a pKa between 2-10.
- Ideal solid phase extraction for melamine analysis, excellent retention for both basic and neutral compounds over a wide range of hydrophilicity, including melamine, amphetamine, chlorpheniramine, and phencyclidine.
- Equivalent to Waters' Oasis MCX.

Technical Parameters

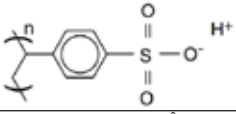
Matrix	Divinyl Benzene Polymer	
Function groups	Sulfonic Acid Ligand	
Material	Particle Size: 40-60 µm	Pore Size: 80 Å
Characteristics	Surface Area: 800-1000 m ² /g	pH Stability: 1-14
Retention Mechanism	Strong Cationic Mechanism	
Applications	Melamine, heterocycle samples with N	

Ordering Information

Specification	Packing (pcs /bag)	Part No.
P-SCX 30 mg/1 ml	100	00523-20015
P-SCX 60 mg/3 ml	50	00523-20016
P-SCX 150 mg/3 ml	50	00523-20003
P-SCX 200 mg/6 ml	30	00523-20014
P-SCX 500 mg/6 ml	30	00523-20006
P-SCX 10 g/bottle	/	00523-20017

4. Welchrom® P-SAX

- Welchrom® Strong Anion Exchange (SAX) polymeric resin is a mixed-mode, tertiary amine-modified divinyl benzene polymer that displays both anion exchange and reversed phase behavior.
- Allows for complete retention of acidic compounds with pKa between 2-8.
- Excellent retention for both acidic and neutral compounds over a wide range of hydrophilicity, typically used for purification of acidic substances, such as tyrosine, estrone, adenine and nucleoside and so on, from alkaline and neutral impurities.

Technical Parameters

Matrix	Divinyl Benzene Polymer	
Function Groups	Quaternary Ammonium Functional Groups	
Material	Particle Size: 40-60 µm	Pore Size: 80 Å
Characteristics	Surface Area: 800-1000 m ² /g	pH Stability: 1-14
Retention Mechanism	Strong Anion Mechanism	
Applications	Strong acid compounds, such as compound with sulfonic acid group, organic acid etc.	

Ordering Information

Specification	Packing (pcs /bag)	Part No.
P-SAX 30 mg/1 ml	100	00524-20015
P-SAX 60 mg/3 ml	50	00524-20016
P-SAX 150 mg/3 ml	50	00524-20003
P-SAX 200 mg/6 ml	30	00524-20014
P-SAX 500 mg/6 ml	30	00524-20006
P-SAX 10 g/bottle	/	00524-20017

5. Welchrom® P-WCX

- Welchrom® P-WCX resin is a weak cation exchange sorbent that displays both weak cation exchange and non-polar hydrophobic dual function.
- Allows for complete retention of strong basic compounds with a pKa greater than 10.
- Excellent separation of basic compound from acidic and neutral compounds, such as alkaloid, amino acid and clenbuterol, etc.

Technical Parameters

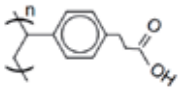
Matrix	Divinyl Benzene Polymer	
Function groups	Carboxylic Acid Ligand	
Material	Particle Size: 40-60 µm	Pore Size: 80 Å
Characteristics	Surface Area: 800-1000 m ² /g	pH Stability: 1-14
Retention Mechanism	Weak Cationic Mechanism	
Applications	Strong basic compounds, such as compounds that contain quaternary ammonium groups	

Ordering Information

Specification	Packing (pcs /bag)	Part No.
P-WCX 30 mg/1 ml	100	00539-20015
P-WCX 60 mg/3 ml	50	00539-20016
P-WCX 150 mg/3 ml	50	00539-20003
P-WCX 10 g/bottle	/	00539-20017

6. Welchchrom® P-WAX

- Welchchrom® P-WAX resin is a weak anion exchange sorbent that displays both weak anion exchange and non-polar hydrophobic dual function.
- Allows for complete retention of strong acidic compounds with a pKa less than 1.
- Excellent separation of acidic compound from basic and neutral compounds, such as phosphate tyrosine, estrone, adenine and nucleoside, etc.

Technical Parameters

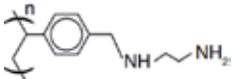
Matrix	Divinyl Benzene Polymer	
Function Groups	Carboxylic Acid Ligand 	
Material	Particle Size: 40-60 µm	Pore Size: 80 Å
Characteristics	Surface Area: 800-1000 m ² /g	pH Stability: 1-14
Retention Mechanism	Weak Anionic Mechanism	
Applications	Strong acid compounds, such as compounds with sulfonic acid group, organic acid group, etc.	

Ordering Information

Specification	Packing (pcs /bag)	Part No.
P-WAX 30 mg/1 ml	100	00525-20015
P-WAX 60 mg/3 ml	50	00525-20016
P-WAX 150 mg/3 ml	50	00525-20003
P-WAX 200 mg/6 ml	30	00525-20014
P-WAX 500 mg/6 ml	30	00525-20006
P-WAX 10 g/bottle	/	00525-20017

Welchchrom® Silica Based SPE

1. Welchchrom® C18E

Matrix	Silica Gel	
Function Group	C18E	
Endcapped	Yes	
Carbon Loading	17%	
Material	Particle Size: 40-60 µm	Pore Size: 60 Å
Characteristics	Pore Volume: 0.8 cm ³ /g	Surface Area: 480 m ² /g
Retention Mechanism	Reversed Phase	
Applications	Moderate polar, weak polar and non-polar samples	

Ordering Information

Specification	Packing (pcs /bag)	Part No.
C18E 100 mg/1 ml	100	00559-11001
C18E 100 mg/3 ml	50	00559-11002
C18E 150 mg/3 ml	50	00559-11003
C18E 200 mg/3 ml	50	00559-11004
C18E 500 mg/3 ml	50	00559-11005
C18E 500 mg/6 ml	30	00559-11006
C18E 1000 mg/6 ml	30	00559-11007
C18E 2 g/10 ml	20	00559-11008
C18E 10 g/bottle	/	00559-11017

2. Welchchrom® C18

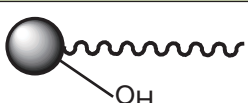
Matrix	Silica gel	
Function Group	C18	
Endcapped	No	
Carbon Loading	17%	
Material	Particle Size: 40-60 µm	Pore Size: 60 Å
Characteristics	Pore Volume: 0.8 cm ³ /g	Surface Area: 480 m ² /g
Retention Mechanism	Reversed Phase	
Applications	Moderate polar, weak polar and polar samples	

Ordering Information

Specification	Packing (pcs /bag)	Part No.
C18 100 mg/1 ml	100	00504-11001
C18 100 mg/3 ml	50	00504-11002
C18 150 mg/3 ml	50	00504-11003
C18 200 mg/3 ml	50	00504-11004
C18 500 mg/3 ml	50	00504-11005
C18 500 mg/6 ml	30	00504-11006
C18 1000 mg/6 ml	30	00504-11007
C18 10 g/bottle	/	00504-11017

3. Welchrom[®] Silica

Matrix	Silica gel	
Function Groups	Si-OH	
Endcapped	No	
Material	Particle Size: 40-60 µm	Pore Size: 60 Å
Characteristics	Pore Volume: 0.8 cm ³ /g Surface Area: 480 m ² /g	
Retention Mechanism	Normal Phase	
Applications	Moderate, polar samples	

4. Welchrom[®] NH₂

Matrix	Silica gel	
Function Groups	NH ₂	
Endcapped	No	
Carbon Loading	3.5%	
Material	Particle Size: 40-60 µm	Pore Size: 60 Å
Characteristics	Pore Volume: 0.8 cm ³ /g Surface Area: 480 m ² /g	
Retention Mechanism	Normal Phase	
Applications	Moderate polar, polar samples	

5. Welchrom[®] PSA

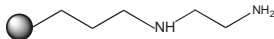
Matrix	Silica Gel	
Function Groups	Ethylenediamine	
Endcapped	Yes	
Carbon Loading	7%	
Material	Particle Size: 40-60 µm	Pore Size: 60 Å
Characteristics	Pore Volume: 0.8 cm ³ /g Surface Area: 480 m ² /g	
Retention Mechanism	Normal Phase	
Applications	Moderate polar, polar samples	

6. Welchrom[®] SCX

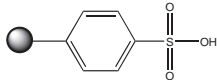
Matrix	Silica gel	
Function Groups	Benzene sulfonic acid group	
Endcapped	No	
Carbon Loading	2.5%	
Material	Particle Size: 40-60 µm	Pore Size: 60 Å
Characteristics	Pore Volume: 0.8 cm ³ /g Surface Area: 480 m ² /g	
Retention Mechanism	Strong cation-exchange selectivity	
Applications	Extract positively charged basic compounds	

Ordering Information

Specification	Packing (pcs /bag)	Part No.
Silica 100 mg/1 ml	100	00500-11001
Silica 200 mg/3 ml	50	00500-11004
Silica 500 mg/3 ml	50	00500-11005
Silica 500 mg/6 ml	30	00500-11006
Silica 1000 mg/6 ml	30	00500-11007
Silica 10 g/bottle	/	00500-11017

Ordering Information

Specification	Packing (pcs /bag)	Part No.
NH ₂ 100 mg/1 ml	100	00509-11001
NH ₂ 100 mg/3 ml	50	00509-11002
NH ₂ 150 mg/3 ml	50	00509-11003
NH ₂ 200 mg/3 ml	50	00509-11004
NH ₂ 500 mg/3 ml	50	00509-11005
NH ₂ 500 mg/6 ml	30	00509-11006
NH ₂ 1000 mg/6 ml	30	00509-11007
NH ₂ 10 g/bottle	/	00509-11017

Ordering Information

Specification	Packing (pcs /bag)	Part No.
PSA 100 mg/1 ml	100	00508-11001
PSA 200 mg/3 ml	50	00508-11004
PSA 500 mg/3 ml	50	00508-11005
PSA 500 mg/6 ml	30	00508-11006
PSA 1000 mg/6 ml	30	00508-11007
PSA 10 g/bottle	/	00500-11017

Ordering Information

Specification	Packing (pcs /bag)	Part No.
SCX 100 mg/1 ml	100	00512-11001
SCX 200 mg/3 ml	50	00512-11004
SCX 500 mg/3 ml	30	00512-11005
SCX 500 mg/6 ml	30	00512-11006
SCX 1000 mg/6 ml	30	00512-11007
SCX 10 g/bottle	/	00512-11017

Welchrom[®] Inorganic SPE

1. Welchrom[®] Florisil PR (pesticide residue grade)

Matrix	Magnesium Silicate
Material Characteristics	Particle size: 60/100 mesh (150-200 mm)
Function Groups	Silicon Hydroxyl
Retention Mechanism	Normal Phase
Applications	Pesticides and environmental samples

Ordering Information

Specification	Packing (pcs /bag)	Part No.
Florisil PR 100 mg/1 ml	100	00516-20001
Florisil PR 200 mg/3 ml	50	00516-20004
Florisil PR 500 mg/3 ml	50	00516-20005
Florisil PR 500 mg/6 ml	30	00516-20006
Florisil PR 1000 mg/6 ml	30	00516-20007
Florisil PR 10 g/bottle	/	00516-20017

2. Welchrom[®] Alumina-N

Matrix	Magnesium Silicate
Material Characteristics	Particle Size: 60/100 mesh (150-200 mm)
Function Groups	Aluminum Hydroxyl
Retention Mechanism	Normal Phase
Applications	Moderate polar, polar samples

Ordering Information

Specification	Packing (pcs /bag)	Part No.
Alumina-N 100 mg/1 ml	100	00518-20001
Alumina-N 200 mg/3 ml	50	00518-20004
Alumina-N 500 mg/3 ml	50	00518-20005
Alumina-N 500 mg/6 ml	30	00518-20006
Alumina-N 1000 mg/6 ml	30	00518-20007
Alumina-N 10 g/bottle	/	00518-20017

3. Welchrom[®] GraphiCarb

Matrix	Graphite
Function Groups	Carbon six-member ring
Retention Mechanism	Reversed Phase
Applications	Ideal for moderate polar, polar compounds and aromatic compounds

Ordering Information

Specification	Packing (pcs /bag)	Part No.
Carb 100 mg/1 ml	100	00517-20001
Carb 100 mg/3 ml	50	00517-20002
Carb 200 mg/3 ml	50	00517-20004
Carb 500 mg/6 ml	30	00517-20006
Carb 1000 mg/6 ml	30	00517-20007
Carb 250 mg/3 ml	50	00517-20012
Carb 250 mg/6 ml	30	00517-20013
Carb 10 g/bottle	/	00517-20017

Welchrom[®] Mixed Mode SPE

1. Welchrom[®] C8/SCX

Matrix	Silica Gel
Function Groups	C8/ sulfonic acid group
Carbon Loading	12
Retention Mechanism	Reversed phase, cation-exchange selectivity
Applications	Ideal for cationic compounds, such as melamine and clenbuterol

Ordering Information

Specification	Packing (pcs /bag)	Part No.
C8/SCX 100 mg/1 ml	100	00556-11001
C8/SCX 200 mg/3 ml	50	00556-11004
C8/SCX 500 mg/3 ml	50	00556-11005
C8/SCX 500 mg/6 ml	30	00556-11006
C8/SCX 1000 mg/6 ml	30	00556-11007

2. Welchrom[®] GraphiCarb/NH₂

Matrix	Graphite, silica gel
Function Groups	Carbon six-member ring/NH ₂
Retention Mechanism	Reversed and normal phase
Applications	Ideal for pesticide residue

Ordering Information

Specification	Packing (pcs /bag)	Part No.
Carb/NH ₂ 250 mg/250 mg, 6 ml	30	00527-20010
Carb/NH ₂ 500 mg/500 mg, 6 ml	30	00527-20011

3. Welchrom[®] SAX/PSA

Matrix	Silica Gel
Function Groups	Quaternary ammonium groups, Ethylenediamine functional groups
Retention Mechanism	Normal phase, anion-exchange selectivity
Applications	Ideal for pesticide residue

Ordering Information

Specification	Packing (pcs /bag)	Part No.
SAX/PSA 500 mg/500 mg/6 ml	30	00569-11011

4. Welchrom[®] GraphiCarb/PSA

Matrix	Carb, Silica gel
Function Groups	Graphite Ethylenediamine functional groups
Retention Mechanism	Reversed and normal phase
Applications	Ideal for pesticide residue

Ordering Information

Specification	Packing (pcs /bag)	Part No.
Carb/PSA 500 mg/500 mg/6 ml	30	00548-20011

Welchrom[®] Special SPE

1. Welchrom[®] BaP_(benzopyrene)

Matrix	Neutral Alumina
Function Groups	Aluminum Hydroxy
Retention Mechanism	Normal Phase
Applications	Benzopyrene

Ordering Information

Specification	Packing (pcs /bag)	Part No.
BaP, 22 g/60 ml	10	00547-20037

2. Welchrom[®] Special Column for Plasticizer

Matrix	Polymer
Retention Mechanism	Reversed and normal phase
Applications	Ideal for moderate polar, non-polar compounds W-PTC: extract phthalate from water or white spirit O-PTC: extract phthalate from oil (non-aqueous solvent) and white spirit

Ordering Information

Specification	Packing (pcs /bag)	Part No.
W-PTC(water) 1 g/6 ml	30	09566-11011
O-PTC(oil) 1 g/6 ml	30	09566-20007

3. Welchrom[®] TPT_(special for tea leaf)

Ordering Information

Specification	Packing (pcs /bag)	Part No.
TPT, 1 g/6 ml	30	00545-20011
TPT, 2 g/10 ml	20	00545-20061

4. Welchrom[®] TPH_(special for Chinese herbal medicine)

Ordering Information

Specification	Packing (pcs /bag)	Part No.
TPH, 1 g/6 ml	30	00568-20007
TPH, 2 g/10 ml	20	00568-20008

5. Welchrom[®] Special Column for Sudan Red

Ordering Information

Specification	Packing (pcs /bag)	Part No.
SDD, 500 mg/6 ml	100	00566-20006

Welchrom[®] QuEChERS

--- A Simplified Method of Sample Preparation for Pesticide Analysis

What is QuEChERS?

QuEChERS (pronounced "catchers") stands for Quick, Easy, Cheap, Effective, Rugged and Safe-the qualities that describe this sample preparation method for food substances. The technique is quite simple, involving a minimum of steps, and is effective for the cleanup of complex samples.

QuEChERS is an upgraded version of SPE. They have similar functions, but the preparation method of QuEChERS is much easier. With QuEChERS, you can prepare your samples for multi-class, multi-residue analysis while saving time and money. In the United States, the Association of Official Analytical Chemists (AOAC) has published its 2007.01 Method while the European equivalent, the EN 15662 2007, uses similar methodology.

Why Welchrom[®] QuEChERS?

- Saving time and money for your sample preparation
- High quality, best reproducibility
- Excellent accuracy and reproducibility
- Lower impurity from internal sources by packing with Welchrom[®] SPE packing materials, and use aluminum foil packing to prevent contamination from external sources
- Lower cost as compared to other brands.



How Does Welchrom[®] QuEChERS Work?

QuEChERS extraction method is designed for multi-residue pesticide analysis of fruits and vegetables with high water content (80%-95%). Some compounds will interfere with the detection of target pesticide, such as chlorophyll, fatty acid, pigment. These compounds can be removed by QuEChERS.

Some QuEChERS methods add buffers during the extraction step. Two most common methods are the European Committee for Standardization (CEN 15662) method that applies citrate buffer for extraction and the Association of Analytical Communities (AOAC 2007.01) method that uses acetic acid buffer.

For low-water content fruits and vegetables, additional water needs to be added to optimize the extraction. For fruits and vegetables of high-fatty content, C18E should be added to remove it. For fruits and vegetables of high-pigment content, graphiticarb should be added.

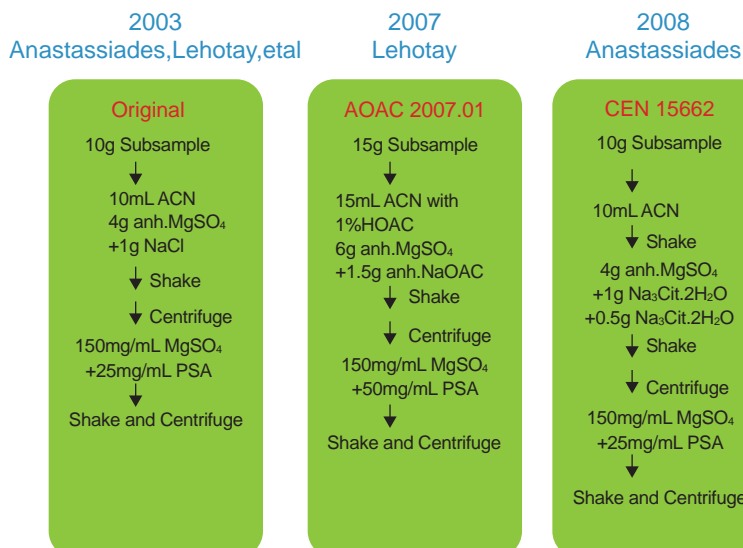

Welchrom® QuEChERS Workflow

Step 1: Extraction

Transfer homogenized sample (10 g or 15 g) to a 50 ml tube; then add extraction solvent and salt; shake for one minute, and then centrifuge > 1500 rcf for 1 minute.

Welchrom® QuEChERS Extraction Kits:

- 50 ml tubes
- Pre-packaged MgSO₄, NaCl or other salts

Welchrom® QuEChERS Extraction Kits Ordering Information (without 50 ml tubes)

		Pack Size	Part Numbers
AOAC 2007.01	6 g MgSO ₄ , 1.5 g NaAC	100	00528-00000
EN 15662	4 g MgSO ₄ , 1 g NaCl, 1 g NaCitrates, 0.5 g disodium citrate sesquihydrate	100	00529-00000
Original	4 g MgSO ₄ , 1 g NaCl	100	00530-00000

Step 2: Clean up

Choose a right clean up tube; transfer the extracted sample in Step 1 to the clean-up tube; shake for 30 seconds, then centrifuge > 1500 rcf for 1 minute.



		Tubes/ ml	Pack Size	MgSO ₄ /mg	PSA /mg	C18E /mg	GCB /mg	Part Number
General fruits and vegetables	AOAC 2007.01	2	100	150	50	/	/	00531-20020
		15	50	1200	400	/	/	00531-20021
	EN 15662	2	100	150	25	/	/	00532-20020
		15	50	900	150	/	/	00532-20021
Waxy or fatty fruits and vegetables	AOAC 2007.01	2	100	150	50	50	/	00533-20020
		15	50	1200	400	400	/	00533-20021
	EN 15662	2	100	150	25	2	/	00534-20020
		15	50	900	150	150	/	00534-20021
Pigment content fruits and vegetables	AOAC 2007.01	2	100	150	50	/	50	00535-20020
		15	50	120	400	/	400	00535-20021
	EN 15662	2	100	150	25	/	2.5	00536-20020
		15	50	900	150	/	15	00536-20021
Highly pigmented and fatty fruits and vegetables	AOAC 2007.01	2	100	150	50	/	50	00537-20020
		15	50	1200	400	/	400	00537-20021
Highly pigmented fruits and vegetables	EN 15662	2	100	150	25	/	2.5	00538-20020
		15	50	900	150	/	15	00538-20021





What Are These Sorbents Used for?

MgSO ₄	Remove H ₂ O in the matrix
PSA	Adsorb carbohydrates, fatty acids, organic acids and some pigments in the matrix
C18E	Remove non-polar compounds in the matrix
GCB	Remove pigments and sterols in the matrix

Suggest Welchrom QuEChERS Extraction Kits by Food Type

General fruits and vegetables, lightly colored samples	Waxy or fatty fruits and vegetables (>1% fat/lipids)	Pigment content fruits and vegetables	Highly pigmented and fatty fruits and vegetables	Highly pigmented fruits and vegetables
Fruits: apple, pear, quince, apricot, cherry, Mirabelle, nectarine, peach, plum, grapes(green), raspberry, strawberry, avocado, banana, mango, melon, olives, papaya, pineapple	Fruits: citrus juices, grapefruit, lemon, orange, nectarine, tangerine, banana, fig, kiwi.	Fruits: blackberry, blue berry, cranberry, currant, elderberry, grape(red), gooseberry(red), raisin, raspberry.	Fig(dried), kiwi.	Fruits: blackberry, blue berry, cranberry, currant, elderberry, grapes(red), gooseberry(red), raisin, raspberry, papaya, pineapple.
Vegetables: Beets, black salsify, carrot, celeriac, horseradish, parsley root, potato, radish, chive, garlic, leek, onion, scallion, eggplant, cucumber, tomato, zucchini, broccoli, Brussels sprouts, cabbage(red, white), kale, kohlrabi, arugula, artichokes, asparagus, celery, leek, rhubarb, beans	Vegetables: chive, garlic.	Vegetables: leek, shallot, aubergine, pepper(green), pepper(red), zucchini, cabbage(red), cabbage(white), kale, kohlrabi, arugula, basil, cilantro, cress, endive, lamb's lettuce, lettuce varieties, parsley, spinach, leek, beans(dried)		Vegetables: leek, shallot, aubergine, pepper(green), cabbage(red), kale, kohlrabi, arugula, basil, cilantro, cress, endive, lamb's lettuce, lettuce varieties, parsley, spinach, beans(dried)
EN or AOAC	EN or AOAC	EN or AOAC	AOAC	EN
00531-20020	00533-20020	00535-20020	00537-20020	00538-20020
00531-20021	00533-20021	00535-20021	00537-20021	00538-20021
00532-20020	00534-20020	00536-20020		
00532-20020	00534-20021	00536-20021		

Bulk Sorbents

	Sorbent Name	Part Number	Specification	Packing Size
	PSA	00508-11018	100 g/bottle	/
	NH ₂	00609-11018	100 g/bottle	/
	C18E	00501-11018	100 g/bottle	/
	GCB	00517-20018	100 g/bottle	/
	PSA	00508-11004	200 mg/3 ml	50
		00508-11006	500 mg/6 ml	30
	NH ₂	00509-11004	200 mg/3 ml	50
		00509-11006	500 mg/6 ml	30
	C18E	00501-11004	200 mg/3 ml	50
		00501-11006	500 mg/6 ml	30
	GCB	00517-20004	200 mg/3 ml	50
		00517-20006	500 mg/6 ml	30
	Garb/NH ₂	00527-20010	250 mg/250 mg, 3 ml	50
		00527-20011	500 mg/500 mg, 6 ml	30

Sail 1000 HPLC Instrument

Pump

Flow Setting Range	0.001~9.999 ml/min, 0.001 ml/min step length
Flow Value Error	± 0.3%
Flow Value Precision	0.05%
Gradient Error	± 0.5%
Gradient Precision	0.3%
Pressure Range	≤ 42 Mpa (316 LPump head)

VWD

Detector System	190-700 nm Wavelength
Wavelength Coverage	190 nm-700 nm, Step Length 1 nm
Wavelength Accuracy	1 nm
Wavelength Precision	±0.1 nm
Dynamic Baseline Noise	±1.0×10 ⁻⁵ AU
Dynamic Baseline Drift	2.0×10 ⁻⁴ AU/h
Minimum Detectable Concentration	3×10 ⁻⁹ g/ml

Performance







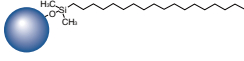
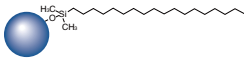
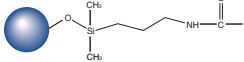
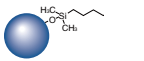
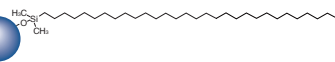
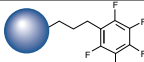
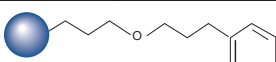

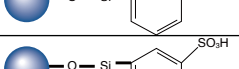

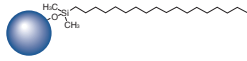
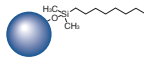
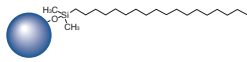
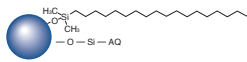
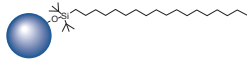
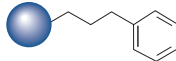
Qualitative Repeatability	≤0.1%
Quantitative Repeatability	≤0.2%

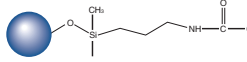

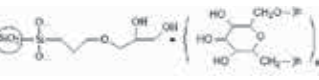
Welch Column List

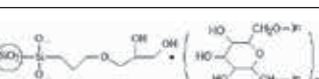
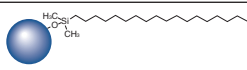
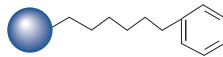
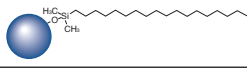
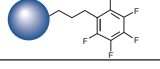
Structural Formula	Column	pH Range	Surface Area(m ² /g)	Pore Size(Å)	Carbon Loading(%)	USP List
	Welchrom® C18	1.5-10	320	120	19	L1
	Welchrom® C8	1.5-10	320	120	12	L7
	Ultisil™ AQ-C18	1.5-10	320	120	12	L1
	Ultisil™ Amino Acid	1.5-10	320	120	17	L1
	Ultisil™ LP-C18	0.5-8.0	320	120	10	L1
	Ultisil™ LP-aq	1.0-8.0	320	120	5	L1
	Ultisil™ LP-C18	0.5-8.0	90	300	5	L1
	Ultisil™ LP-C8	1.0-8.0	320	120	5.5	L7
	Ultisil™ LP-CN	1.0-8.0	320	120	6	L10
	Ultisil™ XB-C18	1.5-10	320	120	17	L1
	Ultisil™ XB-C18	1.5-10	90	300	8	L1
	Ultisil™ XB-C8	1.5-10	320	120	12	L7
	Ultisil™ Polar RP	1.5-10	320	120	18	L1/L60
	Ultisil™ XB-C4	1.5-10	320	120	8	L26
	Ultisil™ XB-C4	1.5-10	90	300	3	L26
	Ultisil™ XB-C1	1.5-10	320	120	4	L13
	Ultisil™ C30	1.5-10	320	120	17	L62
	Ultisil™ PAH	1.5-10	320	120	22	L1
	Ultisil™ XB-Phenyl	1.5-10	320	120	12	L11
	Ultisil™ XB-Phenyl	1.5-10	90	300	4	L11
	Ultisil™ PFP	1.5-10	320	120	C 13%; F 7%	L11/L43
	Ultisil™ Phenyl-Ether	1.5-10	320	120	12%	L11

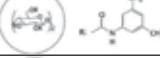
	Ultisil™ F-C8	1.5-10	320	120	12	L7
	Ultisil™ MM NH ₂ /CN	2.0-8.0	320	120	/	/
	Ultisil™ MM C18/SCX	2.0-8.0	320	120	/	/
	Ultisil™ HILIC Amide	2.0-8.0	320	120	7%	/
	Ultisil™ Alk-C18	1.5-10	320	120	12	L1
	Ultisil™ Plus C18	2.0-8.0	160	130	10	L1
	Ultisil™ XB-CN	1.5-9.0	320	120	7	L10
	Ultisil™ XB-NH ₂	2.0-8.0	320	120	4	L8
	Ultisil™ SiO ₂	2.0-8.0	320	120	/	L3
	Ultisil™ Diol	2.0-8.0	320	120	2.5	L20
	Ultisil™ XB-SCX	2.0-8.0	320	120	C 12%, S 2.2%	/
	Ultisil™ XB-SCX	2.0-8.0	90	300	/	/
	Ultisil™ XB-SAX	2.0-8.0	320	120	C:7.5%	L14
	Ultisil™ XB-SAX	2.0-8.0	90	300	/	L14
	Xtimate® C18	1.0-12.5	320	120	14	L1
	Xtimate® C8	1.0-12.5	320	120	10	L7
	Xtimate® C4	1.0-12.5	320	120	8	L26
	Xtimate® CN	1.0-12.5	320	120	7	L10
	Xtimate® Phenyl-Hexyl	1.0-12.5	320	120	12	L11
	Xtimate® Poalr RP	1.5-12.5	320	120	16	L1
	Topsil® C18	2-9.5	260	150	12	L1
	Topsil® C8	2-9.5	260	150	10	L7
	Topsil® Phenyl-Hexyl	2-9.5	260	150	12%	L11
	Topsil® NH ₂	2.0-8.0	260	150	3	L8
	Topsil® CN	2.0-8.0	260	150	6	L10

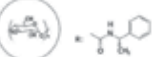
	Topsil® Silica	2.0-8.0	260	150	/	L3
	Ultisil™ UHPLC XB-C18	1.5-10	320	120	17	L1
	Ultisil™ UHPLC XB-C8	1.5-10	320	120	12	L7
	Xtimate® UHPLC C18	1.0-12.5	320	120	14	L1
	Ultisil™ UHPLC AQ-C18	1.5-10	320	120	12	L1
	Ultisil™ UHPLC LP-C18	0.5-8	320	120	10	L1
	Ultisil™ UHPLC XB-Phenyl	1.5-10	320	120	13	L11
	Ultisil™ UHPLC SiO ₂	2.0-8.0	320	120	/	L3
	Ultisil™ UHPLC Polar RP	1.5-10	320	120	18	L1
	Xtimate® Sugar-Ca	5-9	8% crosslinking degree	No Pore	/	L19
	Xtimate® Sugar-H	1-3	8% crosslinking degree	No Pore	/	/
	Xtimate® PS/DVB	1.0-14.0	450	300	/	/
	Xtimate® SEC-120	2 - 7.5, 8.5-9.5 at short time	Protein Molecular Weight Range 500-150,000	120	Water-soluble Molecular Range 500-25,000	/
	Xtimate® SEC-300	2 - 7.5, 8.5-9.5 at short time	Protein Molecular Weight Range 5,000 - 1,250,000	300	Water-soluble Molecular Range 1,000-100,000	/
	Xtimate® SEC-700	2 - 7.5, 8.5-9.5 at short time	Protein Molecular Weight Range 15,000 - 5,000,000	700	Water-soluble Molecular Range 2,500-500,000	/
	Xtimate® SEC-1000	2 - 7.5, 8.5-9.5 at short time	Protein Molecular Weight Range 50,000 - 7,500,000	1000	Water-soluble Molecular Range 5,000-1,500,000	/
	Boltimate™ C18(Core-shell)	2-8.5	120	90	9	L1
	Boltimate™ Phenyl-Hexyl (Core-shell)	2-8.5	120	90	7	L11
	Boltimate™ EXT-C18 (Core-shell)	1.5-12.5	120	90	8	L1
	Boltimate™ EXT-PFP (Core-shell)	1.5-10.0	120	90	5	L43
	Boltimate™ HILIC (Core-shell)	2.0-8.5	120	90	-	L3
	Ultisil™ Cellu-D/Cellu-DR	2.0-9.0	120	320	-	L40
	Ultisil™ Cellu-J/Cellu-JR	2.0-9.0	120	320	-	L80
	Ultisil™ Amy-D/Amy-DR	2.0-9.0	120	320	-	L51
	Ultisil™ Amy-S/Amy-SR	2.0-9.0	120	320	-	-

Welch Column Can Substitute

Ultisil XB-C18 can substitute:

Symmetry C18	Symmetry shield RP C18	
Luna C18	Luna C18(2)	Discovery C18
Hypersil BDS C18	Alltima C18	Zobax Eclipse C18
BetaBasic C18	Platinum EPS C18	Betasil C18
Inertsil ODS-2	Inertsil ODS-3	Supelcosil LC-18-DB
Kromasil 100A C18	HyPURITY C18	

Ultisil AQ-C18 can substitute:

Aquasil C18	Atlantis C18
Zorbax SB-AQ C18	Synergi Hydro-RP C18
HydroBond PS C18	HydroBond AQ C18
Ultra Aqueous C18	Prontosil C18 AQ
YMC-Pack ODS-AQ	Elite Sino Chrom ODS-BP

Ultisil XB-C8 can substitute:

Symmetry C8	Luna C8	Luna C8(2)
Discovery C8	Hypersil BDS C8	Alltima C8
Zorbax Eclipse XDB C8	BetaBasic C8	Platinum EPS C8
Betasil C8	Inertsil C8	Inertsil C8-3
Supercosil LC-8-DB	Kromasil 100A C8	HyPURITY C8
YMC-Pack C8-AM	Adsorbosphere HS C8	Develosil C8
Cosmosil C8-MS	Nucleosil 100 C8 HD	

Other Ultisil Columns: XB-CN, XB-Phenyl, XB-CN, SiO₂ and Polar RP can replace the most of the same type columns of other brands.

Xtimate[®] (wide pH range) can substitute:

Waters	Xterra series
	Xbridge series
Agilent	Extend series
Phenomenex	Gemini series

Chiral Column Reference Table

Company	Brand	Coated Normal Phase				Coated Reversed Phase			
		Cellu-D	Cellu-J	Amy-D	Amy-S	Cellu-D/R	Cellu-J/R	Amy-D/R	Amy-S/R
Welch	Ultisil	Cellu-D	Cellu-J	Amy-D	Amy-S	Cellu-D/R	Cellu-J/R	Amy-D/R	Amy-S/R
Daicel	Chiralcel	OD-H	OJ-H			OD-RH	OJ-RH		
	Chiralpak			AD-H	AS-H			AS-RH	AS-RH

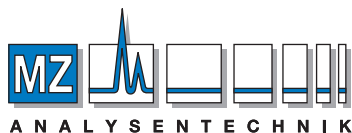

AUTHORIZED DISTRIBUTOR

MZ-Analysentechnik GmbH, Barcelona-Allee 17• D-55129 Mainz
Tel +49 6131 880 96-0, Fax +49 6131 880 96-20
e-mail: info@mz-at.de, www.mz-at.de

Welch Materials (Shanghai), Inc.

Suite 1001B, Tower A, Building 1, 3000 Longdong, Pudong Shanghai 201203, China
Tel: 400-808-6760
Fax:+86-21-50276769

Welch Materials (Zhejiang), Inc.

No. 168 Shuanglin South Street, Jinhua, Zhejiang 321016, China
Tel: +86-579-82795008
Fax:+86-579-82795006

Hangzhou Welch Scientific Instrument Co., Ltd.

Room A1306, Building 2, No. 452, 6th Avenue, Baiyang Street,
Economic and Technological Development Zone, Hangzhou, Zhejiang 330018, China
Tel: +86-571-86811001
Fax:+86-571-86819393

Welch Materials, Inc.

9506 Big View Dr. Austin, TX 78730, USA
Tel: +1(410) 988-2362

Welch Materials (India), Pvt. Ltd.

Room 838, JMD Megapolis, Sohna Road, Gurgaon 122018, Haryana, India
Tel: +91-1244920948
Fax:+91-1244920947

Email: info@welchmat.com
www.welch-us.com

Quality, Innovation, Competitive Price

