

COSMOSIL/COSMOCORE Technical Notes

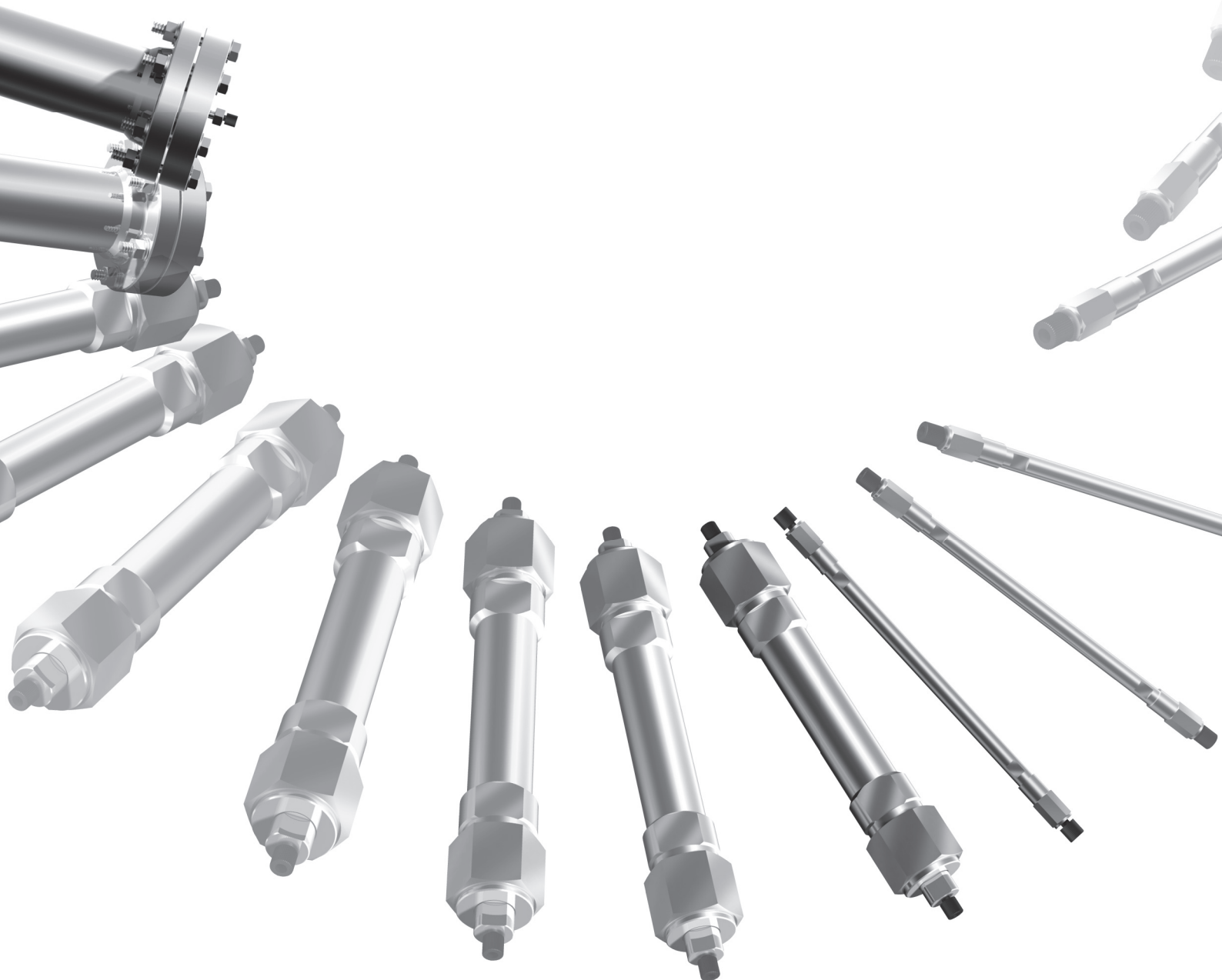



COSMOSIL

COSMOSIL Applications

COSMOSIL Application has more than 7,600 applications using COSMOSIL columns. Setting optimal HPLC experimental parameters is an important process that requires experience and time. COSMOSIL Applications provide you with sample analysis conditions for widely used ODS columns and our specialty columns.

- Over 7,600 applications
- Easy to search

Visit COSMOSIL top page at
<http://www.nacalai.co.jp/global/cosmosil/>

Applications are searched by

1. Sample Category
2. Sample Name
3. CAS No.
4. Column Name
5. Particle Size

Search Result

COSMOSIL Application

Search condition: [Application No=AP-1206]
 [TOP]

Results 1 (1-1)

Data No.	Data Name	Particle Size	Column
Sample		CAS No.	
AP-1206	Dichlorophenol	5	mNAP
2	Dichlorophenol		576-24-9
2	Dichlorophenol		120-83-2
2	Dichlorophenol		583-78-8
2	Dichlorophenol		87-65-0
3	Dichlorophenol		95-77-2
3	Dichlorophenol		591-35-5

COSMOSIL Application

COSMOSIL Application

COSMOSIL Application Data

click to enlarge

Data No.	AP-1024
Data Name	Berberine

1. FAQ and Troubleshooting	4
(1) FAQ and Troubleshooting List	4
(2) FAQ	5
(3) Troubleshooting	12
2. Liquid Chromatography Basics	18
3. Technical Information	23
(1) Preparation of Mobile Phase for HPLC	23
(2) Scale Up and Scale Down	25
(3) Troubleshooting for Increased Pressure	29
(4) Sample Pretreatment for HPLC	31
(5) Baseline Noise in Gradient Elution	36
(6) Guard Column Selection and Use	37
(7) Selectivity of Packing Materials in Reversed Phase Liquid Chromatography	39
(8) Methods for Developing Mobile Phase Conditions for C ₁₈ Columns	46
(9) Comparison with Old Type COSMOSIL	51

1.FAQ and Troubleshooting

(1) FAQ and Troubleshooting List

• FAQ		Page
Q1	What is the pressure limit of COSMOSIL columns?	5
Q2	What is the flow rate limit?	
Q3	What is the recommended pH range?	
Q4	What is the concentration of buffer and salt?	
Q5	How do I prepare the mobile phase?	6
Q6	What solvent grade should I use for the mobile phase?	
Q7	Should I use acetonitrile or methanol for the mobile phase?	
Q8	Which mobile phase can be used for LC/MS or ELSD detector?	7
Q9	What should I pay attention to when using ion-pairing reagents?	
Q10	What flow direction should I use for the mobile phase?	
Q11	What is the recommended column oven temperature?	
Q12	What is the shipping solvent?	
Q13	How do I wash columns?	8
Q14	How do I store columns?	
Q15	How long does a column last?	
Q16	What happens when a column deteriorates?	9
Q17	How can I confirm the deterioration of column?	
Q18	What should I pay attention to when I use semi-micro columns?	
Q19	What should I pay attention to when I use UHPLC columns?	
Q20	How much sample can be loaded on a preparative column?	
Q21	What should I pay attention to when I use both reversed phase and normal phase on the same instrument?	
Q22	What is the connection type?	10
Q23	Which detection methods should I use?	
Q24	What is the common pressure unit?	
Q25	What is dead volume?	
Q26	What is the difference between a column pre-filter and a guard column?	11
Q27	How do I pre-treat samples?	
Q28	How should I choose internal standards?	
• Troubleshooting		Page
T1	Poor peak shape	12
T2	Ghost peaks	13
T3	No peaks	
T4	Unstable base line	15
T5	Unstable retention time	
T6	Increased column pressure	16
T7	Unstable pump pressure	
T8	Poor resolution on C ₁₈ columns	
T9	No retention on reversed phase columns	
T10	Excessive analysis time on reversed phase columns	17
T11	Different separation performance compared to the past	
T12	Different separation performance with a new column	
T13	Colored elute from columns (colorless sample)	
T14	Air got inside the column (dried out)	

Q1. What is the pressure limit of COSMOSIL columns?

Column		Pressure Limit
Core-Shell Columns		60 MPa
2.5 μm , 3 μm Series		30 MPa
Chiral Columns		30 MPa
SFC Columns	I.D. 2.1–10.0 mm	30 MPa
	I.D. 20.0 mm or more	23 MPa
CNT Columns		15 MPa
Other Columns	Analysis Column (I.D. 1.0–7.5 mm)	20 MPa
	Preparative Column (I.D. 10.0 mm or more)	15 MPa

A large pressure change may deteriorate columns even within the recommended pressure range.

Q2. What is the flow rate limit?

You can raise the flow rate under the pressure limits stated in Q1.

We recommend using standard flow rate described on page 25. Generally, higher column pressure corresponds to shorter column lifetime.

Q3. What is the recommended pH range?

Column		Recommended pH Range
COSMOSIL / COSMOCORE Series (silica gel base)	COSMOSIL C ₁₈ -MS-II, 3C ₁₈ -EB	pH 2–10
	COSMOSIL C ₁₈ -AR-II	pH 1.5–7.5
	COSMOCORE C ₁₈	pH 1.5–10
	CHIRAL A, B, C	pH 2–9
	Other Columns	pH 2–7.5
COSMOGEL Series (polymer base)	COSMOGEL IEX Series	pH 2–12

The table above shows tolerant range for the packing material. Choose an appropriate pH for ionic samples.

Q4. What is the concentration of buffer and salt?

Column		Buffer and Salt Concentration
Reversed Phase, Normal Phase, HILIC		Buffer concentration: 0.005–0.1 mol/l Additive concentration (trifluoroacetic acid, formic acid or acetic acid) : 0.1–1.0%
Ion Exchange	COSMOGEL IEX Series	Buffer concentration: 0.02–0.05 mol/l Water miscible organic solvent concentration limit (e.g., methanol): 20% or less
Gel Filtration	COSMOSIL Diol Series	Buffer concentration: 0.5 mol/l or less Salt concentration: 0.5 mol/l or less
Hydrophobic Interaction	COSMOSIL HIC	Buffer concentration: 0.5 mol/l or less Salt concentration: 2 mol/l or less
SFC		Acidic compounds: 0.1% TFA, 0.1% acetic acid, 0.1% formic acid Basic compounds: 0.1% diethylamine

Caution:

- Insoluble compounds may clog columns. Filter buffers and salt solutions before using.
- Deposition of salt during analysis may damage columns or instruments. Use an appropriate buffer concentration so that salt does not precipitate.
- Salt often precipitates when the organic solvent is mixed with the aqueous solution. Be careful when mixing mobile phases.
- After using a mobile phase that contains organic solvent, replace with salt-free mobile phase before using a mobile phase with salt of the same aqueous/organic ratio. Likewise, after using a salt-containing mobile phase, wash with a salt-free solution of the same aqueous/organic ratio before using other mobile phases.

Q5. How do I prepare the mobile phase?

Please refer to page 23

Caution:

1. Prepare mobile phase consistently each time because concentration and pH may affect separation performance.
2. Degas the solvent after mixing.

Q6. What solvent grade should I use for the mobile phase?

We recommend using HPLC grade solvents.

GR grade solvents are not suitable for gradient analysis or micro-scale analysis because they contain impurities that have ultraviolet absorption, causing unstable baseline or inaccurate detection. This is especially problematic in the short wavelength range (210–220nm). GR grade solvents with antioxidants (e.g., tetrahydrofuran, chloroform) may produce ghost peaks. GR grade trifluoroacetic acid may be chemically unstable and is not recommended for HPLC.

Q7. Should I use acetonitrile or methanol for the mobile phase?

The table below shows some differences between acetonitrile and methanol when used for HPLC mobile phases.

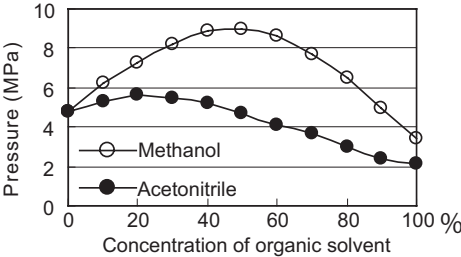
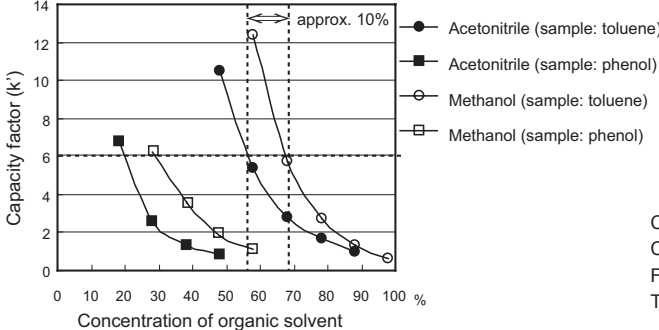
	Acetonitrile	Methanol
Pressure	 <p>Column 5C₁₈-MS-II Column size 4.6 mm I.D. x 150 mm Flow rate 1.0ml/min Temperature 30°C</p> <p>Backpressure differs depending on species of organic solvents and mixing ratio. The backpressure of acetonitrile is lower than that of methanol at the same concentration.</p>	
Elution Strength	 <p>Column 5C₁₈-MS-II Column size 4.6mm I.D.-150mm Flow rate 1.0ml/min Temperature 30°C</p> <p>The elution strength of acetonitrile/water is stronger than that of methanol/water at the same concentration. Within the range of about 30–80% organic solvent, the elution strength of acetonitrile/water is almost equivalent to that of methanol/water with about 10% higher concentration (e.g., acetonitrile : water = 60 : 40 → methanol : water = 70 : 30)</p>	
Absorbance	Acetonitrile has a lower UV absorbance in far UV region (less than 250 nm).	Methanol has a higher UV absorbance than acetonitrile in far UV region (less than 250 nm).
Degas of Mobile Phase	When acetonitrile is mixed with water, it is endothermic. It is difficult to degas.	When methanol is mixed with water, it is exothermic. It is easy to degas.

Q8. Which mobile phase can be used for LC/MS or ELSD detectors?

Volatile solvents should be used for LC/MS and ELSD. Phosphoric acid buffers cannot be used.

Reagent	Examples of usable solvents / additives
Solvent	Methanol, ethanol, acetonitrile, water
pH Adjusting Reagent	Acetic acid, formic acid, trifluoroacetic acid, ammonia solution, ammonium acetate, ammonium formate
Ion-Pairing Reagent	Dibutylamine, triethylamine

A small amount of non-volatile solvent, such as DMSO (dimethylsulfoxide) or DMF (dimethylformamide) can be used if they are mixed with methanol or acetonitrile. However, if the concentration becomes higher, detection sensitivity may decrease.

Q9. What should I pay attention to when using ion-pairing reagents?

- Concentration of ion-pairing reagent should be 5–10 mmol/l.
- Use mobile phase of pH 7 for acidic ion-pairing reagents and pH 2.5 for basic ion-pairing reagents.
- Thoroughly equilibrate column before use.

Notes:

1. Higher ion pair concentration will result in longer retention time.
2. Adjust pH of mobile phase so that the sample is well ionized.
3. Longer equilibration time is necessary compared to mobile phases without ion-pairing reagents.
4. Use a column exclusively for ion-pairing reagents, as it is difficult to eliminate them from the column.

Q10. What flow direction should I use for the mobile phase?

Pump mobile phase in the direction specified on the column label.

Pumping mobile phase in the reverse direction may deteriorate the packing material and decrease theoretical plates. Furthermore, impurities previously adsorbed on the column tip may loosen, causing noise and contaminated detector and tubing.

Q11. What is the recommended column oven temperature?

The maximum temperature is 60°C, but the recommended temperature range is 20–50°C. For SFC columns, keep the temperature below 50°C.

Caution:

1. Operating at high temperature under alkaline or acidic conditions may shorten column lifetime.
2. Maintain constant temperature during analysis as column temperature affects retention time. Generally, higher temperature lowers column pressure and shortens retention time.

Q12. What is the shipping solvent?

It depends on the column type. Please refer to the inspection report inside each column box.

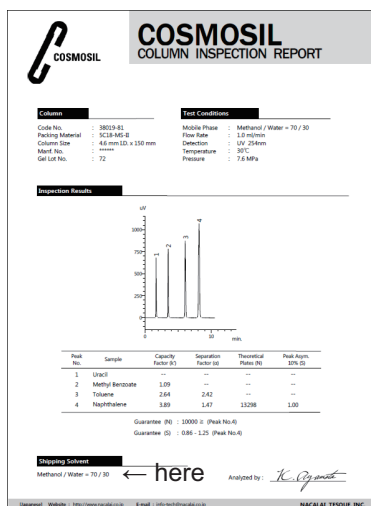

Q13. How do I wash columns?

1. Eliminate buffer, salt or acid from the column:

Wash the column with the current mobile phase without buffer, salt or acid for 10–15 min.

(E.g., for a mobile phase of methanol : 20 mmol/l phosphoric acid buffer = 50 : 50, wash with methanol : water = 50 : 50)

If the ratio of organic solvent and water is changed, salt may precipitate.

2. Wash impurities in a column to achieve a stable base line:

Use a solvent with strong elution properties in which the sample dissolves well.

Type	Usable Solvent / Additive
Reversed Phase	(1) Sample is not protein Methanol and/or tetrahydrofuran Cleaning Solution Kit for Reversed Phase HPLC Columns (Product No. 08966-30) (2) Sample is protein 50–70% acetonitrile in water containing 0.1% trifluoroacetic acid. Caution: Some proteins may precipitate when concentration of organic solvent is high.
Normal Phase	Methanol, tetrahydrofuran, ethanol
Columns for Fullerenes eparation	1,2,4-trichlorobenzene and others
Sugar-D, NH ₂ , HILIC	Acetonitrile : water = 50 : 50 * Sugar-D and HILIC can be washed with 100% water.
SFC	After completing analysis, wash the column with acid- and base-free mobile phase first, then with methanol or ethanol. Store the column with caps tightly plugged.

Do not use alkaline solutions (pH 7.5 or higher), as they dissolve silica gel. Do not use strongly acidic solutions (pH 1.5 or lower), as they may cleave the bonded phase.

3. Eliminate impurities clogging the column inlet: Pump solvent through in the reverse direction at half the flow rate of regular analysis.

Caution:

Disconnect column from the detector during washing.

Doing this frequently may disrupt the packing and damage the column. Filter samples and use a guard column to prevent problems like this.

4. If column pressure is high, please refer to page 29.

Q14. How do I store columns?

1. Short-term

Wash the column with the current mobile phase without buffer, salt or acid for 10–15 min. (E.g., for a mobile phase of methanol : 20 mmol/l phosphoric acid buffer = 50 : 50, wash with methanol : water = 50 : 50)

COSMOGEL IEX can be stored with a 20–50 mmol/L buffer solution (pH 4.5–9.5).

2. Long-term (one month or longer)

In addition to the above, replace solvent with the following to avoid fungus, drying, and/or deterioration of column.

Column	Recommended Storage Solvents
Reversed Phase	Storage Solution for Reversed Phase HPLC Columns (Product No. 08967-20) Methanol : water = 70 : 30, Acetonitrile : water = 70 : 30
Normal Phase	Halogen- and acid-free organic solvent (hexane : ethanol = 90 : 10)
Ion Exchange Gel Permeation Hydrophobic Interaction	0.05% sodium azide solution
Column for Fullerene Separaton	Toluene
Sugar-D, NH ₂ , HILIC	Acetonitrile : water = 70 : 30
SFC	Methanol or ethanol

Store tightly plugged columns in a cool, dark place where they will not fall or be bumped.

Q15. How long does a column last?

Column lifetime varies depending on the operation conditions (sample, mobile phase, buffer, pH, temperature, etc.).

The most common cause of a short column lifetime is inadequate sample treatment. Please refer to page 31.

Q16. What happens when a column deteriorates?

Common symptoms of column deterioration include increased column pressure, decreased theoretical plates, shortened retention time, poor peak shape, and decreased resolution.

Please refer to page 12.

Q17. How can I confirm the deterioration of the column?

Test the column under the same conditions as the attached inspection report. Use the same instrument every time to record the performance of the column. Record standard values over time and change to a new column if they deviate significantly.

Value	Potential Causes of Deviation
Capacity Factor (k')	If the stationary phase is stripped, retention time may shorten.
Theoretical Plates (N)	May decrease due to adsorbed impurities or a disrupted packing bed.
Peak Asymmetry (S)	May deviate due to deterioration of packing material or adsorption of impurities.
Pressure	May increase due to clogging of column filter, sample adsorption to packing material, compression of packing material, and other causes.

Q18. What should I pay attention to when I use semi-micro columns?

Use an injector, tubing and detector cell designed for semi-micro columns.

Confirm that the mobile phase flow rate is proportional to the column's cross-sectional area. For more information, please refer to page 25.

Q19. What should I pay attention to when I use UHPLC columns?

- Use a UHPLC instrument if available.
- For conventional HPLC instruments:
 - Shorten response of detector (e.g., 0.02 sec).
 - Use an injector, tubing and detector cell designed for UHPLC columns.
- Column pressure should be 30 MPa or less (60 MPa or less for COSMOCORE series).

Q20. How much sample can be loaded on a preparative column?

Sample loading capacity may differ depending on the peak resolution and solubility in the mobile phase. Optimize loading capacity using an analytical column, and determine loading capacity on a larger column in proportion to cross-sectional area.

For scaling up from an analytical column to preparative separation, please refer to page 25.

Q21. What should I pay attention to when I use both reversed phase and normal phase on the same instrument?

When switching between normal and reversed phase, replace the mobile phase with a solvent in which both mobile phases are miscible, such as ethanol, then replace with the new mobile phase.

Mobile phases for reversed phase (e.g., methanol, water) and normal phase (e.g., hexane) cannot be mixed.

Q22. What is the connection type?

COSMOSIL, COSMOGEL and COSMOCORE use Waters-type connectors. COSMOCORE uses the Waters® UHPLC connector, and COSMOSIL and COSMOGEL use the conventional Waters HPLC connector.

Waters-type connectors can be connected to most instruments, but please confirm with the manufacturer before using.

Q23. Which detection methods should I use?

Selection of a detector depends on the sample and the purpose of the experiment.

Detector	Description
Ultraviolet-Visible (UV-Vis) Detector	<p>[Detection] Absorbance</p> <p>[Sample] High sensitivity for compounds that have UV absorbance. Cannot be used for compounds that do not have UV absorbance.</p> <p>[Features] Easy, widely used</p>
Fluorescence Detector (FLD)	<p>[Detection] Fluorescence</p> <p>[Sample] Fluorescent samples</p> <p>[Features] For samples that have little or no UV absorbance. High detection sensitivity enables trace component analysis.</p>
Refractive Index (RI) Detector	<p>[Detection] Difference in index of refraction between sample and mobile phase</p> <p>[Sample] All samples</p> <p>[Features] For samples that have little or no UV absorbance (e.g., saccharides, alcohols, amino acids). Its disadvantages include sensitivity to change in temperature, mobile phase and flow rate.</p>
Electrochemical Detector (ECD)	<p>[Detection] Electrochemically active compounds</p>
Evaporative Light Scattering Detector (ELSD)	<p>[Detection] Scattered light of particulated target compound after evaporating mobile phase</p> <p>[Sample] Samples that have little or no UV absorbance (e.g., saccharides, alcohols, amino acids).</p> <p>[Features] High versatility, but not compatible with low-boiling compounds.</p>
Mass Spectrometric (MS) Detector	<p>[Features] Can acquire MS data for separated components for qualitative analysis. Compatible mobile phases are limited.</p>

Q24. What is the common pressure unit?

The most common unit of pressure is the SI unit, MPa.

Old instruments sometimes have different units (conversion: 1 MPa = 10.197 kgf/cm² = 145.0 psi = 10 bar).

Q25. What is dead volume?

Dead volume is the flow path volume from injector to detector that does not contribute to separation.

If dead volume is large, sample may spread and have poor peak shape. Choose proper injector, detector cell, tubing, and column inner diameter to minimize dead volume.

For appropriate inner diameters of tubing and detector cells, refer to page 25.

Q26. What is the difference between a column pre-filter and a guard column?

(1) Column pre-filter (④)

Connect between pump and injector to eliminate solid impurities in mobile phase.

(2) Guard column (⑥)

Connect between injector and analytical column to protect the analytical column from impurities and adsorbing compounds in sample. Please refer to page 37.

Schematic Diagram of HPLC

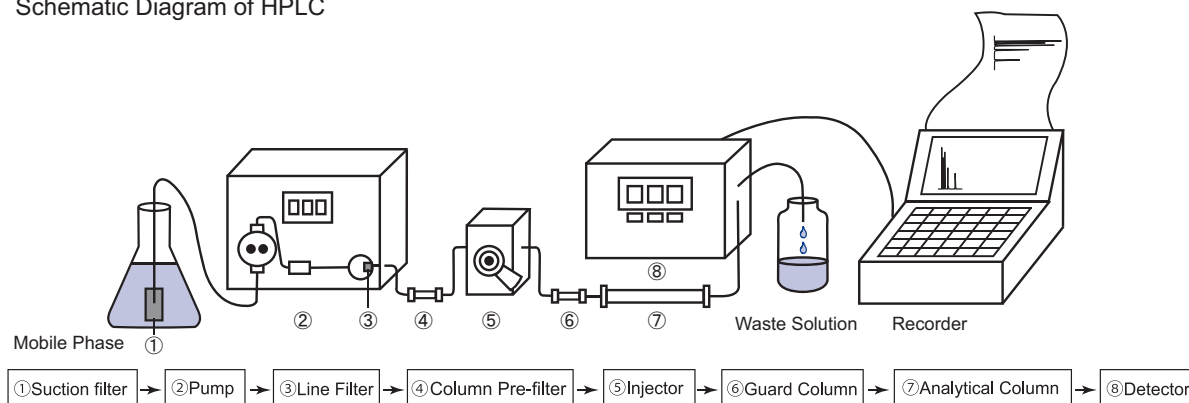

Q27. How do I pre-treat samples?

Please refer to page 31.

Q28. How should I choose internal standards?

Ideal internal standards have the following attributes:

- The peak of the internal standard is near target compound peaks, but does not overlap.
- Does not produce tailing peaks or adsorb to packing material.
- Easy to procure at a low price.
- Has good chemical stability.

Methyl to Butyl *p*-Hydroxybenzoate are widely used in the Japanese Pharmacopoeia.

T1. Poor peak shape

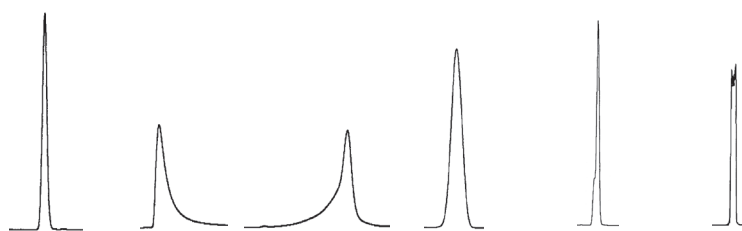

Normal Peak Tailing Peak Fronting Peak Broad Peak Peak Spike Peak Splitting

Symptom	Cause	Solution
Particular sample is tailing	Undesirable ion exchange interaction between basic compounds and packing material.	Use a column with fewer residual silanols (3C ₁₈ -EB or 5C ₁₈ -MS-II), or add 0.1-1% acid to mobile phase.
	Undesirable coordinate interaction between metal coordination compound and packing material.	Add 5 mmol/l of di-sodium dihydrogen ethylenediaminetetraacetate dihydrate (EDTA · 2Na) to mobile phase.
	Undesirable hydrogen bonding interaction between sample and packing material.	Change the organic solvent (e.g., acetonitrile to methanol).
All samples are tailing	Voids in packing material or column deterioration.	Replace the column.
	(If the tailing does not improve after replacing the column) Sample is dispersing inside the column.	Reduce dead volume (refer to Q25 on page 10 for more information on dead volume).
Fronting	Injection of large volume of sample solvent that is significantly different in elution properties or pH compared to mobile phase.	Dissolve sample in mobile phase. If the sample does not dissolve, dissolve in a soluble solvent first, then dilute with mobile phase.
		Reduce injection volume to 1/2-1/10. Caution: Spikes or peak broadening may also occur.
Broad peaks (1) Sample has high molecular weight (MW: 2,000 or greater).	Proteins with high molecular weight cannot access pores of packing material.	Use wide pore (pore size: 300 Å) column for reversed phase chromatography, COSMOSIL Protein-R. Please see web or catalog for more information.
	Sample volume is too large.	Reduce injection volume to 1/2-1/10. Caution: Tailing peaks may also occur.
	If a particular sample has a broad peak, the compound may be adsorbed to the packing material.	Use COSMOSIL Protein-R for a high recovery rate. Please see web or catalog for more information.
	If all samples have broad peaks, the column may have deteriorated.	Replace the column.
	Concentration of ammonium sulfate in sample solution is too low on hydrophobic chromatography (HIC).	Adjust concentration of ammonium sulfate to 1 mol/l or greater.

Symptom	Cause	Solution
Broad peaks (2) Sample has low molecular weight (MW: 2,000 or less).	Sample volume is too large.	Reduce sample amount from 1/2 to 1/10. Caution: Tailing peaks may occur instead of broad peaks.
	If a particular sample has a broad peak, the compound may be adsorbed to the packing material.	Replace with a column that has a different packing material. (COSMOSIL 3C ₁₈ -EB and 5C ₁₈ -MS-II are recommended for basic samples. Please see web or catalog for more information.)
	If all samples have broad peaks, the column may have deteriorated.	Replace the column.
Peak spikes or peak splitting occur for certain samples.	More than 2 samples are contained in the peak, and slightly separated.	Find the conditions that separate the two samples.
	Mobile phase and sample solvent are significantly different in their separation properties.	Dissolve sample in mobile phase. If sample does not dissolve, dissolve sample in soluble solvent, then dilute with the mobile phase. Reduce injection volume to 1/2 to 1/10.
	Mixed dissociated and non-dissociated ionic sample.	Adjust pH of mobile phase to pKa ± 2 or more of the ionic sample.
Peak spikes or peak splitting occur for all samples	Mobile phase and sample solvent are significantly different in their separation properties.	Dissolve sample in mobile phase. If sample does not dissolve, dissolve sample in soluble solvent, then dilute with the mobile phase. Reduce injection volume to 1/2 to 1/10.
	The column may have deteriorated.	Replace the column.

T2. Ghost peaks

Separation Mode	Cause	Solution
<Reversed Phase Chromatography> Gradient elution	Peaks from water impurities	Use new HPLC-grade distilled water.
		Use a pre-column. Please refer to page 36 for more information.
<Reversed Phase Chromatography> Protein samples	Sample may be adsorb to the column, and elute on the next analysis.	Wash column. Please refer to page 8 for more information on washing methods. COSMOSIL Protein-R, which has high recovery rates for protein separations, is recommended.
<All Separation Modes> Sample solvent and mobile phase are significantly different.	Sample solvent has peaks.	Dissolve sample in mobile phase. If sample does not dissolve, dissolve sample in a soluble solvent, then dilute with the mobile phase.
<All Separation Modes> Peaks in blank analysis (Peak area decreases with each injection.)	Injector is contaminated.	Wash by injecting with a syringe 20 ml of solvent (e.g., methanol) that can dissolve the contaminants.
	Micro-syringe is contaminated.	Wash with solvent (e.g., methanol, chloroform or water) to dissolve the pollutants. Ultrasonic cleaning is effective.
Others	Contamination or deterioration of samples	Prepare the sample again.
	Stabilizers in the mobile phase	Use HPLC-grade solvent without stabilizers.

T3. No peaks

Confirm the cause by checking t_0 (peak of non-retained compound) first.

Analysis result of t_0	Cause
t_0 is not detected (no peak).	Detector may be defective.
Retention time of t_0 has shifted.	Pump may be defective.
Retention time of t_0 is the same as usual.	Column may be defective.

T3. No peaks (cont.)

• Solution for Each Column Type

Column Type	Cause	Solution
Reversed phase column	Sample is still in the column due to its high hydrophobicity.	Increase elution strength of mobile phase until the sample elutes. For example: 1. Increase concentration of methanol or acetonitrile (maximum 100%). 2. If the sample still does not elute, add 10–30% of stronger organic solvent (e.g., tetrahydrofuran or chloroform) in methanol or acetonitrile (e.g., tetrahydrofuran : methanol = 30 : 70).
	Metal coordination or basic compounds may be adsorbed to the column.	Basic compounds may interact with residual silanols in the packing material. Use COSMOSIL 3C ₁₈ -EB or 5C ₁₈ -MS-II, which have fewer residual silanols, or add 0.1–1% acid (e.g., trifluoroacetic acid, acetic acid) to the mobile phase.
		Metal coordination compounds may interact with a small amount of metal in the packing material. Add 5 mmol/l di-sodium dihydrogen ethylenediaminetetraacetate dihydrate (EDTA · 2Na) to the mobile phase.
Normal phase column	Sample is strongly hydrophilic and is still in the column.	Increase elution strength of mobile phase until the sample elutes. Replace with strongly eluting solvent (e.g., ethanol) or increase its concentration.
	Metal coordination or basic compounds may be adsorbed to the column.	Add 0.1–1% acid (e.g., trifluoroacetic acid, acetic acid) to the mobile phase.
Columns for saccharide analysis (Sugar-D, NH ₂ -MS) or hydrophilic column (HILIC)	(COSMOSIL 5NH ₂ -MS) Sample is adsorbed to amino groups.	Use COSMOSIL Sugar-D, which prevents sample adsorption and has high recovery rates.
	Sample is strongly hydrophilic and is still in the column.	Increase concentration of water in mobile phase until the sample elutes. COSMOSIL Sugar-D and COSMOSIL HILIC are compatible with 100% aqueous mobile phase. COSMOSIL 5NH ₂ -MS is compatible with up to 50% water (e.g., acetonitrile : water = 50 : 50).
Gel filtration column (Diol series)	Sample has ionic effect on silanol group.	To increase ionic strength of mobile phase, add approx. 0.3 mol/l of salt (e.g., sodium chloride). Adjust mobile phase pH to 5.5 or less to prevent ionic interaction.
	Sample may have adsorbed to stationary phase due to hydrophobic interaction.	Add 10–50% organic solvent (e.g., acetonitrile) to mobile phase.
Hydrophobic interaction chromatography (HIC) column	Hydrophobicity of sample is too high.	Add 5% organic solvent (e.g., methanol or acetonitrile).
	Ammonium sulfate may have precipitated in sample before injection.	Decrease concentration of ammonium sulfate to 0.5 mol/l or less, until no precipitation is observed.

• Defective Pump

Cause	Solution
Bubbles generated in the pump	Degas. Please refer to T7 on page 16.
Solvent leaking	Tighten connectors and/or replace tubing.

• Defective Detector

Cause	Solution
Detector is not connected correctly.	Follow the detector user manual to connect correctly.
Defective signal from the detector	Contact detector manufacturer.
UV absorption range is not suitable for your sample.	Analyze at suitable UV absorption wavelength for the sample. If the sample has little or no UV absorption, use refractive index (RI) detector or evaporative light scattering detector (ELSD), or label the sample.

T4. Unstable baseline

Cause	Solution
Sample may be adsorb to the column, and elute on the next analysis.	Wash with strongly eluting solvents. Please refer to Q13 on page 8.
The bonded phases of COSMOSIL PE-MS, π NAP, PYE, NPE, PBr, and Cholester have UV absorption, and slight shedding may cause baseline noise.	Wash with strongly eluting solvents. Please refer to Q13 on page 8. A small amount of bonded phase shedding does not significantly affect column performance.
Sudden changes in the pump pressure may create bubbles.	Degas. Please refer to T7 on page 16.
When using refractive index (RI) detector	
Large temperature variation	Use a thermostatic bath to keep a constant temperature. Be aware of air conditioners or other wind sources blowing on the RI detector or tubing. Cover equipment and tubing for insulation.
Residual gas in mobile phase	Degas mobile phase (by ultrasonic waves or aspirator).
Needle-like peaks from an ultraviolet-visible detector	
Bubbles in the column or detector	Increase pressure to remove bubbles by blocking outlet of the detector. Caution: Too much pressure may break the detector cell. If the problem persists, disconnect the column and flow a viscous solvent (e.g., 2-propanol) for 15 min.
Column temperature may be above or near the boiling point of the mobile phase, creating bubbles.	Analyze at suitable temperature. Generally, 20–50°C is suitable temperature for columns. To get the best results, analyze at least 20°C lower than the boiling point of the mobile phase (for methanol [boiling point: 64.7°C], analyze at 45°C or less).
When using ion-pair reagents or buffers.	
Inadequate equilibration of the column	Use longer equilibration time. When using ion-pair reagents or buffers, longer equilibration time is required compared to mobile phases without them.
Salt may precipitate in the mobile phase (the mobile phase reservoir may become cloudy).	(a) Decrease concentration of buffer. (e.g., 100 mmol/l → 20 mmol/l) (b) Replace with a different buffer solution. (e.g., phosphoric acid buffer → acetic acid buffer) (c) Reduce concentration of organic solvent. (e.g., acetonitrile : water = 70 : 30 → 50 : 50) (d) Replace with a different organic solvent. (e.g., acetonitrile → methanol)

T5. Unstable retention time

• Cause by Equipment

Equipment	Cause	Solution
Pump	Bubbles in the check valve of pump.	Degas. Please refer to T7 on page 16. Normal phase solvents have lower boiling point, so bubbles are easily created. Furthermore, its low viscosity prevents bubbles from eluting.
	Solvent leaking	Tighten the leaking part. If the problem is not resolved, replace it.
Thermostatic Bath (for adjusting temperature)	Column temperature may vary by season or the time of day (without the use of thermostatic bath or column oven).	Use thermostatic bath or column oven to keep a consistent column temperature. Set thermostatic bath or column oven to 5°C above room temperature when doing room temperature analyses to prevent temperature fluctuation.

● Cause by Columns

Column Type	Cause	Solution
Reversed Phase Columns	Inadequate column equilibration when using ion-pairing reagents.	Make equilibration time longer. When using ion-pairing reagents, longer equilibration time is often required.
	If 100% water is used as mobile phase on a C ₁₈ column, phase collapse may occur.	Use COSMOSIL C ₁₈ -PAQ, which is compatible with 100% aqueous mobile phases. To fix phase collapse, wash the column with high-organic solvents (e.g., methanol : water = 70 : 30).
Normal Phase Columns	A small amount of water in the organic solvent may affect retention time.	Remove water from mobile phase. If the sample solvent contains water, change the sample solvent or decrease the injection volume. If water is trapped in the column, wash with ethanol to recover.
Columns for Saccharide Analysis (Sugar-D, NH ₂ -MS) or Hydrophilic Chromatography column (HILIC)	A small amount of stationary phase has detached.	COSMOSIL Sugar-D and COSMOSIL HILIC can be recovered by washing with 100% water for 15 minutes. COSMOSIL 5NH ₂ -MS may be recovered by washing with 50% water (e.g., acetonitrile : water = 50 : 50) for 15 minutes.

T6. Increased column pressure

Please refer to page 29.

T7. Unstable pump pressure

Cause	Solution
Bubbles in the check valve of a pump.	Degas the check valve (open drain valve, and let mobile phase through) according to the pump's instructions. If the problem persists, wash check valve (e.g., ultrasonic cleaning in water).

Notes:

1. If the bubbles occur often in normal phase chromatography, connect pre-column to increase pressure, and let bubbles elute.
2. Degas mobile phase by ultrasonic waves or an aspirator.

T8. Poor resolution on C₁₈ columns

Solution	Features
Use a longer column	A longer column results in sharper peaks. The pressure will increase, and the retention time will be longer.
Change mobile phase condition (e.g., pH, type/concentration of organic solvent)	Knowledge of sample chemistry is required. Complicated conditions may lack reproducibility and are not recommended.
Use packing material with non-hydrophobic interactions.	Separate sample by molecular shape selectivity, π - π electron interactions, or others. Please refer to page 39 for more information on specialty columns.

T9. No retention on reversed phase columns

Solution	Features
Use ion-pairing reagents	Ion-pairing reagents enable separation by forming ion pairs with the sample to increase hydrophobicity. Therefore, it is not suitable for non-dissociating samples.
Use hydrophilic columns (HILIC). Alternatively, use a reversed phase column with better retention for polar compounds (such as COSMOSIL PBr).	Hydrophilic analytes are retained longer compared to C ₁₈ .

T10. Excessive retention on reversed phase columns

Solution	Features
Use gradient elution.	Gradient elution shortens analysis time by changing the organic solvent concentration during analysis. Disadvantages: need for a suitable instrument, increasing baseline, and the need for equilibration time between runs.
Use UHPLC Columns.	Please see our catalog or web site for details.
Change mobile phase conditions.	Problem may be solved by changing pH and/or type/concentration of organic solvent.
Use column with low hydrophobicity.	COSMOSIL CN-MS is recommended. Please see our catalog or web site for details.

T11. Different separation performance compared to the past

Symptom	Cause	Solution
Decreased theoretical plates	Natural deterioration of the packing material	No method to recover column
Decrease of retention time or separation	Impurities may be adsorbed to the packing material.	The column can be recovered by washing.
	Stationary phase shedding	No method to recover column

T12. Different separation performance with a new column

Cause	Solution																																						
Analytical conditions not suitable for sample.	Adjust pH of mobile phase to sample pKa ± 2 or greater. Use mobile phase with high repeatability.																																						
Column deteriorated	If the column deteriorates, retention time may decrease, and peak shape may change. Replace the column.																																						
Lot-to-lot variation	<p>Contact us with the column name, serial numbers, and present separation status.</p> <p>(a) Evaluate columns with 3 different packing material lots. We provide columns for method validation with 3 different packing material lots for the following products.</p> <table border="1"> <thead> <tr> <th>Product Name</th> <th>Product Number</th> <th>Column Size I.D. x Length (mm)</th> </tr> </thead> <tbody> <tr> <td rowspan="3">COSMOSIL 5C₁₈-MS-II</td> <td>38019-81</td> <td>4.6 x 150</td> </tr> <tr> <td>09397-73</td> <td>4.6 x 150 3 lots set</td> </tr> <tr> <td>38020-41</td> <td>4.6 x 250</td> </tr> <tr> <td rowspan="3">COSMOSIL 5C₁₈-AR-II</td> <td>38144-31</td> <td>4.6 x 150</td> </tr> <tr> <td>09396-83</td> <td>4.6 x 150 3 lots set</td> </tr> <tr> <td>38145-21</td> <td>4.6 x 250</td> </tr> <tr> <td rowspan="3">COSMOSIL 3C₁₈-EB</td> <td>09841-91</td> <td>4.6 x 75</td> </tr> <tr> <td>09842-81</td> <td>4.6 x 100</td> </tr> <tr> <td>09843-71</td> <td>4.6 x 150</td> </tr> <tr> <td rowspan="3">COSMOSIL Cholester</td> <td>05976-61</td> <td>4.6 x 150</td> </tr> <tr> <td>07970-03</td> <td>4.6 x 150 3 lots set</td> </tr> <tr> <td>05977-51</td> <td>4.6 x 250</td> </tr> <tr> <td rowspan="3">COSMOSIL HILIC</td> <td>07056-51</td> <td>4.6 x 150</td> </tr> <tr> <td>09385-23</td> <td>4.6 x 150 3 lots set</td> </tr> <tr> <td>07057-41</td> <td>4.6 x 250</td> </tr> </tbody> </table> <p>(b) Develop a robust analytical method that is less influenced by lot-to-lot variation.</p>	Product Name	Product Number	Column Size I.D. x Length (mm)	COSMOSIL 5C ₁₈ -MS-II	38019-81	4.6 x 150	09397-73	4.6 x 150 3 lots set	38020-41	4.6 x 250	COSMOSIL 5C ₁₈ -AR-II	38144-31	4.6 x 150	09396-83	4.6 x 150 3 lots set	38145-21	4.6 x 250	COSMOSIL 3C ₁₈ -EB	09841-91	4.6 x 75	09842-81	4.6 x 100	09843-71	4.6 x 150	COSMOSIL Cholester	05976-61	4.6 x 150	07970-03	4.6 x 150 3 lots set	05977-51	4.6 x 250	COSMOSIL HILIC	07056-51	4.6 x 150	09385-23	4.6 x 150 3 lots set	07057-41	4.6 x 250
Product Name	Product Number	Column Size I.D. x Length (mm)																																					
COSMOSIL 5C ₁₈ -MS-II	38019-81	4.6 x 150																																					
	09397-73	4.6 x 150 3 lots set																																					
	38020-41	4.6 x 250																																					
COSMOSIL 5C ₁₈ -AR-II	38144-31	4.6 x 150																																					
	09396-83	4.6 x 150 3 lots set																																					
	38145-21	4.6 x 250																																					
COSMOSIL 3C ₁₈ -EB	09841-91	4.6 x 75																																					
	09842-81	4.6 x 100																																					
	09843-71	4.6 x 150																																					
COSMOSIL Cholester	05976-61	4.6 x 150																																					
	07970-03	4.6 x 150 3 lots set																																					
	05977-51	4.6 x 250																																					
COSMOSIL HILIC	07056-51	4.6 x 150																																					
	09385-23	4.6 x 150 3 lots set																																					
	07057-41	4.6 x 250																																					
Column is not the cause (e.g., mobile phase, flow rate, temperature)	Use our FAQ and troubleshooting guide to find the cause.																																						

T13. Colored elute from columns (colorless sample)

Cause	Solution
Small amount of stationary phase shedding, impurities or previous samples.	Wash column with strongly eluting solvent (e.g., methanol), or use cleaning solution kit for reversed phase HPLC columns (product no. 08966-30).

A small amount of stationary phase shedding does not affect retention time.

T14. Air inside the column (dry column)

Flow solvent with low viscosity (e.g., methanol) through column at half of normal flow rate for 1 hour.

Store it tightly plugged in a cool, dark place.

2. Liquid Chromatography Basics

History of Liquid Chromatography

Liquid chromatography was invented by Mikhail S. Tswett (1906–1907), who separated leaf pigments into different colored bands using chalk powder (CaCO_3) as the adsorbent. Later in the 20th century, reversed phase chromatography, ion exchange chromatography, and size exclusion chromatography were developed. In 1971, J.J. Kirkland succeeded in the production of chemically bonded packing material for liquid chromatography, and contributed to establishing high-performance liquid chromatography, which has become an indispensable method of analysis.

HPLC Equipment

HPLC instrument components are connected as shown in Figure 1. Mobile phase flows from mobile phase reservoir to the pump, injector, column, detector, and lastly the waste solvent container. Samples are introduced into mobile phase through the injector and separated by the column. The chromatogram is drawn by the recorder, or recorded by a computer.

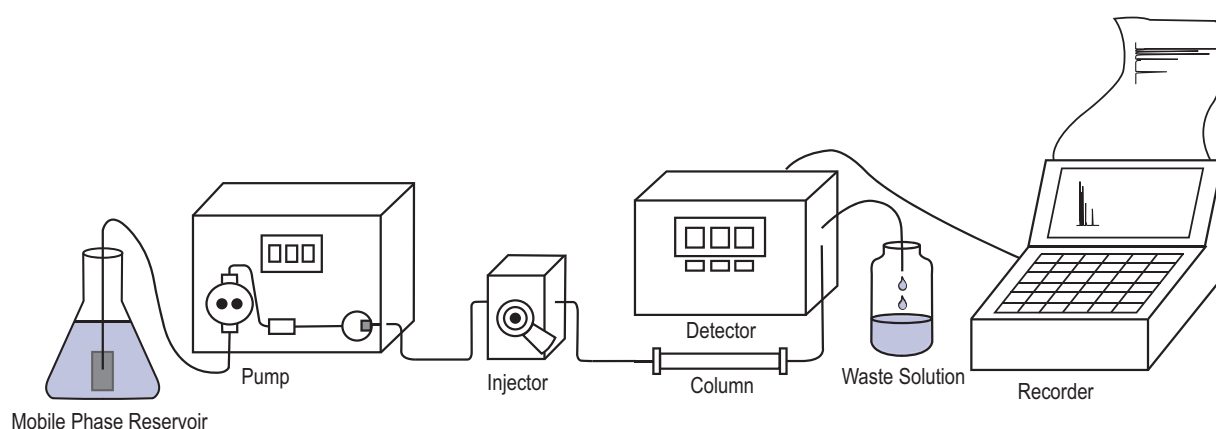

Figure 1. HPLC Equipment

- **Mobile Phase Reservoir**
Glass bottle or conical flask is used as a mobile phase reservoir. To avoid clogging from insoluble compounds in the mobile phase, a suction filter (or sinker) is attached to the inlet.
- **Pump**
Moves mobile phase at a consistent flow rate or pressure. Two pumps are required for gradient elution.
- **Injector**
Inject sample using a micro-syringe. Auto-injectors are widely used for automated sample injection.
- **Column**
Packing material is packed in a stainless steel or glass column. To avoid the elution of packing material, a frit ($2\ \mu\text{m}$) is put on each end of the column.
- **Column Thermostatic Oven**
Maintains a consistent temperature in the column. Temperature control is very important for reversed phase chromatography and ion exchange chromatography. It is generally desirable to keep the temperature variation within $\pm 0.5^\circ\text{C}$. Water and air circulators are widely used.
- **Detector**
Detects compounds eluted from the column, and sends the data to the recorder.
- **Recorder**
Processes the electronic signals from detector to draw chromatograms. Retention time, peak area, and theoretical plate numbers are automatically calculated.

Chromatogram

A chromatogram is a two-dimension diagram (Figure 2) that shows analyte concentration (detector intensity) vs. retention time. The chromatogram shows following data.

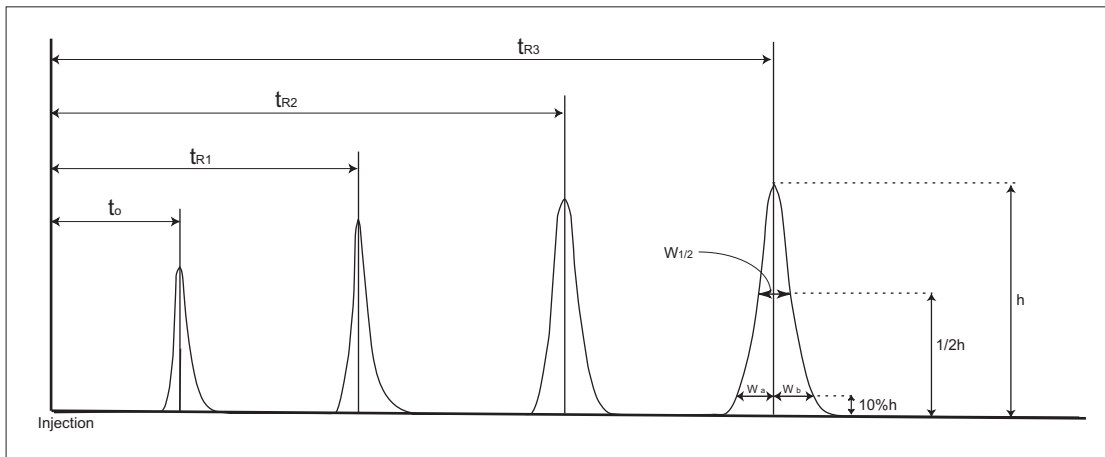

Figure 2. Chromatogram

(1) t_0 : Retention time of the mobile phase

The retention time of an unretained peak. Uracil is widely used in reversed phase chromatography as a t_0 marker.

(2) t_R : Retention time

Time from the the start of analysis to peak midpoint.

(3) h : Peak height

Distance from the peak top to the baseline.

(4) $W_{1/2}$: Peak half width

The peak width at half height

(5) k' : Capacity factor, retention ratio of each sample, $k' = (t_R - t_0)/t_0$

A higher ratio means longer retention. This value remains consistent under the same experimental conditions (packing material, mobile phase, and temperature).

(6) N : Theoretical plate number, $N = 5.54 (t_R/W_{1/2})^2$

A theoretical plate is an imaginary layer within a column that corresponds to a certain amount of separation performance. A higher theoretical plate number corresponds to better column efficiency. The plate number depends on the analyte, packing material, and experimental conditions.

(7) S : Peak asymmetry, $S = W_b/W_a$

W_a : Distance from the leading edge of the peak to the midpoint (measured at 10% of peak height)

W_b : Distance from the peak midpoint to the trailing edge (measured at 10% of peak height)

A peak asymmetry of $S = 1$ indicates a perfectly symmetrical peak, $S > 1$ indicates tailing, and $S < 1$ indicates leading. Tailing or leading occurs with deteriorated packing material, unsuitable experimental conditions, or overloading.

(8) α : Separation factor, $\alpha = k'_2/k'_1$ (k'_1 and k'_2 : capacity factor of peaks 1 and 2, with peak 2 eluted last)

The separation factor must be greater than 1 for separation. A higher value indicates greater distance between the peak midpoints.

(9) R_s (resolution) : Resolution, $R_s = \frac{\sqrt{N}}{4} \cdot \left(\frac{\alpha - 1}{\alpha} \right) \cdot \left(\frac{k'_2}{1 + k'_2} \right)$

The resolution (R_s) indicates how well two samples are separated. A value greater than 1.5 indicates baseline separation. If the value is smaller than 1.5, peaks may overlap significantly.

Features of Each Separation Mode of HPLC

Within HPLC, the following separation modes are commonly used.

• Normal Phase Chromatography

Adsorbent material such as silica gel or alumina is used as the packing material. Analytes are separated by the difference in adsorptive forces to the packing material, resulting in each eluting at a different speed. Analytes that interact more strongly with the packing material move at a slower rate.

• Reversed Phase Chromatography

Analytes are distributed between the polar mobile phase and non-polar stationary phase, and separated by their difference in affinity for the two phases. If an analyte has greater affinity for the stationary phase, it elutes later. Non-polar packing materials, such as octadecyl group- and octyl group-bonded silica gels, are widely used, as they are stable against heat and hydrolysis within a certain pH and temperature range. Separation behavior is influenced by the type of stationary phase, carbon ratio, endcapping treatment, etc.

• Ion-Exchange Chromatography

Charged functional groups are bonded to the solid support to separate ionic solutes with counter ions. Analytes are separated by their difference in the affinity for the stationary phase. Dextran, cellulose, and polystyrene are commonly used as the packing materials. Typical functional groups are sulfopropyl (SP) and carboxymethyl (CM) for cationic exchange, and diethylaminoethyl (DEAE) and quaternary ammonium (QA) for anionic exchange. Separation performance depends on the type and density of the functional groups.

• Size Exclusion Chromatography

Analytes are separated by their molecular size. Analyte smaller than the pores elute slowly, whereas larger analytes are excluded from the pores and elute quickly. This mode is mainly used for separation of high-molecular weight polymers (MW 2,000 and greater). Organic gels (such as dextran and polyacrylamide) and inorganic gels (such as silica gel and glass) are used as packing materials.

Separation Mechanism of HPLC

The most common mode, reversed phase, is used as an example here. Mixed samples are injected into a column. The less hydrophobic analyte (A) distributes in the polar mobile phase and move faster down the column. Conversely, the more hydrophobic analyte (B) distributes in the non-polar stationary phase for a longer time and moves more slowly through the column. In general, analytes elute in order from polar to non-polar.

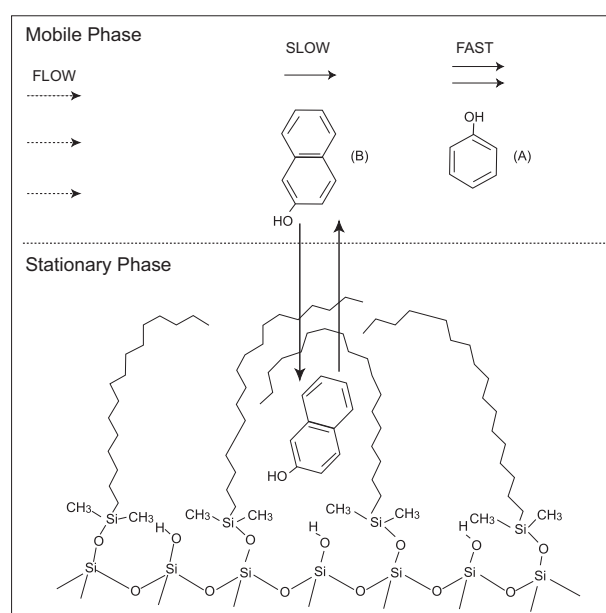

Figure 3. Separation Mechanism

Mobile Phase Solvent

Important considerations for HPLC mobile phases are shown below.

1. High solubility for the sample components
2. All solvents in the MP are miscible with each other
3. Low detection interference
4. Low viscosity
5. Much higher boiling point than the column oven temperature
6. Low toxicity/flammability
7. Low price
8. HPLC grade or finely filtered

Below is a selection guide for mobile phases by separation mode.

● Normal Phase Chromatography

Generally, a polar solvent is mixed with a nonpolar solvent. The separation factor is adjusted by changing the solvent ratio. Please consider the polarity and the solubility of solvent. Toluene, hexane, chloroform, ethyl acetate, and ethanol are mainly used.

● Reversed Phase Chromatography

Water, methanol, acetonitrile, and tetrahydrofuran are mainly used. Separation is adjusted by changing the ratios of these solvents. When using silica-based columns for ionic analytes, it is desirable to adjust the pH, keeping it between 2 and 7.5. Generally, silica-based columns are not stable outside of this range due to cleavage of the bonded groups at pH < 2 and the dissolution of the silica support at pH > 7.5. Filtered phosphoric acid or acetic acid buffer solutions are suitable for pH control.

● Ion-Exchange Chromatography

Add buffer solution in water and adjust separation with salt concentration (ionic strength) and pH. Higher salt concentrations will result in faster elution. Lower pH decreases retention time with anion exchange, and increases retention time with cation exchange. Cationic buffer solutions, such as ammonia and amines, are used for anion exchange; and anionic buffer solutions, such as acetic acid, formic acid, and citric acid salts, are used for cation exchange.

● Size Exclusion Chromatography

Generally, a single solvent is used as the mobile phase, and it is not changed to adjust the separation factor. Tetrahydrofuran, chloroform, toluene and dimethylformamide are commonly used in non-aqueous mode, and aqueous buffer solutions are used for aqueous mode. Adjust pH and ionic strength to prevent adsorption and other undesired interactions.

Quantitative Analysis

The absolute calibration curve method or internal standard method is used to calculate the amount or concentration of solute by peak area.

● Absolute Calibration Curve Method

1. Prepare the standard solutions in 3–4 different concentrations.
2. Inject the same volume of each standard solution, record chromatogram, and measure peak area.
3. Prepare a calibration curve by plotting the amounts of the standard on the x-axis and the peak areas on the y-axis. The calibration curve is usually a straight line through the origin.
4. Inject sample under the same conditions as the standards, and record a chromatogram. Measure the peak area (y) and use the calibration curve to determine the sample amounts.

This method should be performed exactly under a given condition. This method is also called external standard method.

● Internal Standard Method

1. Prepare 3–4 known concentration^{*1} ratios of the standards and samples^{*2}.
2. Inject a constant volume of each concentration, record chromatogram, and measure peak areas.
3. Prepare a calibration curve (as shown on fig. 5) by plotting M_x/M_s vs. A_x/A_s ratios. M_x is the amount of the sample injected, and M_s is the amount of the standard. A_x is the peak area of the sample, and A_s is the peak area of the standard. The calibration curve is usually a straight line through the origin.
4. Prepare a the test solution containing a known amount of the internal standard and an unknown amount of sample^{*3}. Perform the experiment under the same conditions as for obtaining the calibration curve.
5. Use the calibration curve to determine the unknown sample amount.

*1 If the calibration curve is confirmed beforehand to be a straight line through the origin, the calibration curve may be plotted with A_x/A_s determined by one point of concentration of injected unknown sample.

*2 The internal standard should have similar chemical characters as the sample while completely separated from it.

*3 When the internal standard is added to the test solution, make sure that chemical reactions (e.g., precipitation) do not occur.

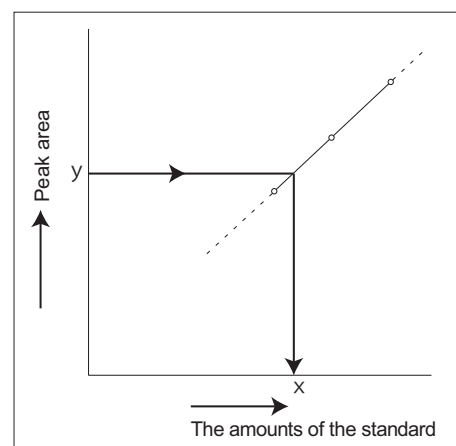

Figure 4. Absolute calibration curve

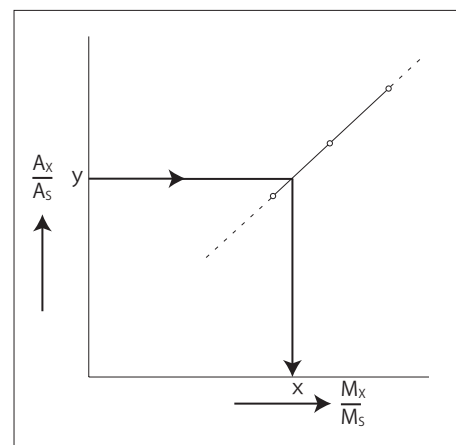

Figure 5. Calibration curve of internal standard method

3. Technical Information

(1) Preparation of Mobile Phase for HPLC

1) Organic Solvent / Aqueous Mixed Mobile Phase

(Example) Methanol : Water = 70 : 30 1L

Prepare mobile phase by volume ratio.

1. Measure 700 ml of methanol in a measuring cylinder.
2. Measure 300 ml of distilled water in a measuring cylinder.
3. Mix 1 and 2 thoroughly and degas.

Note: The better approach is to measure by mass rather than volumetrically. This is more precise in general and reduces the effect of temperature on measurement.

Composition table for 1 L of mobile phase (methanol / water)

Methanol / Water	Methanol (g)	Distilled Water (g)
90 : 10 (v/v)	711.9	99.8
80 : 20 (v/v)	632.8	199.6
70 : 30 (v/v)	553.7	299.5
60 : 40 (v/v)	474.6	399.3
50 : 50 (v/v)	395.5	499.1
40 : 60 (v/v)	316.4	598.9
30 : 70 (v/v)	237.3	698.7
20 : 80 (v/v)	158.2	798.6
10 : 90 (v/v)	79.1	898.4

Composition table for 1 L of mobile phase (acetonitrile / water)

Acetonitrile / Water	Acetonitrile (g)	Distilled Water (g)
90 : 10 (v/v)	707.4	99.8
80 : 20 (v/v)	628.8	199.6
70 : 30 (v/v)	550.2	299.5
60 : 40 (v/v)	471.6	399.3
50 : 50 (v/v)	393.0	499.1
40 : 60 (v/v)	314.4	598.9
30 : 70 (v/v)	235.8	698.7
20 : 80 (v/v)	157.2	798.6
10 : 90 (v/v)	78.6	898.4

Caution: Methanol and acetonitrile are hazardous substances. Always process in a laboratory hood, and wear eye protection and a mask.

Influence of mobile phase composition on retention time.

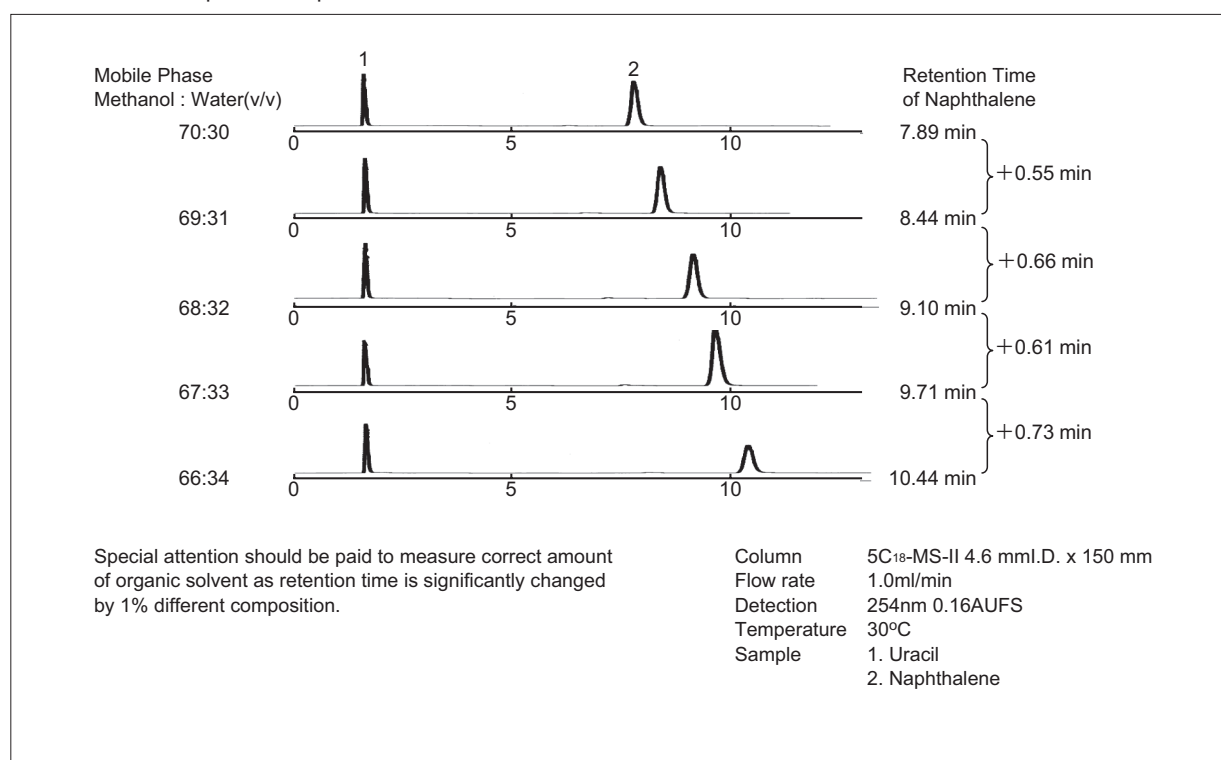

2) Organic Solvent / Buffer Mixed Mobile Phase

(Example 1) Preparation of 20 mmol/l phosphate buffer (pH 2.5)

1. Prepare 20 mmol/l sodium dihydrogenphosphate solution: Dissolve 2.40 g of anhydrous sodium dihydrogenphosphate (Product No. 31720-65) in distilled water to make a 1 L solution.
2. Prepare 20 mmol/l phosphoric acid solution: Dissolve 2.31 g of 85% phosphoric acid (Product No. 08964-92) in distilled water to make a 1 L solution.
3. Adjust the pH to 2.5 by mixing the two solutions.
4. Filter to remove insoluble substances (0.45 μm or smaller pore size is recommended). Unfiltered solutions may clog pump and columns.
5. When mixing with organic solvent, mix by volume ratio.
Solids may precipitate after mixing. Please ensure that the buffer is soluble in the final mobile phase.

(Example 2) Preparation of 20 mmol/l phosphate buffer (pH 7.0)

1. Prepare 20 mmol/l sodium dihydrogenphosphate solution: Dissolve 2.40 g of anhydrous sodium dihydrogenphosphate (Product No. 31720-65) in distilled water to make 1L solution.)
2. Prepare 20 mmol/l disodium hydrogenphosphate solution: Dissolve 2.84 g of disodium hydrogenphosphate, (Product No. 31801-05) in distilled water to make a 1 L solution.
3. Adjust the pH to 7 by mixing the two solutions.
4. Filter to remove insoluble substances (0.45 μm or smaller pore size is recommended). Unfiltered solutions may clog pump and columns.
5. When mixing with organic solvent, mix by volume ratio.
Solids may precipitate after mixing. Please ensure that the buffer is soluble in the final mobile phase.

(Example 3) Preparation of 5 mmol/l Sodium 1-hexanesulfonate, 20 mmol/l phosphate buffer (pH 2.5)

1. Prepare 5 mmol/l sodium 1-hexanesulfonate, 20 mmol/l sodium dihydrogenphosphate solution: Dissolve 10 ml of 0.5 M sodium 1-hexanesulfonate (Product No. 31532-06) and 2.40 g of anhydrous sodium dihydrogenphosphate (Product No. 31720-65) in distilled water to make a 1 L solution.
2. Prepare 5 mmol/l sodium 1-hexanesulfonate, 20 mmol/l phosphoric acid solution: Dissolve 10 ml of 0.5 M sodium 1-hexanesulfonate (Product No. 31532-06) and 2.31g of 85% phosphoric acid (Product No. 08964-92) in distilled water to make a 1 L solution.
3. Adjust the pH to 2.5 by mixing the two solutions.
4. Filter to remove insoluble substances (0.45 μm or smaller pore size is recommended).
Unfiltered solutions may clog pump and columns.
5. When mixing with organic solvent, mix by volume ratio.
Solids may precipitate after mixing. Please ensure that the buffer is soluble in the final mobile phase.

1) Inner Diameter of Column

Introduction

The table below shows general parameters for 1.0 mm to 50 mm I.D. COSMOSIL columns. It may help to scale up or down from the most commonly used 4.6 mm I.D. columns, depending on your application.

Inner Diameter (mm I.D.)	1.0	2.0	3.0	4.6	10	20	28	50
Flow Rate (ml/min)	0.05	0.2	0.4	1.0	5.0	19	37	70
Detector Cell, Injector	Semi-Micro		Analytical			Preparative		
Tubing Internal Diameter (mm)	0.05	0.1	0.2-0.3			1.0		
Application	LC-MS Solvent use reduction		Solvent use reduction with conventional system	Standard	Preparative (small scale)	Preparative (medium scale)	Preparative (large scale)	Preparative (very large scale)
Cross-Sectional Area (4.6 mm I.D. = 1)	0.05	0.19	0.43	1.00	4.73	18.90	37.05	118.15
Particle Size (µm)	5 or lower				5		15 or higher	

Scale Down

When scaling down from a 4.6 mm I.D. analytical column to a 3.0 mm I.D. or lower column of the same column length, sample loading is proportional to the cross-sectional area of column. 3.0 mm I.D. columns provide good sensitivity and reduce solvent use without the need to change existing equipment. Semi-micro columns (2.0 and 1.0 mm I.D.) provide higher sensitivity for analysis of trace components, but necessitate changing the tubing, injector, and detector cell.

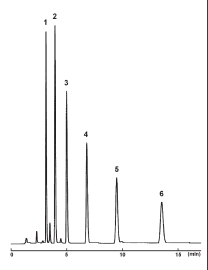
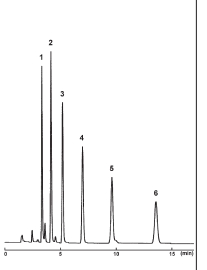
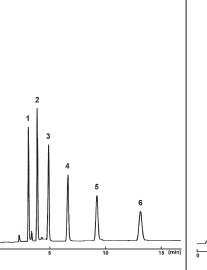
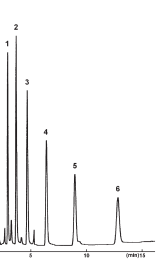
Column Size	4.6 mm I.D. x 150 mm	3.0 mm I.D. x 150 mm	2.0 mm I.D. x 150 mm	1.0 mm I.D. x 150 mm
Chromatogram				
Flow Rate (ml/min)	1.0	0.4	0.2	0.05
Pressure (MPa)	3.4	3.6	3.8	3.6
Injection Volume (µl)	1.0	0.4	0.2	0.05
Detector Cell • Injector	Analytical		Semi-Micro	
Detector sensitivity (AUFS)	0.08		0.04	
Tubing Internal Diameter (mm)	0.25		0.10	0.05

Column	COSMOSIL 5C ₁₈ -MS- II	Sample	
Mobile Phase	Acetonitrile : Water = 70 : 30	1. Benzene	4. Propylbenzene
Flow Rate	1.0 ml/min	2. Toluene	5. Butylbenzene
Temperature	30°C	3. Ethylbenzene	6. Amylbenzene
Detection	UV 254 nm		

Scale Up

When scaling up from an analytical column to a preparative column of the same packing material (particle size) and length, sample loading capacity is proportional to the cross-sectional area of the column.

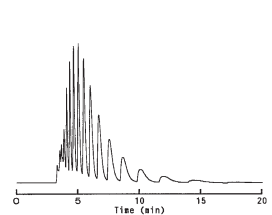
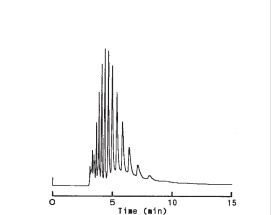
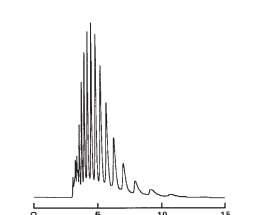
Column Size	4.6 mm I.D. x 250 mm	10 mm I.D. x 250 mm	20 mm I.D. x 250 mm
Chromatogram			
Flow Rate (ml/min)	1.0	5.0	18.9
Pressure (MPa)	5.5	5.9	5.8
Injection Volume (μl)	125	625	2,500
Detector Cell · Injector	Analytical		Preparative
Tubing Internal Diameter (mm)	0.25		1.0

Column COSMOSIL 5SL-II
 Mobile Phase Ethyl Acetate : Ethanol = 4 : 1
 Temperature 30°C
 Detection UV 254 nm
 Sample Triton X-100

Changing Particle Size of Packing Material

When changing the particle size of the packing material from 5 μm to 15 μm, the number of theoretical plate (N) is reduced to one-third, and the pressure is reduced to one-ninth. As shown in the figure below, when a small amount of sample is injected, there is a big difference in the number of theoretical plates. However, when a large amount of sample is injected, there is not much difference between the two. Therefore, the low-pressure packing material (particle size 15 μm) is recommended for preparative columns (28 mm I.D. or larger).

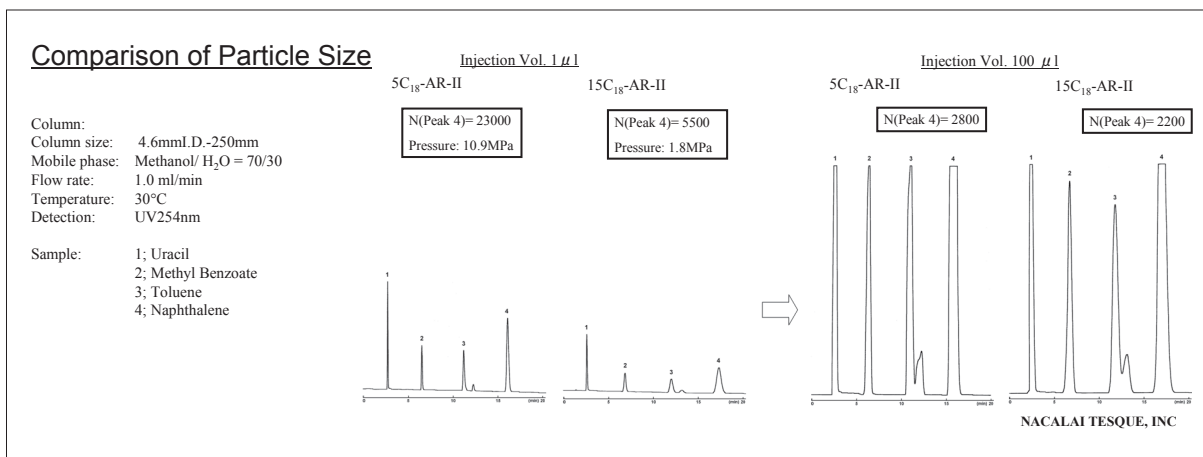

2) Core-Shell and Fully Porous Particles

Scaling up from COSMOCORE 2.6Cholester to COSMOSIL Cholester

Changing conditions from UHPLC to HPLC

Column	COSMOCORE 2.6Cholester	COSMOSIL Cholester
Silica Gel	Core-shell silica gel	Fully porous silica gel
Average Particle Size (µm)	2.6	5
Average Pore Size (Å)	90	120
Surface Area (m ² /g)	150	300
Bonded Group	Cholesteryl	
Column Size	2.1 mm I.D. x 100 mm	4.6 mm I.D. x 250 mm
Instrument	UHPLC	HPLC
Flow Rate (ml/min)	0.4	1
Tubing Internal Diameter (mm)	0.1	0.25

UHPLC to HPLC

By adjusting the analysis conditions, similar separation is achievable on both HPLC and UHPLC. When changing from COSMOCORE 2.6Cholester (2.1 mm I.D.) to COSMOSIL Cholester (4.6 mm I.D.), the injection volume was increased by a factor of more than 5.

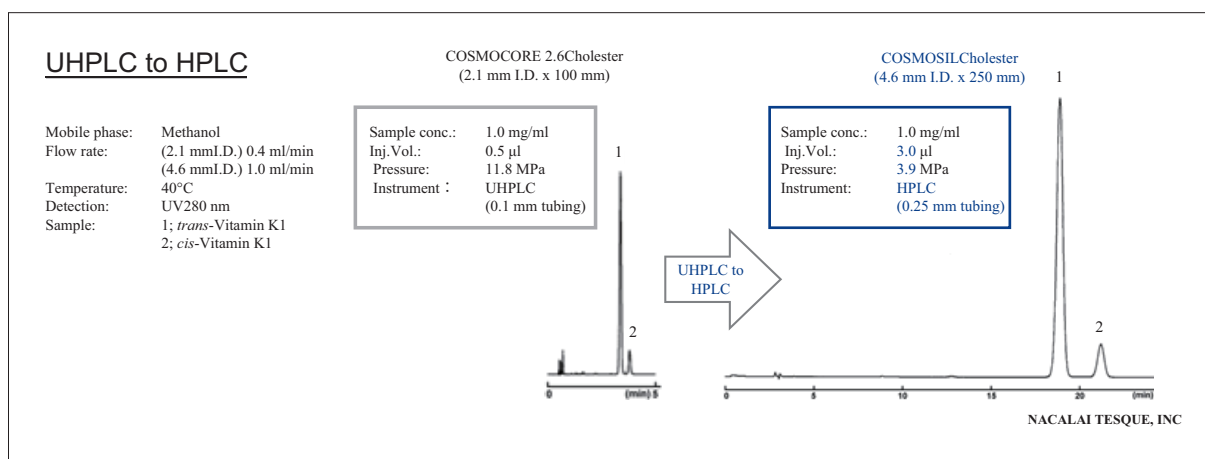

Determining Loading Capacity

Before scaling up to a preparative column, gradually increase the sample load on an analytical column to determine the optimal sample load.

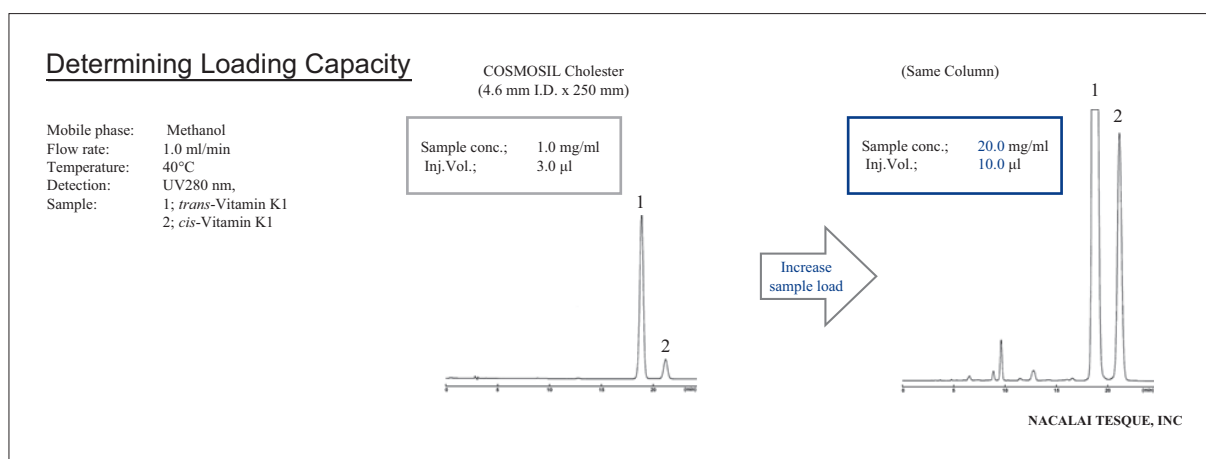

Transferring a Method to a Preparative Column

Recommended conditions for different column diameters

Internal diameter (mm I.D.)	4.6	10.0	20.0	28.0	50.0
Standard flow rate (ml/min)	1	5	19	37	70
Detector cell, injector	Analytical		Preparative		
Tubing Internal Diameter (mm)	0.2-0.3		1.0		
Application	Analytical	Preparative (small-scale)	Preparative (medium-scale)	Preparative (large-scale)	Preparative (very large-scale)
Cross-sectional area relative to 4.6mm I.D. column	1	4.73	18.9	37.05	118.15

Moving from analytical to preparative

When moving from a 4.6 mm I.D. column to a 10 mm I.D. column (same length), similar separation can be achieved by increasing both the mobile phase flow rate and the injection volume by a factor of about 5. For other diameters, the flow rate and sample load should be increased by the ratio of the cross-sectional areas (see table above).

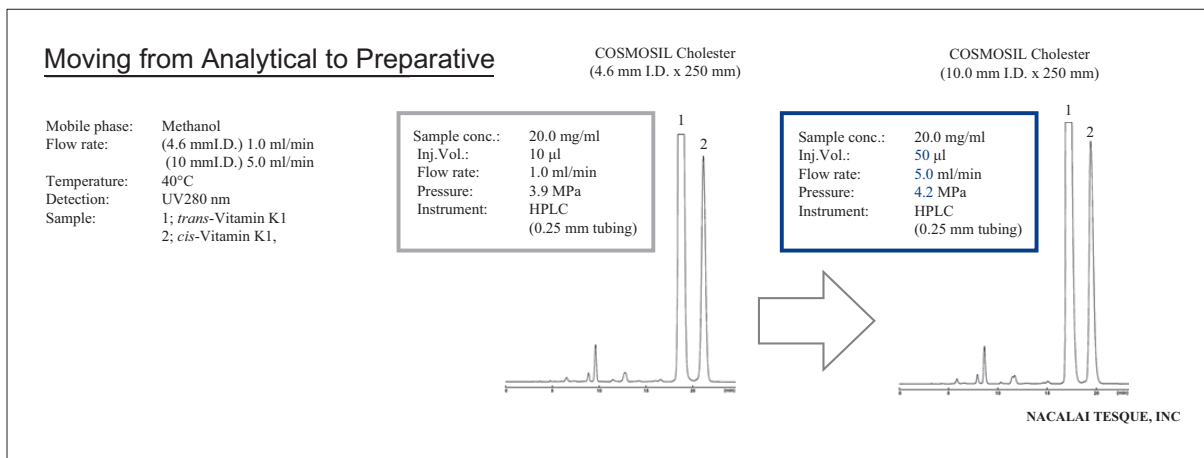

Introduction

Repeated analysis may increase back pressure. Continuous use of HPLC columns under excessive pressure can cause deterioration and overload of the equipment. Therefore, it is important to monitor backpressure regularly and resolve issues before they damage the system or columns.

Identification of the Clogging Site

Backpressure increase can be due to clogging of the column or equipment. First, it is necessary to identify the clogging site.

Disconnect the system components one by one to identify the clogged component(s). Start by disconnecting the column from the system and measuring the pressure of flowing mobile phase. The pressure should be close to zero. If the pressure without a column is normal, then the pressure increase is due to clogging in the column. The column may need to be washed or replaced.

Schematic Diagram of HPLC

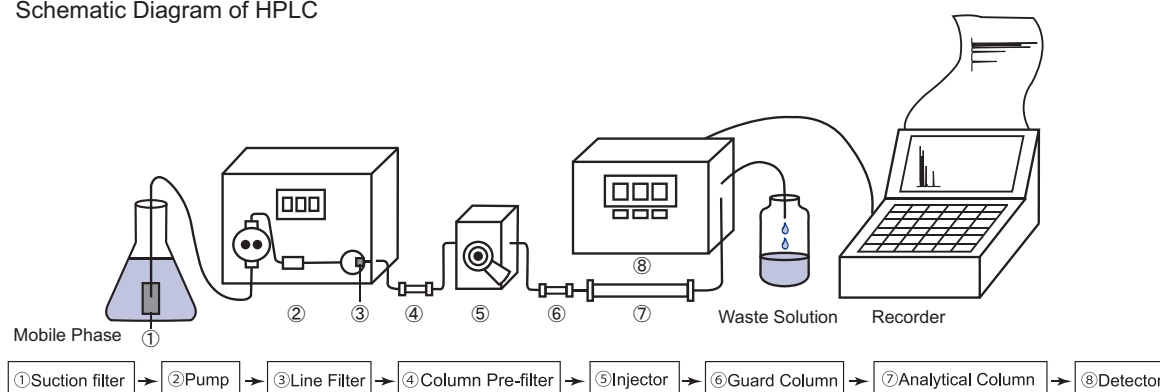

If elevated pressure is observed with the column disconnected, proceed to disconnect system components starting with the detector and moving backwards to the pump(s). If the pressure returns to normal, the component disconnected last can be identified as the problem.

Clogging of Equipment

Identify the specific clogging site according to the method above.

(Case 1) High pressure caused by clogged tubing

Cause: Salt deposit in tubing.

Solution: Disconnect the column and any other equipment before pumping water through the tubing. Washing in the reverse direction is also effective. If the situation does not improve, replace the tubing.

(Case 2) High pressure caused by clogged pump

Cause: Line filter of pump is clogged.

Solution: Take apart the line filter, and soak it in solvent, then clean with an ultrasonic cleaner. If the situation does not improve, replace the line filter with a new one.

(Case 3) High pressure caused by clogged manual injector

Cause: Manual injector is clogged.

Solution: Inject 20ml of a solvent that can dissolve the contaminant (e.g., methanol) by syringe. Wash both lines in LOAD and INJECT position. Disassembling and cleaning the injector in an ultrasonic bath is also effective. If solids caused the clogging, wash the injector in the reverse direction. If the situation does not improve, replace the injector with a new one.

What should I do when a clogged column causes pressure increase?

(Case 1) Salt deposit in a column caused by pumping high-organic solvent after using buffer solution

- Cause: Salt deposit in a column.
- Solution: Wash columns for 30 minutes at half the normal flow rate using 10% organic solvent (methanol or acetonitrile) in water to dissolve salt deposit. If the situation does not improve, wash the column with 100% water under the same conditions.
- Prevention: To switch to high-organic solvent concentration after using a buffer, first wash the column with a salt-free mobile phase (with the same concentration of organic solvent as the buffer), then switch to the mobile phase of higher organic concentration.
- Example : To change mobile phase from 10/90 (v/v) acetonitrile/20mmol/l phosphate buffer (pH2.5) to 50/50 (v/v) acetonitrile/water, first wash the column for 15 minutes with 10/90 (v/v) acetonitrile/water, and then switch to 50/50 (v/v) acetonitrile/water.

(Case 2) The sample is not completely dissolved or is not filtered

- Cause: Column frit is clogged by insoluble sample or impurities.
- Solution: Connect the column in the reverse direction, disconnect from the detector, and wash the column for 30 minutes at half of the normal flow rate with the same mobile phase used for analysis. If the situation does not improve, change the frit in the front end of the column. (We can replace end fittings as a paid service. Ask us for details.)
- Prevention: We strongly recommend filtering the sample. For more information, please see page 31.
- Caution: If the column is frequently washed in the reverse direction, it may deteriorate.

(Case 3) Protein samples that adsorb easily to the column or samples that are not very soluble in mobile phase

- Cause: Samples have adsorbed to packing material or deposited in a column.
- Solution: Wash the column for 30 minutes at half of the normal flow rate using a solvent that can dissolve the adsorbed substances.
- [Reversed phase columns]
- a) If the adsorbed substances are not proteins, wash with methanol and/or tetrahydrofuran.
- b) If the adsorbed substances are proteins, wash with 50-70% acetonitrile in water (containing 0.1% trifluoroacetic acid). Proteins may precipitate in high-organic solvents, so be cautious.
- [COSMOSIL SL-II] Wash with methanol, tetrahydrofuran, or ethanol.
- [Fullerene columns] Wash with *o*-dichlorobenzene or 1,2,4-trichlorobenzene.
- [COSMOSIL Sugar-D/NH₂/HILIC columns] Wash with 50/50 (v/v) acetonitrile/water for NH₂-MS, or 100% water for Sugar-D and HILIC columns.
- Prevention: (a) Choose appropriate pretreatment for each sample. For more information, please see page 31.
(b) We also recommend using guard columns. Please see page 37.
- Notes:
- When washing columns, disconnect the column from the detector. Let the solvent flow into waste.
 - Excessive washing may deteriorate the performance of columns.
 - Do not use strongly alkaline solutions (greater than pH 7.5) or strongly acidic solutions (less than pH 1.5) for silica-base packing material.
 - Store columns in manufacturer-recommended storage solvent after washing.
 - If the column performance does not improve after washing, replace the column.

(Case 4) Gradual pressure increase over time

- Cause 1: Contamination of column from normal long-term use.
- Solution: Wash the column as in Case 3 above.
- Cause 2: Column deterioration over time.
- Solution: Replace the column.

No improvement after trying the above



You can continue to use the column at elevated pressure if peak shape is acceptable and the maximum pressure is less than the limit for the column (see the column manual for details). However, we recommend replacing the column to lessen the pressure burden on the instrument.

(4) Sample Pretreatment for HPLC

Pretreatment before HPLC analysis is often required for samples of low concentration or samples containing analytical contaminants. It improves reproducibility and sensitivity in analysis, and protects HPLC columns. The pretreatment methods are different for each sample. The following are examples of different methods.

1) Filtration

Filtration is a common method used for separating solids from liquids. It extends a column's life by minimizing damage from solid contaminants such as particles, sediments, and colloids. It also improves reproducibility of analytical data. We offer both syringe-type and spin-type filters for sample filtration.

	Syringe Filter	Centrifugal Filter
Product	Cosmonice Filter	Cosmospin Filter
Configuration		
Usage	Easy to use Just attach a filter on top of a syringe	Easy to use by centrifugation
Type	W (for aqueous solutions) S (for organic solvents)	Pore diameter: 0.2 μm Pore diameter: 0.45 μm
Required Equipment	Syringe, Sample Bottle	Centrifuge

Cosmonice Filter

How to use :

1. Fill a syringe with the sample you want to filter.
2. Attach a Cosmonice filter to the syringe.
3. Push the syringe plunger to filter the sample.
4. Analyze the filtered sample by HPLC.

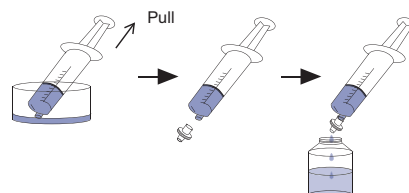

Cosmospin Filter

Components : Sample Reservoir
Sample Collection Tube

How to use :

1. Insert the sample reservoir into the sample collection tube.
2. Add a sample to the sample reservoir.
3. Close the sample collection tube cap and centrifuge.
4. Remove the sample reservoir, and collect the filtered sample in the sample collection tube.
5. Analyze the filtered sample by HPLC.

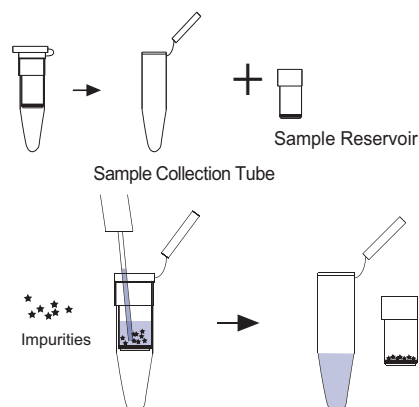

2) Protein Precipitation

Protein precipitation is commonly used to remove proteins in samples for downstream analysis. For example, when analyzing drug concentration in blood samples, proteins have to be removed first. Otherwise, proteins may be adsorbed in columns and interfere with the analysis. Common methods of protein precipitation include salting out, isoelectric precipitation, and precipitation with organic solvents. A general procedure for protein precipitation with organic solvents is shown on the right.

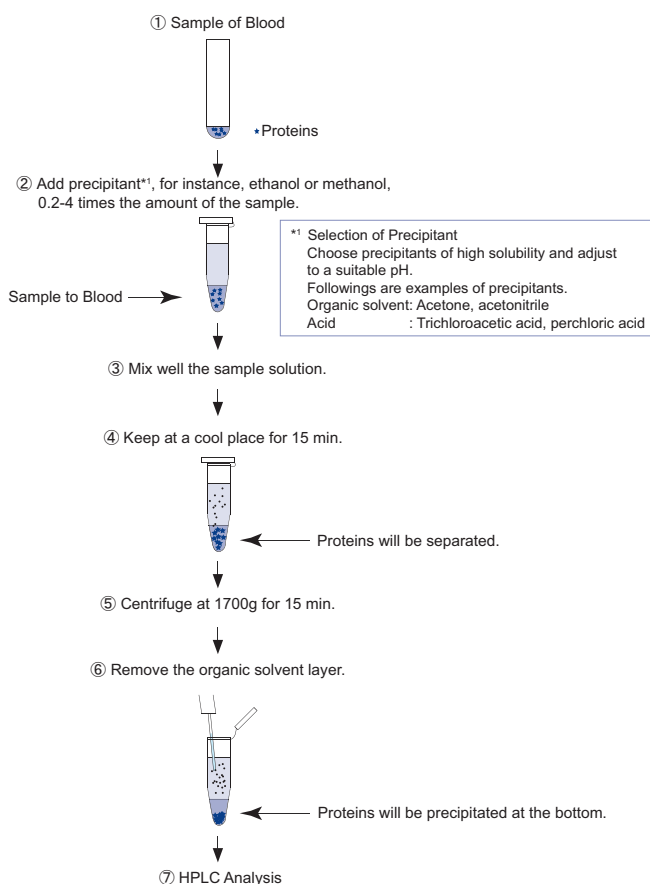

3) Ultrafiltration

Ultrafiltration is a method to concentrate proteins or other macromolecules through a semipermeable membrane with defined pores. Ultrafiltration is used for sample desalting, concentrating proteins from a dilute solution (such as urine samples), or removing proteins from samples with high protein concentration (such as blood serum or plasma). A general procedure for ultrafiltration is shown at the right.

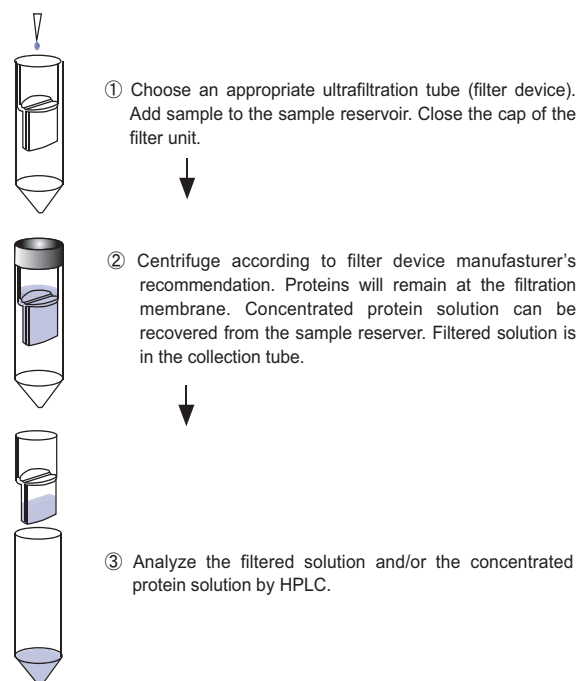

4) Solvent Extraction Method

Solvent extraction is a method to separate compounds using their unequal solubility in two immiscible liquid phases, usually water and an organic solvent. This method is used to concentrate highly hydrophobic compounds, and thus increase analytical sensitivity. A buffer solution is added to the sample to optimize the pH, and the target substance is then extracted by an organic solvent such as ether or chloroform. However, when target substance is bound to protein, solvent extraction may not be effective.

General Procedure for Solvent Extraction:

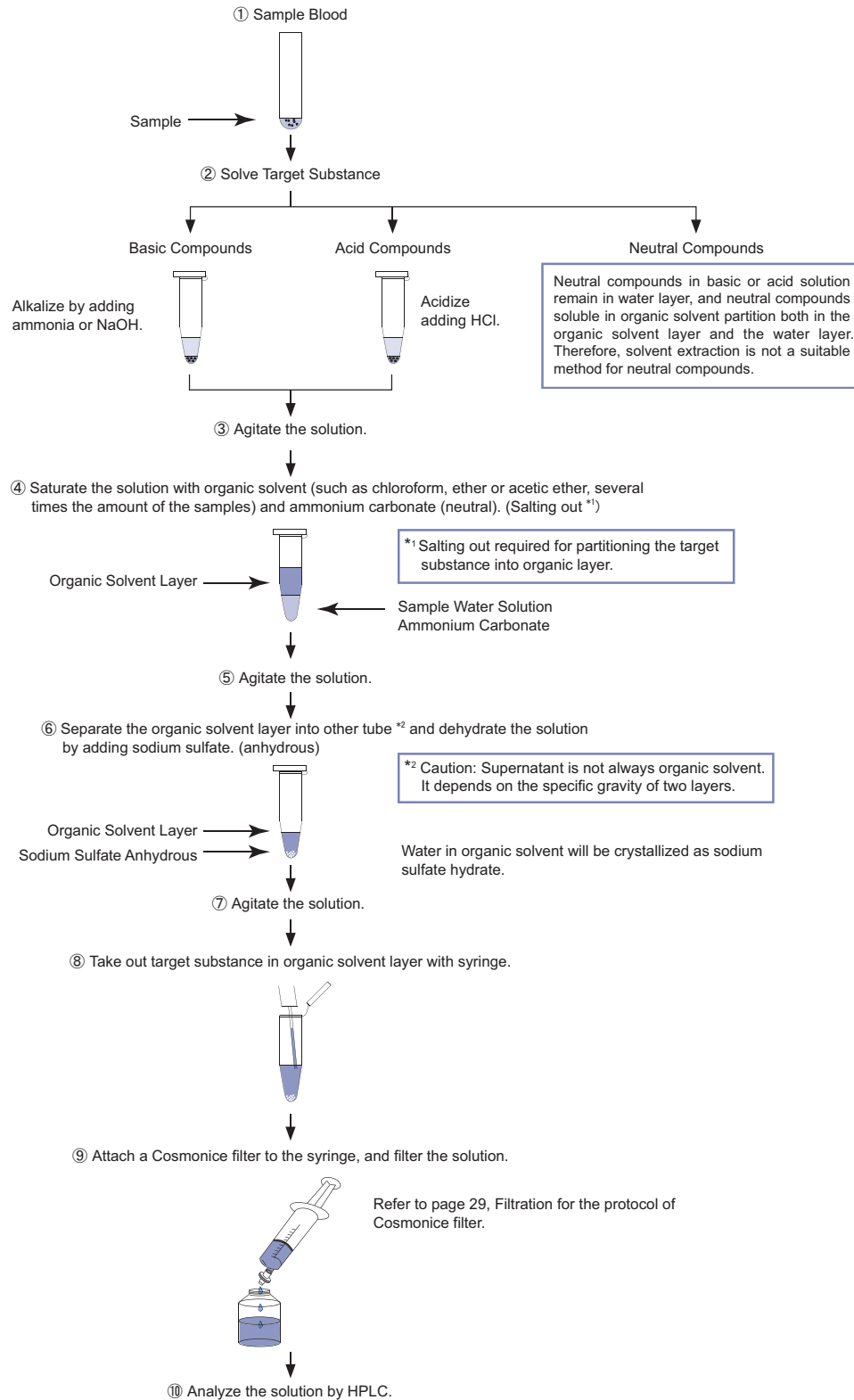

5) Ion Exchange

Pretreatment by ion-exchange resin can be effective for samples that the solvent extraction method cannot separate. A preliminary experiment may be required for the selection of resin and experimental conditions. For example, a negatively charged compound is strongly adsorbed on an anion-exchange resin, such as DEAE cellulose resin. The target compound is collected by increasing salt concentration of buffer solution or adjusting pH of elution buffer after washing off other weakly adsorbed, undesired substances.

General Procedure for Ion Exchange:

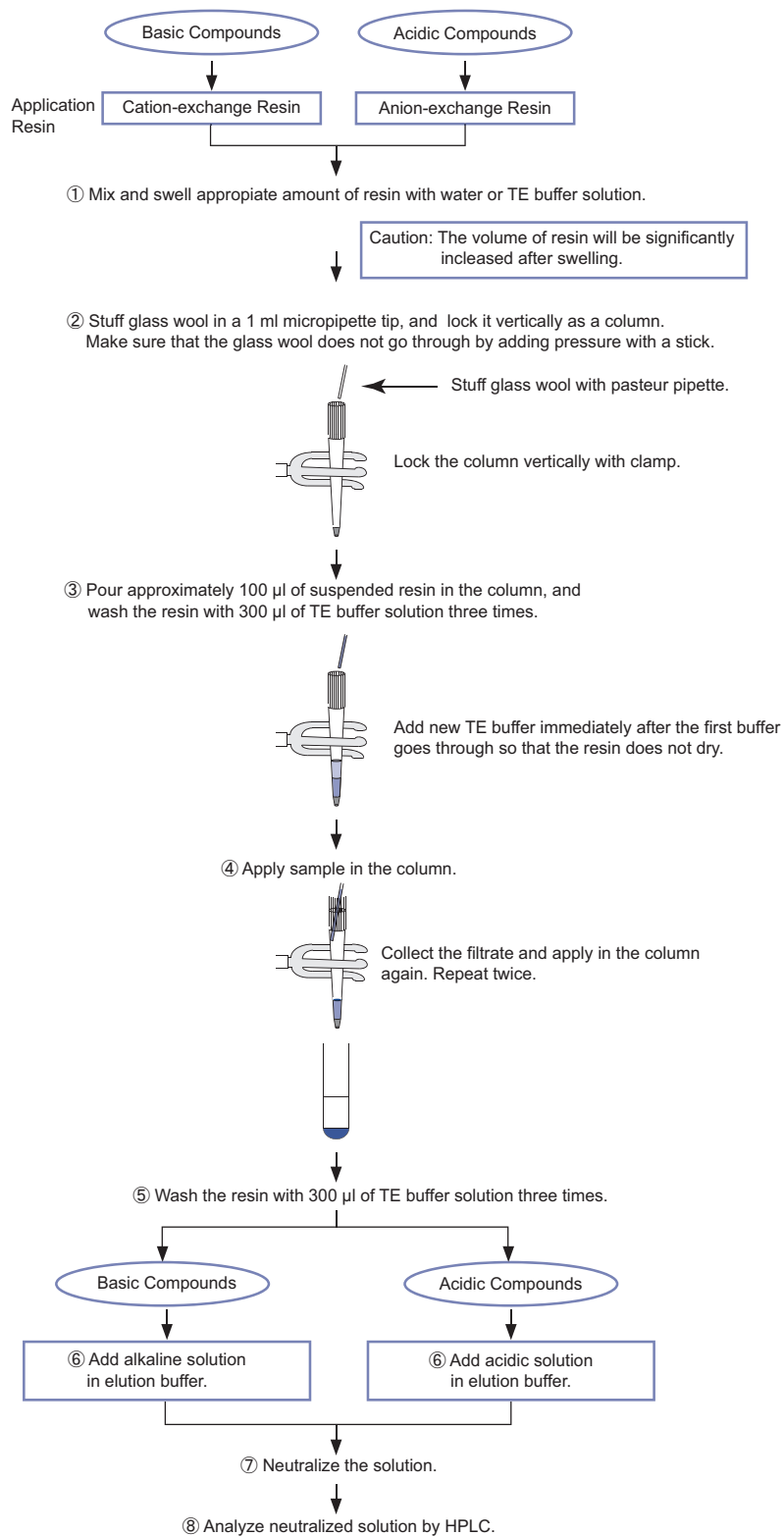

6) Solid Phase Extraction

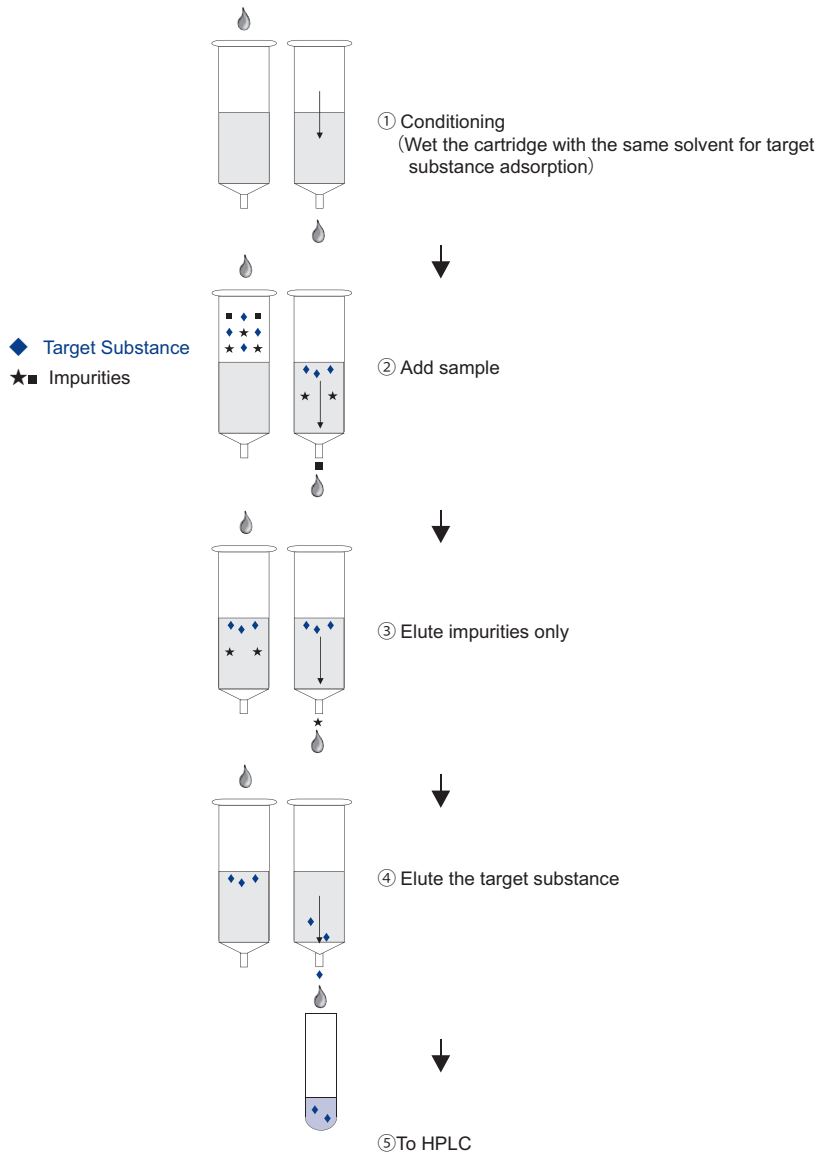

(5) Baseline Noise in Gradient Elution

In gradient analysis, incomplete mixing of mobile phases or impurities in water can cause baseline noise. In the former case, it can be improved by using a proper mixer before the injector (baseline 1→2). In the latter case, it can be improved by using a pre-column. Impurities in water are adsorbed to the pre-column (baseline 2→3). COSMOSIL 5C₁₈-AR-II is effective as a pre-column (4.6 mm I.D. x 10 mm, or 10 mm I.D. x 20 mm).

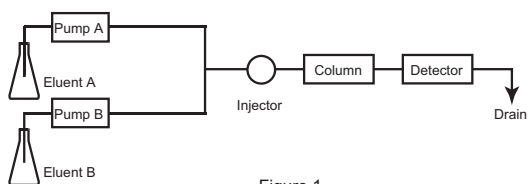
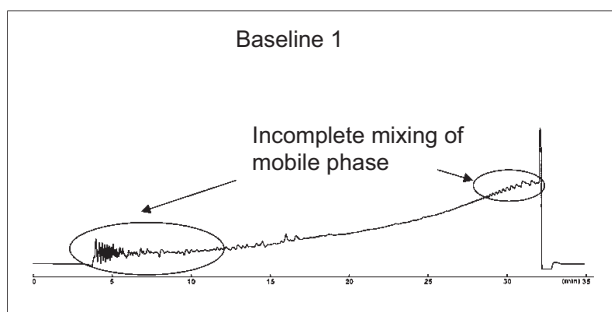

Figure 1



↓ + Mixer

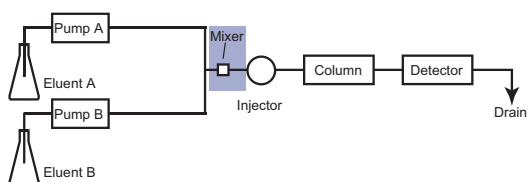
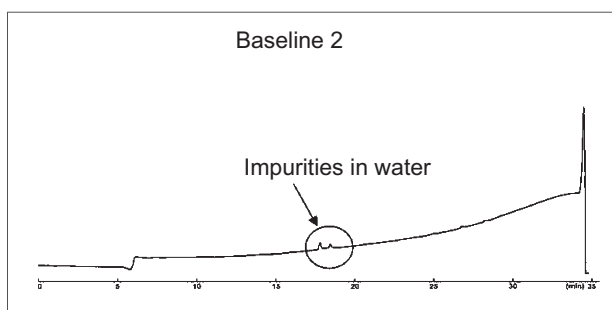

Figure 2



↓ + Pre-column

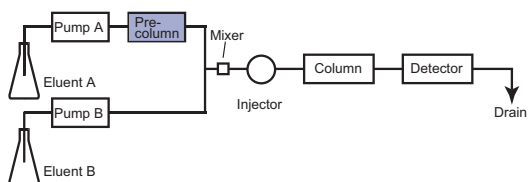
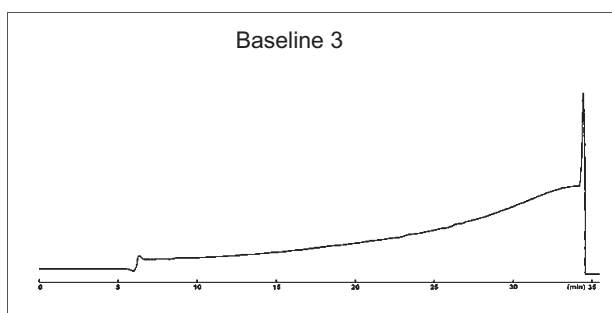

Figure 3



Column COSMOSIL 5C₁₈-AR-300 4.6 mm I.D. x 150 mm
 Precolumn COSMOSIL 5C₁₈-AR-II 4.6 mm I.D. x 10 mm
 Mobile phase A: 0.1% TFA containing water
 B: 0.1% TFA containing 95% acetonitrile
 B: 0% → 100%/30 min liner gradient
 Flow rate 1.0 ml/min
 Temperature 30°C
 Detection UV 220nm

Introduction

The use of guard columns to protect both analytical and preparative columns is highly recommended. COSMOSIL guard columns are packed with identical packing material to analytical and preparative columns. As a result, COSMOSIL guard columns do not affect the performance of the main column.

Selection of Guard Column

Use a guard column with the identical packing materials to the analytical or preparative column. Regarding size, use the same or smaller inner diameter, and short column length (10–50 mm). For more information on the product code or size, please refer to our catalog or web site.

Example: If the main column is 5C18-MS-II (20 mm I.D. x 250 mm), 5C18-MS-II (10 mm I.D. x 20 mm) is effective as a guard column.

Guard Cartridge

For common sizes (4.6 mm I.D. x 10 mm), guard columns and economically priced guard cartridges are both available. Guard cartridges are disposable guard columns with identical packing materials to analytical columns. When using guard cartridges, a COSMOSIL guard cartridge holder (product no. 38009-79) is required. The holder is reusable.



COSMOSIL Guard Cartridge Holder (Left)
Guard Cartridge (Right)

Structure of Cartridge

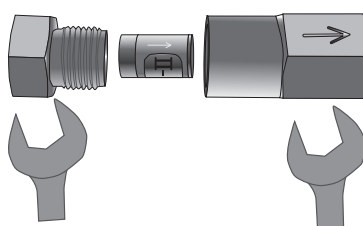

For more information on how to use the guard cartridge, see the attached instruction manual.

Connection to Guard Column

Use COSMOSIL column connecting tube (product no. 37843-69).

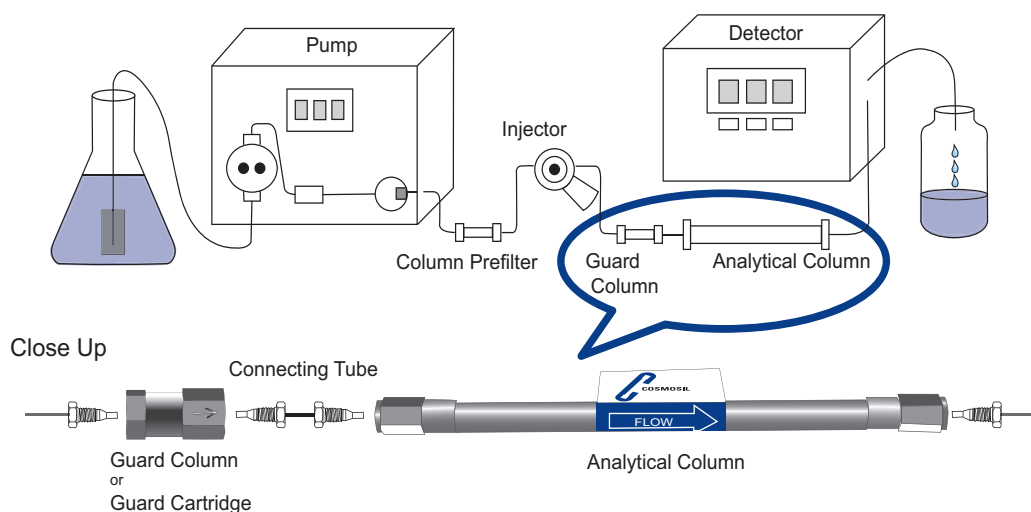

Example of Using Guard Column

The following chromatograms show the use of a COSMOSIL 5C₁₈-MS-II analytical column (4.6 mm I.D. × 150 mm) and the same column connected with its guard column (4.6 mm I.D. × 10 mm). There is no difference in separation characteristics, since the packing material is identical in both the guard column and the main column.

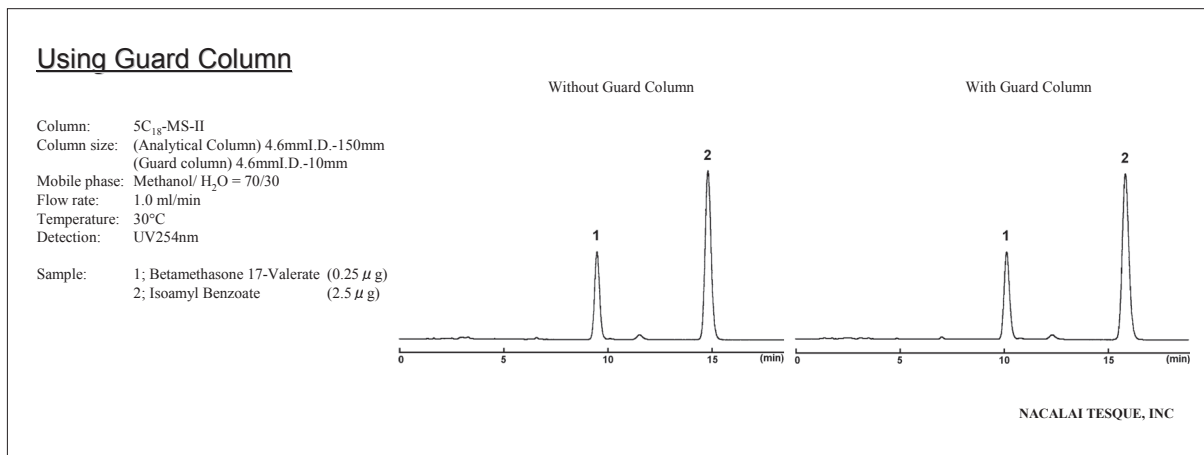

Replacing Guard Column

The following chromatograms show peak shape and performance recovered by replacing a deteriorated guard column with a new one. When pressure increases, ghost peaks appear, or the base line shifts, promptly replace the guard column with a new one. Continued use of a deteriorated guard column can result in premature deterioration of the main column.

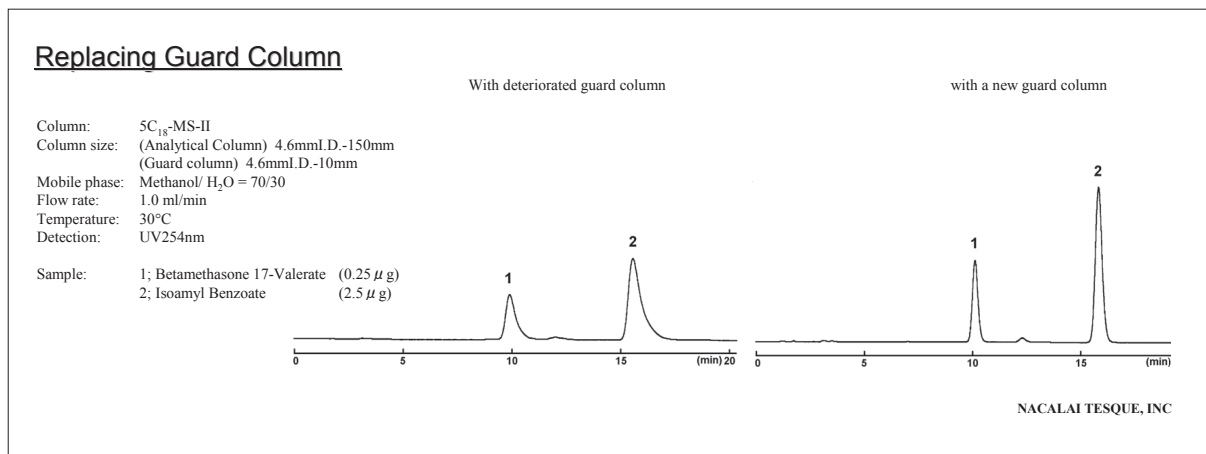

(7) Selectivity of Packing Materials in Reversed Phase Liquid Chromatography

Introduction

Reversed phase chromatography is the most commonly used method of HPLC because of its high theoretical plate number, excellent separation characteristics, reproducibility, and ease of use. Columns packed with octadecyl group-bonded silica gel (C₁₈, ODS) are the most widely used. However, C₁₈ columns do not provide sufficient separation for compounds similar in hydrophobicity because their main separation mechanism is the hydrophobic interaction. Using longer columns, changing mobile phases or changing temperature may improve separation. However, in many cases, it is most effective to use different packing materials which retain compounds using a secondary interaction in addition to the hydrophobic interaction. Nacalai Tesque offers a variety of reversed phase packing materials. These are summarized in Table 1. Retention of compounds depends on the summation of all interactions. Therefore, comprehension of each interaction helps to select an appropriate column.

Table 1. Stationary phase and interaction of packing materials

Packing Material	C ₁₈ -MS-II	C ₁₈ -AR-II	Cholester	PYE	πNAP	PE-MS	NPE	PBr	PFP	C ₈ -MS
Silica Gel	High Purity Porous Spherical Silica									
Particle Size	5 μm									
Pore Size	approx. 120 Å									
Specific Surface Area	approx. 300 m ² /g									
Bonded Phase										
	Octadecyl Group	Octadecyl Group	Cholesteryl Group	Pyrenylethyl Group	Naphthylethyl Group	Phenylethyl Group	Nitrophenylethyl Group	Pentabromo-benzyl group	Pentafluoro-phenyl group	Octyl Group
Bonding Type	Monomeric	Polymeric	Monomeric	Monomeric	Monomeric	Monomeric	Monomeric	Monomeric	Monomeric	Monomeric
Main Interaction	Hydrophobic Interaction	Hydrophobic Interaction	Hydrophobic Interaction Molecular Shape Selectivity	Hydrophobic Interaction π-π Interaction Dispersion Force Molecular Shape Selectivity	Hydrophobic Interaction π-π Interaction	Hydrophobic Interaction π-π Interaction	Hydrophobic Interaction π-π Interaction Dipole-dipole Interaction	Hydrophobic Interaction Dispersion Force	Hydrophobic Interaction π-π Interaction Dipole-dipole Interaction	Hydrophobic Interaction
End-capping Treatment	Near-perfect Treatment									
Carbon Load	approx. 16%	approx. 17%	approx. 20%	approx. 18%	approx. 11%	approx. 10%	approx. 9%	approx. 8%	approx. 10%	approx. 10%

1) Selectivity for Polar Functional Group

Selectivity

Selectivity for polar functional groups was evaluated by separation of benzene, nitrobenzene (nitro group), and anisole (methoxy group). The chromatograms below show separation of the three compounds on four COSMOSIL columns: C₁₈-MS-II, PE-MS, πNAP and PYE. Elution order on the aromatic columns is the reverse of the C₁₈ column. Separation on the C₁₈ column is based on only the hydrophobic interaction. The packing materials of the other three columns have aromatic rings and retain analytes by π-π interaction.

The graph of selectivity for polar functional group is shown above. Of the ten COSMOSIL columns, PYE and NPE columns displayed the highest separation factors. As a mobile phase, methanol is more effective than acetonitrile for separation using π-π interactions.

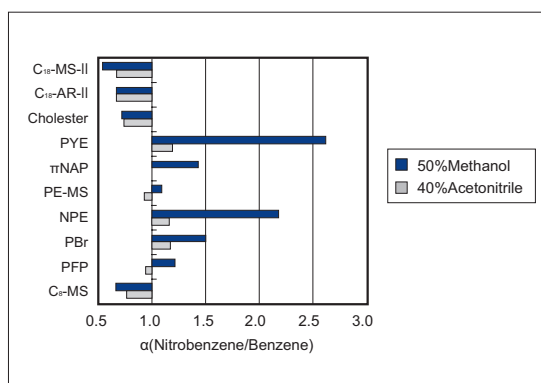

Application

• Separation of Tolunitrile Position Isomers

Tolunitriles have three position isomers. It is difficult to separate ortho and para isomers by C₁₈ or phenyl columns because of weak π-π interaction. However, the isomers are well separated on PYE or NPE, which have strong π-π interactions.

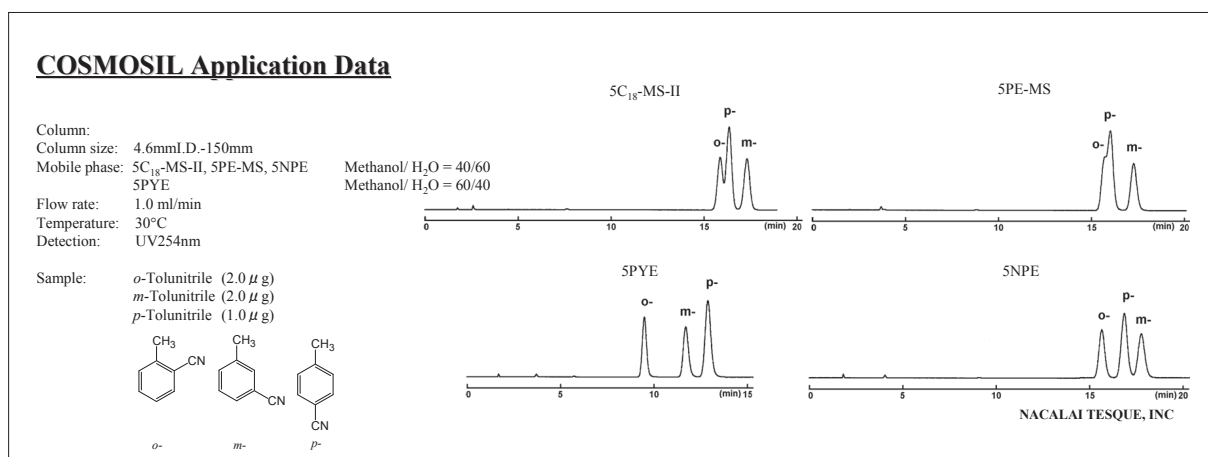

2) Selectivity for Dipole

Selectivity

Selectivity for dipoles was evaluated based on the separation of 1,5-dinitronaphthalene and 1,8-dinitronaphthalene. Dinitronaphthalenes (peak 1 and 2) were strongly retained on PYE and NPE compared to dimethylnaphthalenes due to the π - π interaction. However, there is a slight difference between these two columns. While 1,5-dinitronaphthalene (peak 2) was preferentially retained on PYE, 1,8-dinitronaphthalene (peak 1) was retained longer on NPE. The results with NPE indicate the presence of a strong dipole-dipole interaction. The two nitro group dipoles in 1,8-dinitronaphthalene are aligned for a much greater dipolar coupling with the bonded nitrophenyl group in NPE than 1,5-dinitronaphthalene.

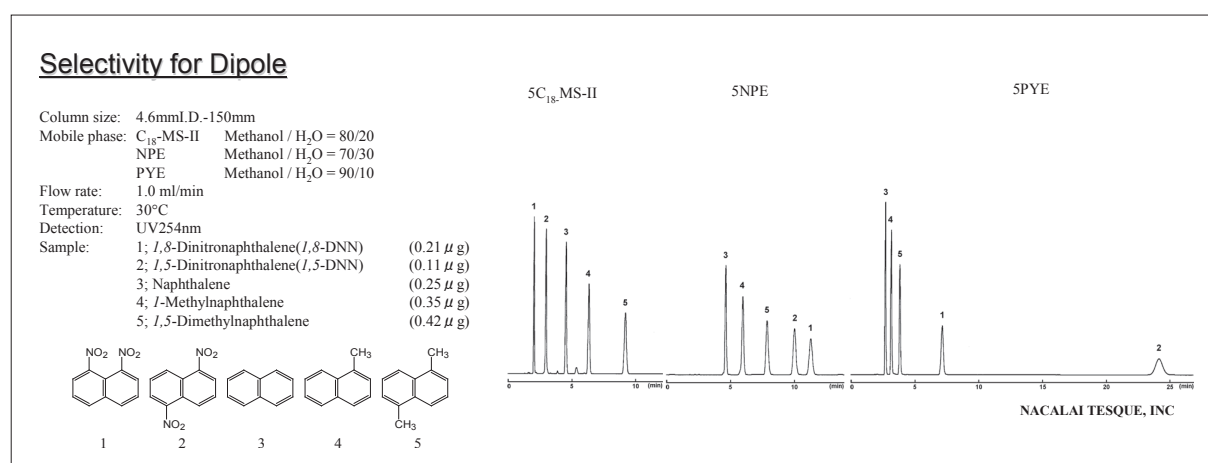
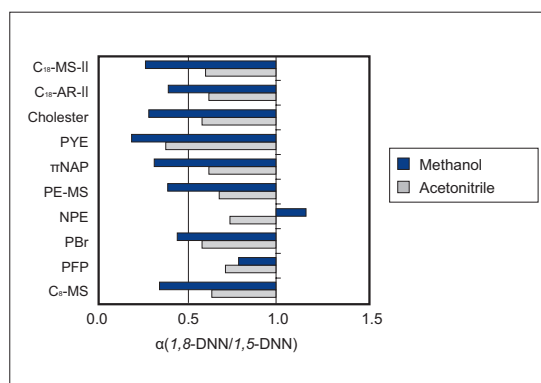

Application

● Separation of Phthalonitrile Position Isomers

Phthalonitriles have three position isomers. NPE and PYE completely separate these compounds using π - π interaction. Furthermore, NPE strongly retains *o*-phthalonitrile due to dipole-dipole interaction.

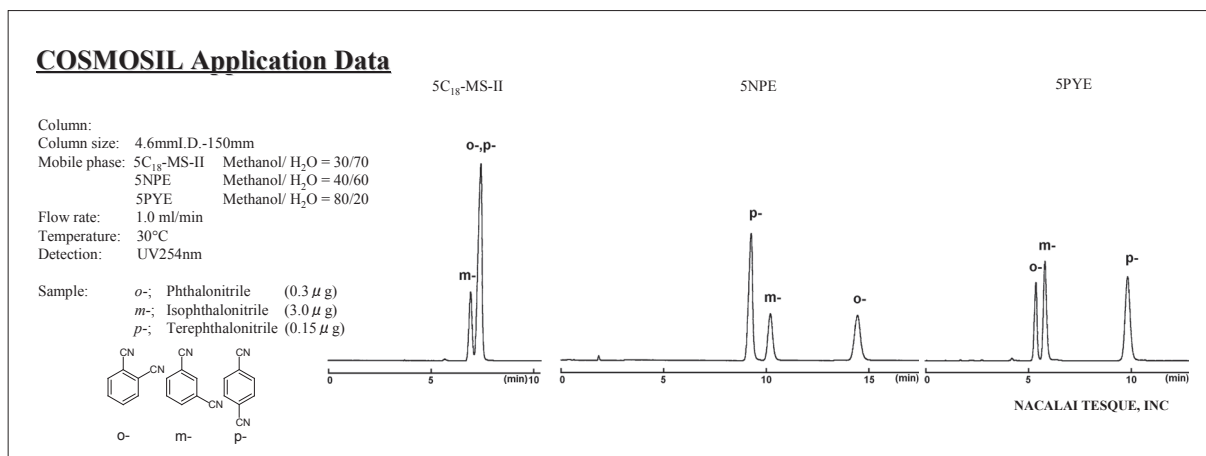

3) Selectivity for Polyaromatic Compounds

Selectivity

Selectivity for polyaromatic compounds is evaluated based on the separation of benzene, naphthalene and anthracene. The elution order in all columns is the same. Retention increases in all columns with increasing number of aromatic rings. In addition, highly dispersive packing materials, such as PBr and PYE, show much stronger retention for polyaromatic compounds due to their dispersion interaction.

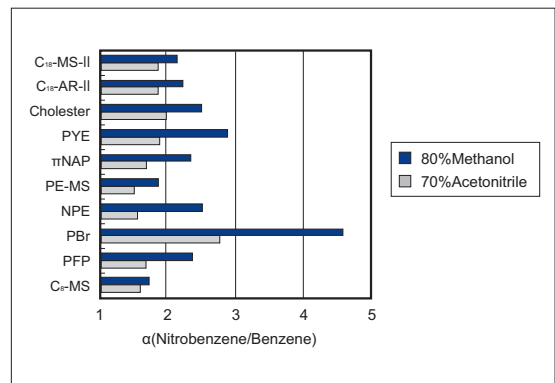

Application

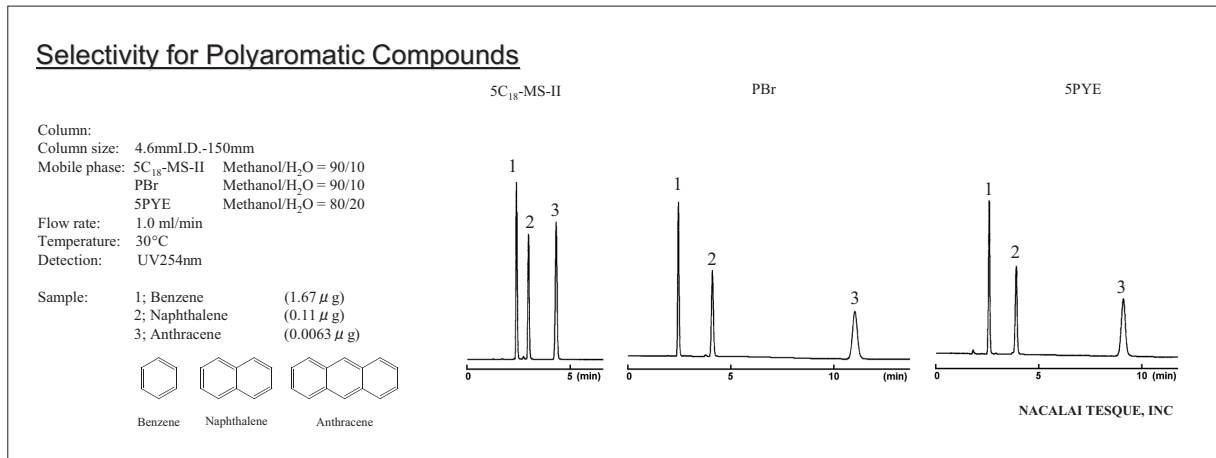

• Separation of Dibenzosuberone and Dibenzosuberone

C₁₈ retains dibenzosuberone (peak 1) longer than dibenzosuberone (peak 2). On the other hand, PBr and PYE retain dibenzosuberone (peak 2), which has a π-electron conjugated system, longer than dibenzosuberone (peak 1).

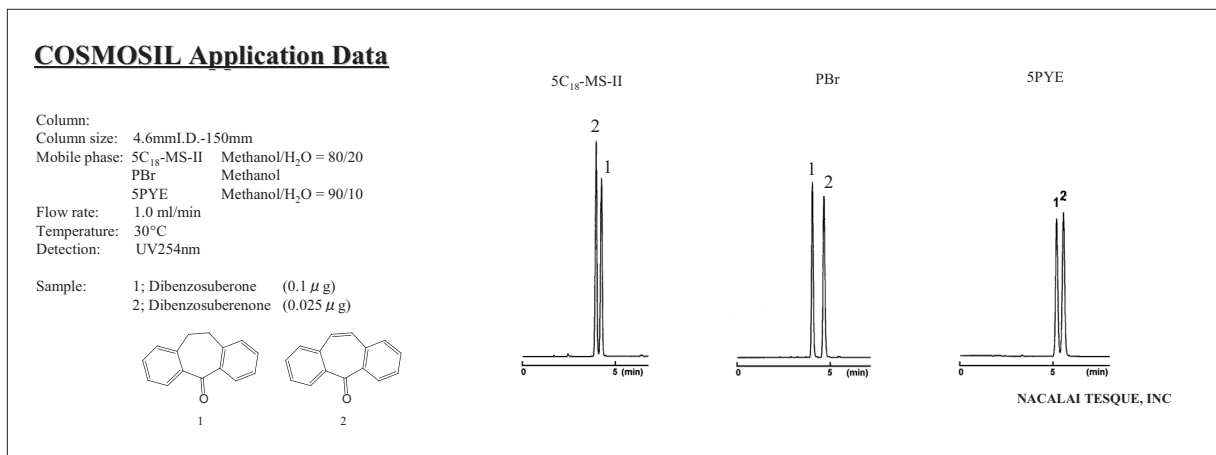

4) Selectivity for Molecular Shape

Selectivity

Selectivity for molecular shape is based on the separation of chrysene and benz[a]anthracene. These isomers, which consist of four benzene rings, are difficult to separate because of the similar hydrophobicity and aromaticity. However, the PYE and Cholester columns, which can recognize molecular shape, separate chrysene and benz[a]anthracene well.

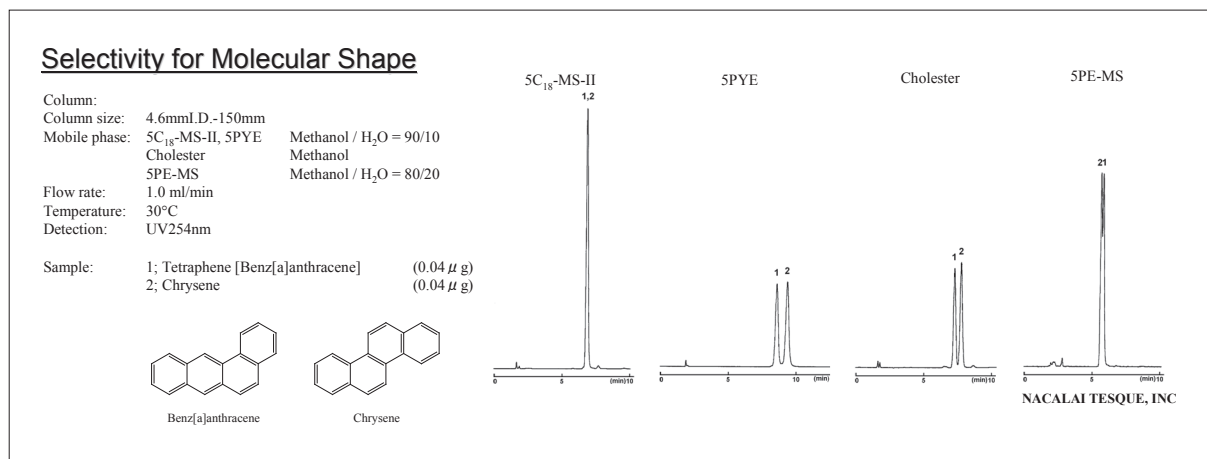
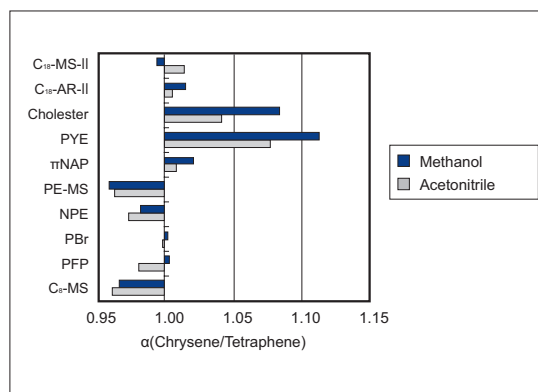

Application

• Separation of Diastereomers (*threo*- and *erythro*-)

C₁₈ cannot separate the *threo* and *erythro* forms. On the other hand, PYE retains the planar *erythro* form longer than the *threo* form.

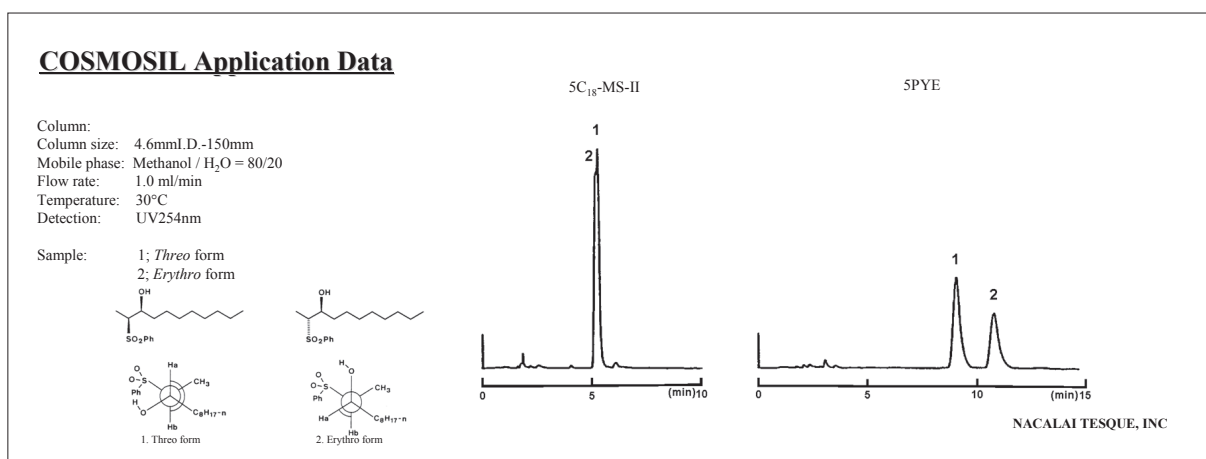

5) Selectivity for Halides

Selectivity

Selectivity for halides is evaluated by the separation of chlorobenzene and bromobenzene. PBr shows the highest separation factor due to the dispersion interaction of its five bromine atoms.

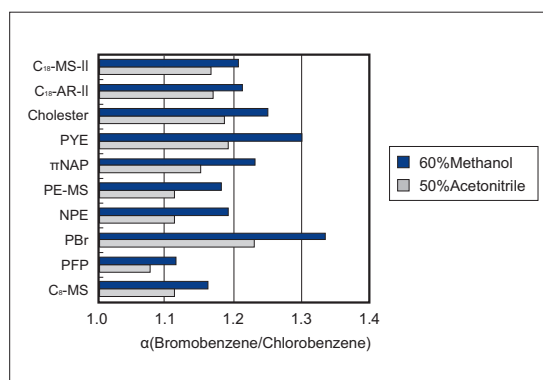

Application

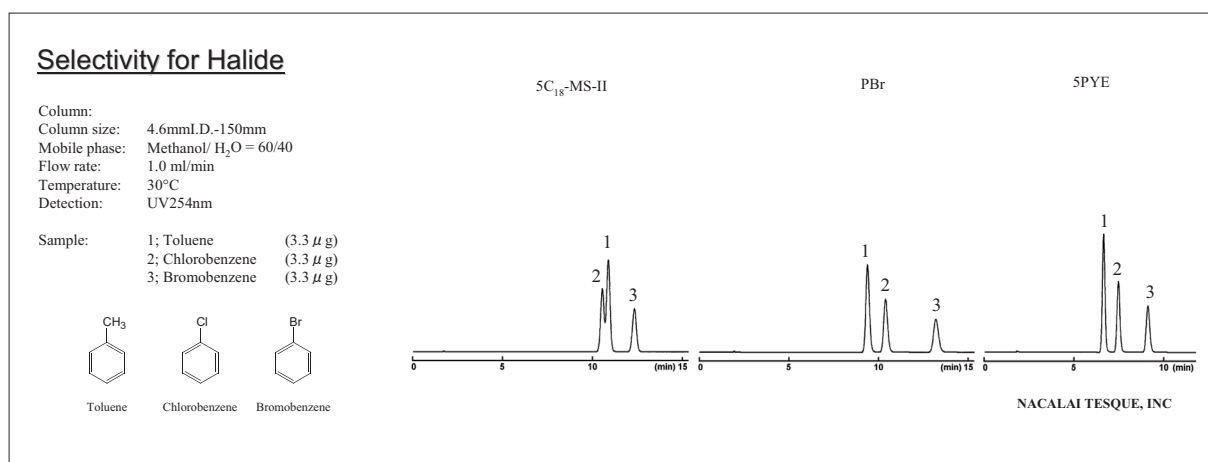

• Separation of Trifluorotoluene and Phenyl Halides

PBr elutes the halogens in order of atomic radius, with the largest retained the longest. As a result, it has excellent selectivity for halide compounds. C₁₈ cannot completely separate some compounds that have similar hydrophobicity.

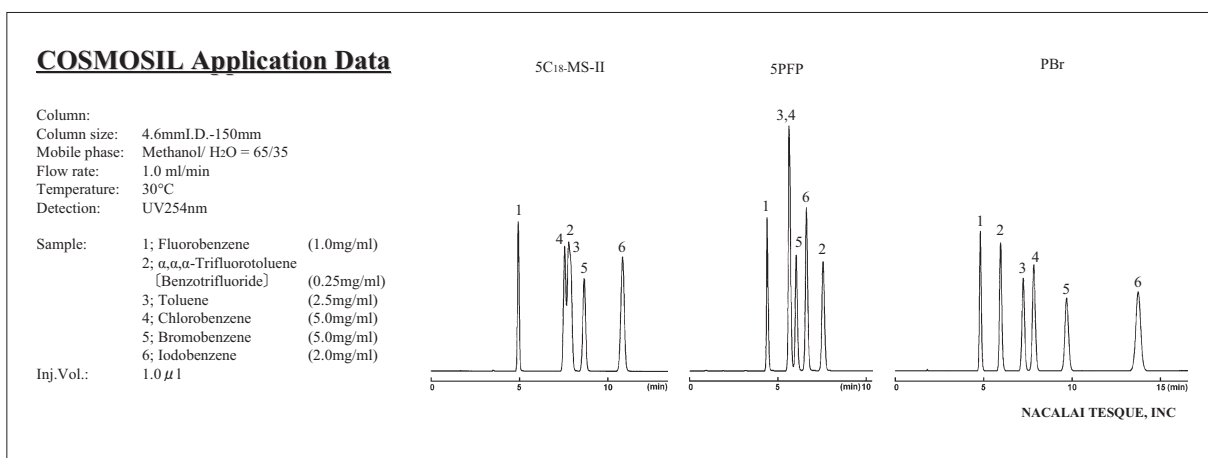

6) Selectivity for Hydrophobicity

Selectivity

Selectivity for hydrophobicity is evaluated by the separation of alkyl benzenes. C₁₈ and Cholester, which have long carbon chains, both display high hydrophobicity. The other columns show less hydrophobicity compared to C₁₈.

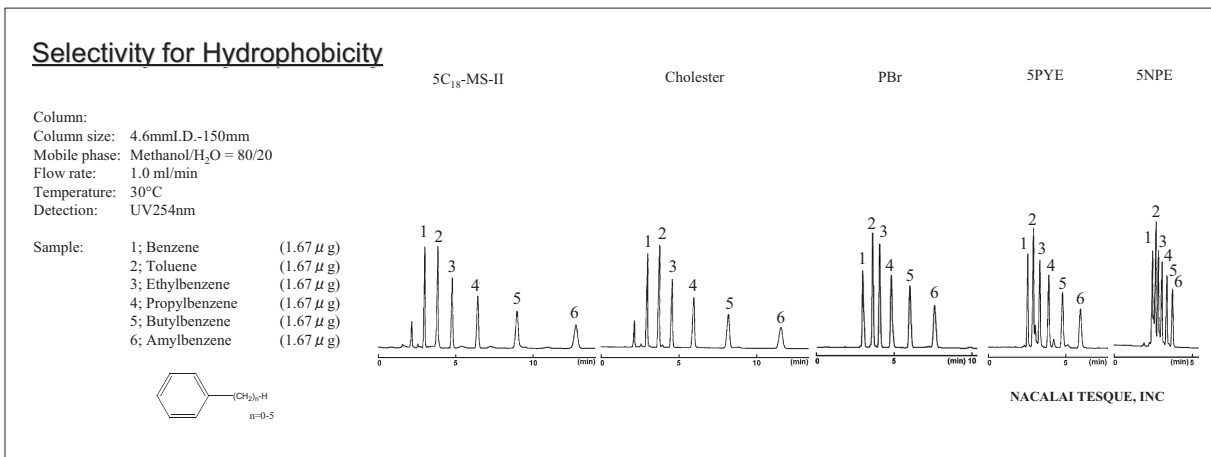
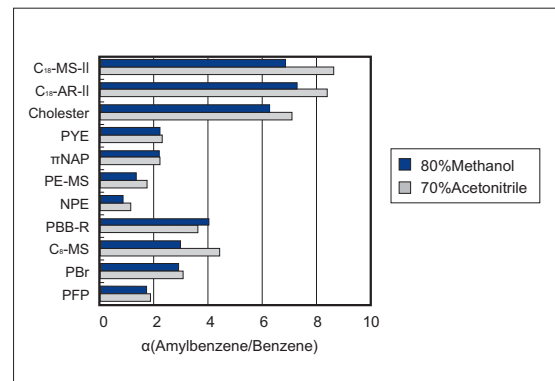

Lower concentration of organic solvent in the mobile phase causes longer retention in reversed phase chromatography. For our NPE column, when the methanol concentration is reduced to 60%, retention increases to about the same as C₁₈ with 80% methanol.

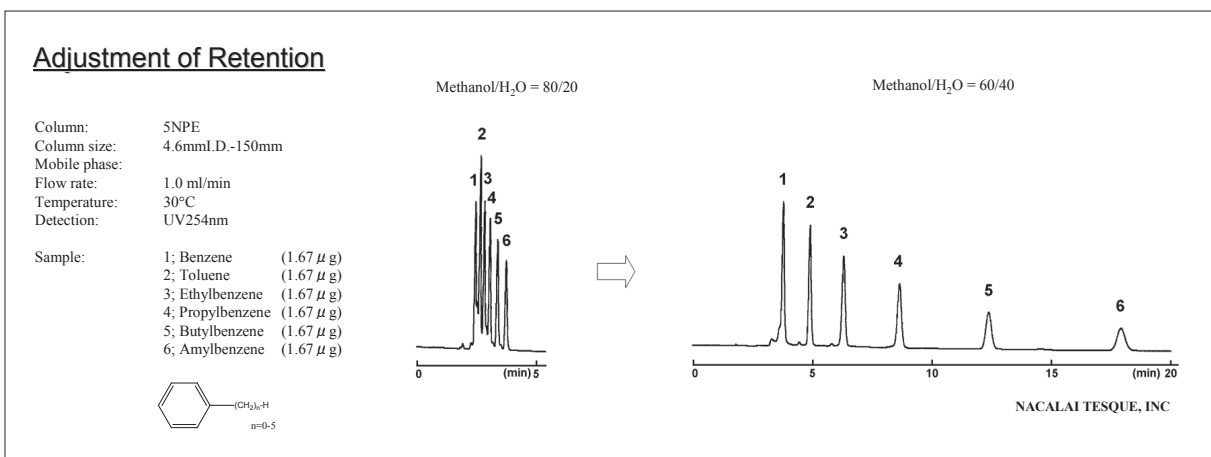

Introduction

In reversed phase HPLC, octadecyl group bonded silica columns (C₁₈, ODS) are the most widely employed. A proper mobile phase condition for C₁₈ columns can be achieved by referring to publications, application notes from manufacturers, and your own experience. This section shows traditional methods for developing mobile phase conditions. The following columns are used as examples because of their popularity.

Packing material : COSMOSIL 5C₁₈-MS-II, COSMOSIL 5C₁₈-AR-II

Column size (I.D. x length) : 4.6 mm I.D x 150 mm

Methods for Developing Mobile Phase Conditions

In isocratic methods, the mobile phase composition remains constant throughout the run. In gradient methods, the mobile phase composition changes. Each method requires precise preparation of the mobile phase and control of the column temperature to achieve good separation.

● Isocratic

Methods for developing mobile phase condition generally proceed as follows. First, elute the samples with strong solvents to check whether the samples can be detected. Then, separate the samples by controlling the retention time with the mobile phase condition. Increasing the concentration of strongly eluting solvents results in shorter retention time, and decreasing their concentration results in longer retention time. If your samples are ionizable, such as acids and amines, pH control with buffers is highly advisable. Buffers and/or ion-pair reagents are used to increase the retention of ionizable samples. Ion-pair reagents (e.g., alkyl benzene sulfonate for basic compounds, quaternary ammonium for acidic compounds) in the mobile phase form ion pairs with samples, increasing their hydrophobicity and retention.

(Example) Procedure for Basic Condition Setting

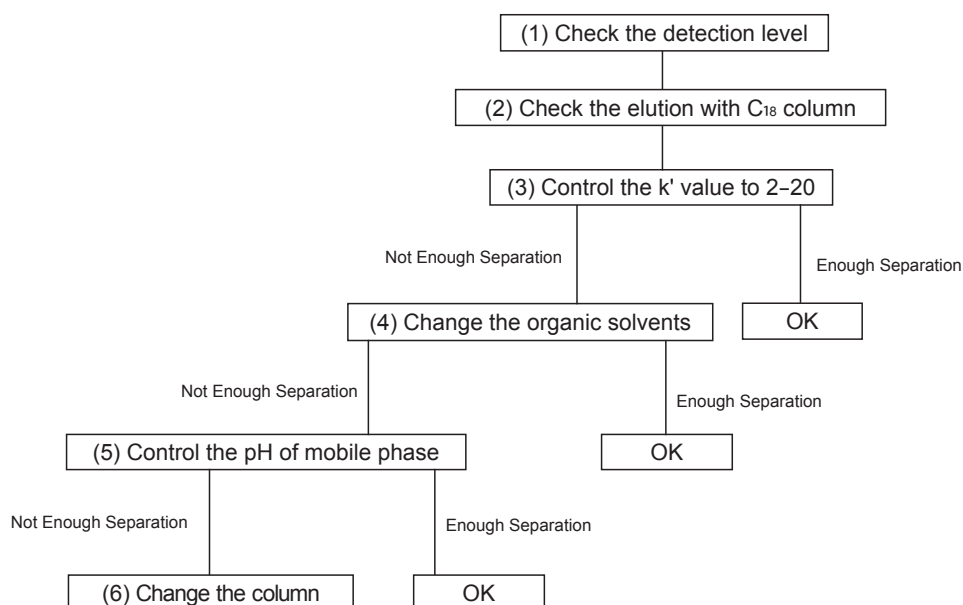

1. Check the detection of samples with strongly eluting solvents. In this step, check the detection by connecting the injector directly to the detector without a column.
2. Consult references and consider carbon numbers, then check elution time with a C₁₈ column using an aqueous mobile phase with methanol.
3. Control the k' value to 2–20 by changing the amount of methanol in the mobile phase.
4. If the separation is not sufficient, change the methanol to acetonitrile or add tetrahydrofuran to change the selectivity.
5. If peak shape is poor with basic or acidic compounds, control the pH by adding buffers to the mobile phase.
6. If separation is still not satisfactory, change the column to another C₁₈ column or a column with different chemistry, such as other alkyl-based, aromatic, or ionic interaction-based stationary phases.

- **Gradient**

Gradient elution changes the organic solvent ratio in the mobile phase continuously. It is useful for shortening the separation time of samples with a wide range of hydrophobicity and molecular weight, which would otherwise have a long elution time and high sensitivity to slight changes in solvent composition. It is also essential for high-molecular weight compounds like peptides. Gradient elution is not compatible with RI detectors, as it produces baseline interference. Gradient method development relies on the user's experience and is beyond the scope of this note.

Easy Method to Determine Reversed Phase Conditions

Reversed phase chromatography does not have an easy method to set mobile phase conditions, unlike normal phase chromatography conditions, which can simply be determined by thin layer chromatography. Therefore, the composition of the mobile phase (concentration of organic solvent) is often determined by trial and error. If you know the structure of the analytes, here is a general method for estimating an appropriate composition.

$$\text{Suitable concentration of organic solvent for basic chemical skeleton} + \text{Effects from substituents} = \text{Estimated optimal organic solvent concentration}$$

• Condition Setting

Select the condition based on retention time of the basic chemical skeleton shown in Figure 1, then adjust for the effect of hetero atom and substituents.

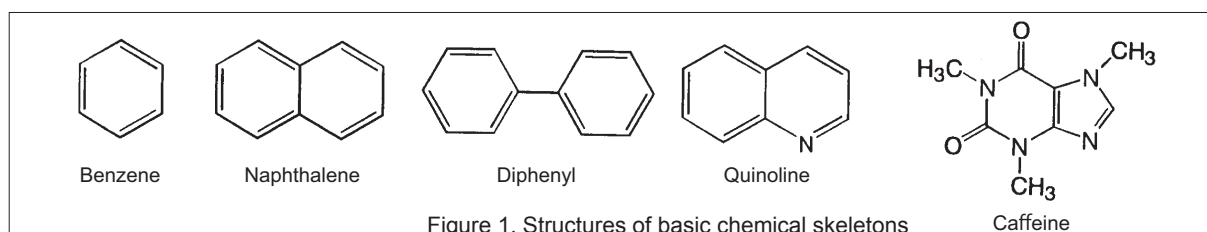

1. Select the best concentration of organic solvent for the sample's basic chemical skeleton. *Table 1

2. Adjust the concentration of the organic solvent for heteroatom effects. *Table 2

3. Adjust the concentration of organic solvent for substituent effects. *Table 3

Contains dissociative substituent

No dissociative substituent

4. Adjust the concentration of the organic solvent for effects from dissociative substituents.

Complete

Complete

1. Select a compound from Figure 1 with a similar basic skeleton to the target sample. Select the best organic solvent concentration.

Table 1. Retention time of the basic chemical skeleton

Basic skeleton	Column	Retention Time Under Different Methanol Concentrations (min)						
		80%	70%	60%	50%	40%	30%	20%
Benzene	5C ₁₈ -MS-II	-	4	7	11	20	-	-
	5C ₁₈ -AR-II	-	4	7	13	23	-	-
Naphthalene	5C ₁₈ -MS-II	5	8	18	-	-	-	-
	5C ₁₈ -AR-II	5	10	22	-	-	-	-
Diphenyl	5C ₁₈ -MS-II	8	13	-	-	-	-	-
	5C ₁₈ -AR-II	7	15	-	-	-	-	-
Quinoline	5C ₁₈ -MS-II	-	-	-	-	6	11	-
	5C ₁₈ -AR-II	-	-	-	-	8	17	-
Caffeine	5C ₁₈ -MS-II	-	-	-	-	-	4	9
	5C ₁₈ -AR-II	-	-	-	-	-	4	9

Column: COSMOSIL 4.6 mm I.D. × 150 mm Flow Rate: 1.0 ml/min Detection: UV 254 nm

2. Adjust the organic solvent concentration considering effects of heteroatoms as shown in Table 2.

Table 2. Organic solvent concentration adjustment due to hetero rings or polycyclic aromatics

Hetero rings, polycyclic aromatics	Sample	5C ₁₈ -MS-II	5C ₁₈ -AR-II
Conjugate ring (1 ring)	Benzene	+10%	+10%
Heterocyclic heteroatom	S (1 atom)	±0%	±0%
	O (1 atom)	-5%	-5%
	N (1 atom)	-20%	-10%
Carbonyl group (1 group)	Quinone	-5%	-5%
Double Bond (1 bond)	-	-5%	-5%

3. Adjust the concentration of organic solvent considering effects from substituents as shown in Table 3.

Table 3. Organic solvent concentration adjustment due to substituents

Substituent	Methanol Concentration		Substituent	Methanol Concentration
	5C ₁₈ -MS-II	5C ₁₈ -AR-II		
-F	0	0	-CH ₂ - (Alkyl chain) MeOH concentration of basic skeleton:	100-90% +10% for every 4 carbons 90-80% +10% for every 3 carbons 80-60% +10% for every 2 carbons < 60% +10% for each carbon
-Cl	+10%	+10%		
-Br	+10%	+10%		
-I	+20%	+15%		
-CONH ₂	-40%	-40%		
-COCH ₃	-10%	-10%		
-COOCH ₃	0	0		
-OCH ₃	0	0	Phenyl group MeOH concentration of basic skeleton:	100-90% +5% for each phenyl group 90-60% +10% for each phenyl group < 60% +20% for each phenyl group
-CHCH ₂ O	-10%	-10%		
-CH ₂ OH	-30%	-30%		
-OH	-30%	-30%		
-NO ₂	-10%	-5%		
-CN	-20%	-15%		
-NH ₂	-40%	-30%		
-SCH ₃	+10%	+10%		

Column: COSMOSIL 4.6 mm I.D. × 150 mm

Flow Rate: 1.0 ml / min Detection: UV 254 nm

* Effect may differ somewhat due to the position of the substituent.

4. Compounds with dissociative substituents are extremely sensitive to slight pH changes. Maintain consistent mobile phase pH to obtain reproducible data. Table 4 shows the influence of acidic (pH 2) and neutral (pH 7) conditions on methanol concentration (for approximately the same retention time).

Table 4. Effect of dissociative substituent on organic solvent concentration

Dissociable Substituent	Change of Methanol Concentration (pH 2)	Change of Methanol Concentration (pH 7)
-COOH	-10~-20%	-30~-40%
-SO ₃ H	-20~-40%	-30~-40%
-PO ₄ H ₂	-20%	-50%
-BO ₂ H ₂	-20%	-20%
-NH ₂ (molecular type)	-60%	-10%
-NH ₂ (cyclic amine)	-50~-60%	-10~-20%
-NH ₂ (ionic type)	-	-40~-50%

Column :COSMOSIL 5C₁₈-MS-II, 4.6 mm I.D. x 150 mm
Buffer pH2 :20mmol/l H₃PO₄
pH7 :20mmol/l H₃PO₄/Na₂HPO₄=2/3
Flow Rate :1.0 ml/min
Detection :UV 254 nm

● Examples

Column: COSMOSIL 5C₁₈-MS-II 4.6 mm I.D. × 150 mm

(1) 5-Benzyloxyindole

<Calculation> Basic skeleton: Naphthalene-like + (hetero ring w/ N)
 =70%+ (-20%)
 =50%

Substituent: (Phenyl) + (-OCH₂- [equal to -OCH₃])
 =(+10%) + (+0%)

Basic skeleton + Substituent = 50% + (+10%) = 60%

<Result> 60% Methanol (Methanol:Water=60:40)

Retention time: 13.7 min

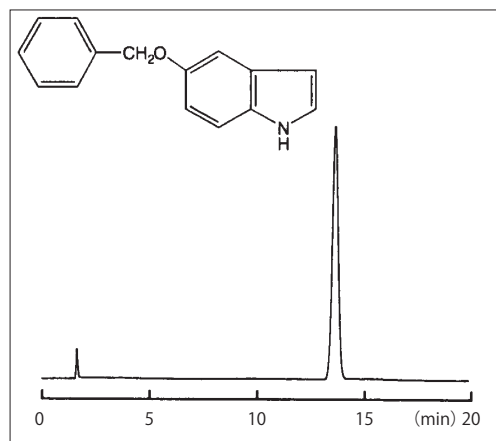

Figure 2. Analysis of 5-Benzyloxyindole

(2) Homovanillic Acid

<Calculation> Basic skeleton: Benzene = 60%
 Nondissociative substituent: (-OH) + (-OCH₃) + (-CH₂)
 =(-30%) + (0%) + (+10%)
 = -20%

Dissociative substituent: -COOH = -10~-20% (pH 2)
 -30~-40% (pH 7)

Basic skeleton + Substituent = Acidic pH (2): 30-20%
 Neutral pH (7): 10-0%

<Result> (pH 2) 30% Methanol: Retention time=5.7 min
 20% Methanol: Retention time=11.7 min
 (pH 7) 10% Methanol: Retention time=4.0 min
 0% Methanol: Retention time=12.1 min

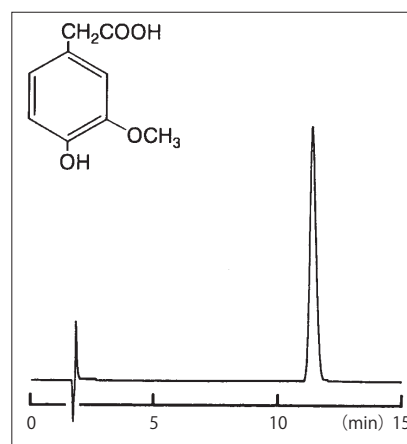
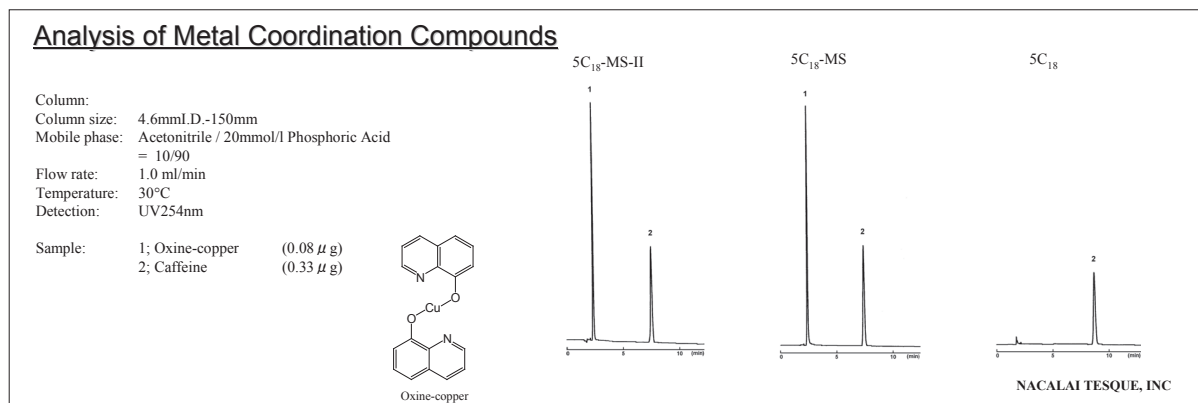

Figure3. Analysis of 20% Methanol (pH 2)

* Actual results may have about ±10% error in organic solvent concentration due to unique properties of the analyte.

1) New-Type COSMOSIL (5C₁₈-MS-II) vs. Old-Type COSMOSIL (5C₁₈ and 5C₁₈-MS)Analysis of Metal Coordination Compounds

Metal coordination compounds, (e.g., oxine-copper) were not eluted from COSMOSIL 5C₁₈ because its silica gel contains a high level of metal impurities. COSMOSIL 5C₁₈-MS and 5C₁₈-MS-II can separate the same metal coordination compounds because they are packed with high-purity (99.99%) silica gel.

Analysis of Basic Compounds

COSMOSIL 5C₁₈-MS-II shows better performance for basic compounds than COSMOSIL 5C₁₈-MS because the new product is treated with improved endcapping.

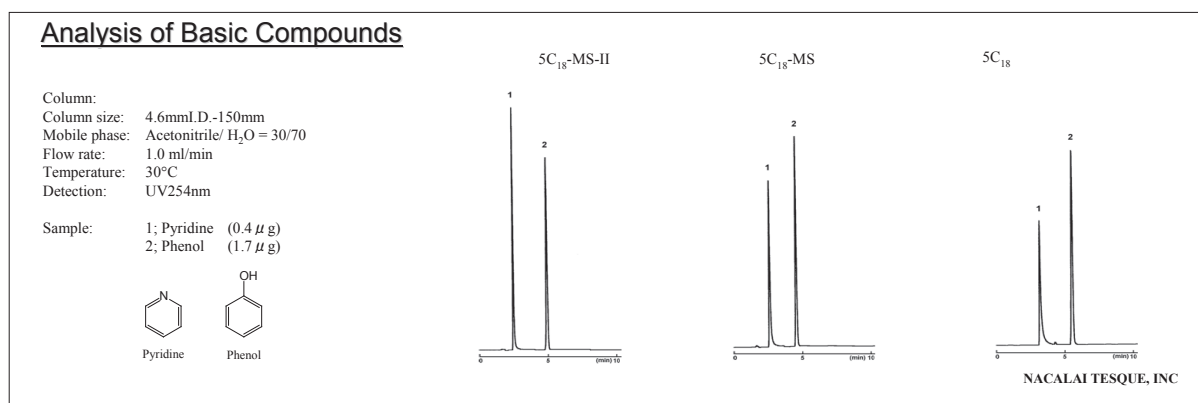
Selectivity

There is little difference between COSMOSIL 5C₁₈, 5C₁₈-MS and 5C₁₈-MS-II regarding selectivity. The same analytical conditions used for the old columns can be transferred to COSMOSIL 5C₁₈-MS-II without any modification.

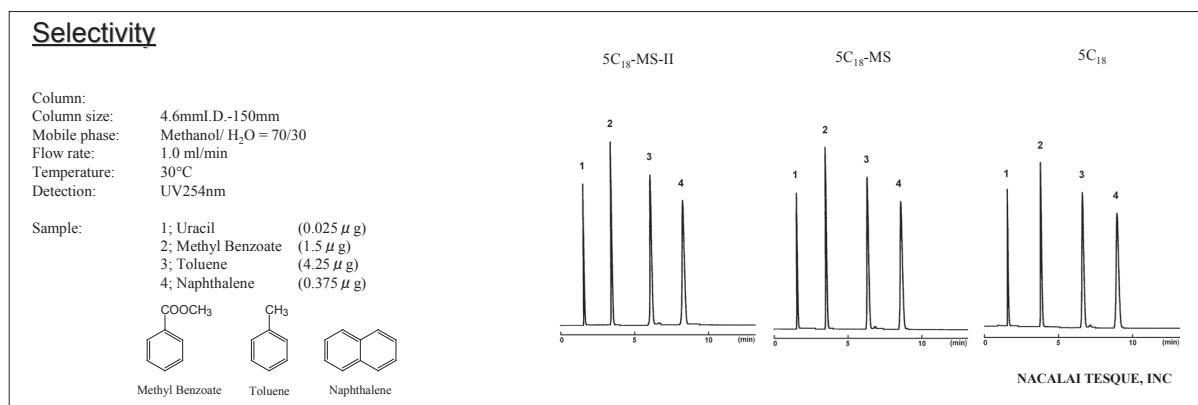

2) New-Type COSMOSIL (5C₁₈-AR-II) vs. Old-Type COSMOSIL (5C₁₈-AR)

Analysis of Metal Coordination Compounds

COSMOSIL 5C₁₈-AR-II shows better separation for metal coordination compounds (e.g., 8-Quinololinol) than COSMOSIL 5C₁₈-AR because of the high-purity silica gel.

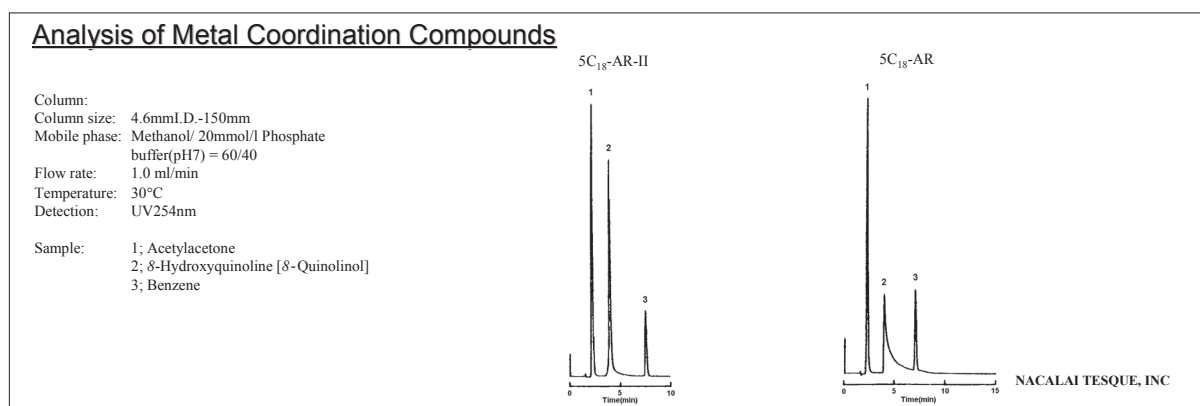

Acid Resistance

COSMOSIL 5C₁₈-AR-II shows superior acid resistance compared to 5C₁₈-AR.

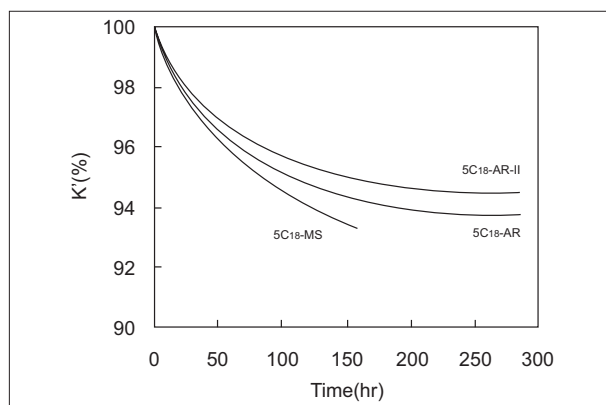

Degradation test with 0.1% Trifluoroacetic Acid at 60°C

Selectivity

The selectivity for non-dissociative organic compounds on COSMOSIL 5C₁₈-AR-II and COSMOSIL 5C₁₈-AR is identical because the carbon content of both columns is the same.

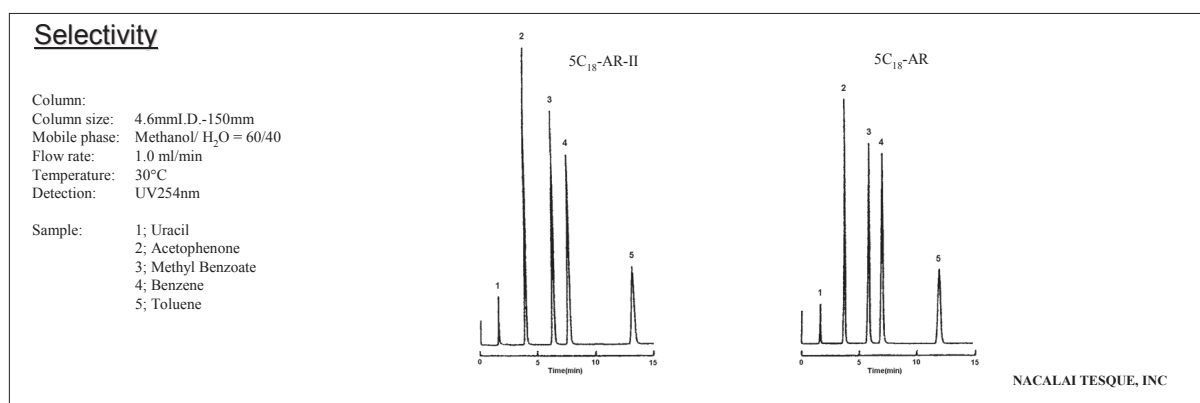

COSMOSIL 5C₁₈-MS-II and COSMOSIL 5C₁₈-AR-II are available in multiple gel lots to support method validation. We recommend using the newest COSMOSIL products for new applications.



Follow us!
@NacalaiTesque

Stay up to date and get useful tips!



Warranties and Disclaimers:

Nacalai Tesque warrants that its products shall conform to the description of such products as provided by Nacalai Tesque through its catalog, analytical data or other literature. Nacalai Tesque makes no other warranty, express or implied, as to the fitness of these products for any particular purpose. Nacalai Tesque shall not in any event be liable for incidental or consequential damages that may result from any use or failure of the products.

For more information on products and pricing, please contact your local distributor.

NACALAI TESQUE, INC.

Nijo Karasuma, Nakagyo-ku, Kyoto

604-0855 JAPAN

TEL : +81 (0)75 251 1730

FAX : +81 (0)75 251 1763

E-mail : info.intl@nacalai.com

www.nacalai.com

Nacalai USA, Inc.

10225 Barnes Canyon Rd., Suite A 103

San Diego, CA 92121

TEL : (858) 404-0403

FAX : (858) 404-0408

E-mail : info@nacalaiusa.com

www.nacalaiusa.com