

FLUIDIC PRODUCTS AND INFORMATION

BIOTECH is a Premium Distributor
for IDEX Health & Science

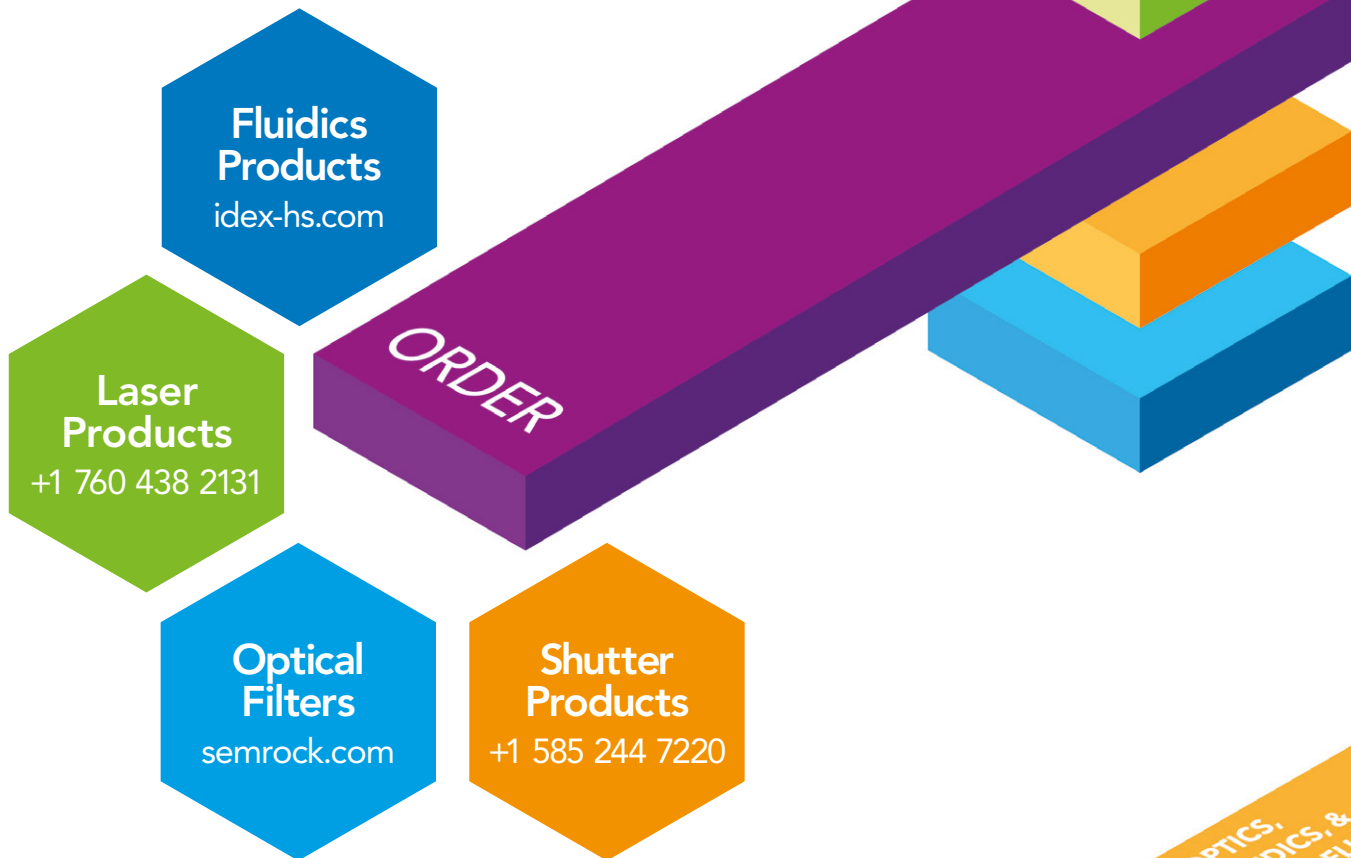

Intelligent Solutions for Life™
Fluidics | Optics | Consumables | Assemblies



For your information, our U.S. Federal Taxpayer Identification number is 01-0736657; European Taxpayer Identification number is DE 146581180.

ORDER PROCESSING/ SHIPPING

Orders placed on our website process and ship as specified during the checkout process. Orders that are placed via fax/email will be subject to a \$100 minimum order quantity and typically process within one business day and ship within two business days. Customers who have established contract pricing terms must place catalog orders directly with their Customer Service representative.

All shipments are FCA unless otherwise noted. For orders not placed via our website, shipping charges will be prepaid and added to the invoice. Or, if requested, we will charge your carrier account number.

TERMS

Credit cards are accepted for orders placed within the United States. Purchase orders may also be used by qualified customers. No international credit card payment is possible. No international shipments are possible. For terms and conditions of sale please visit www.idex-hs.com/legal-notices. Terms and prices are subject to change without notice.

RETURN OF MATERIALS

Returns must be authorized in advance. Please contact us within 30 days of purchase for your Returns Material Authorization (RMA) Number. A restocking fee may apply. To request a Return Materials Authorization for IDEX Health & Science products visit www.idex-hs.com/return.

Product purchased through a Distributor must be returned directly to that Distributor. Please contact them for Return Material Authorization procedures.

DIRECT FROM OUR GLOBAL DISTRIBUTION NETWORK

IDEX Health & Science has established relationships with a global network of Distributors that offer outstanding product support and assistance. In order to meet our customer's needs, and the demands of being a global supplier, we have come to rely on our authorized Distributors to provide value-added service and support of our products. While we are happy to take your order directly, we encourage you to contact your local IDEX Health & Science Distributor.

HOW TO FIND A LOCAL DISTRIBUTOR FOR FLUIDICS PRODUCTS

For a complete distributor listing please visit www.idex-hs.com/distributors or email:

US:
IHSOrders@idexcorp.com

Europe:
CustomerService.hsEurope@idexcorp.com

Asia:
CustomerService.hsAsia@idexcorp.com

Our customer service team will help you contact a distributor in your area.

HOW TO FIND A LOCAL DISTRIBUTOR FOR SEMROCK PRODUCTS

For a complete distributor listing please visit www.semrock.com/international-distributors.aspx

The products in this catalog are intended for use with analytical, biotechnology and diagnostic equipment and accessories. THE MANUFACTURERS OF THE PRODUCTS IN THIS CATALOG SHALL HAVE NO LIABILITY WHATSOEVER DUE TO ANY MISUSE OF THEIR PRODUCTS. Of course, the safe use of our products depends on our customers, since it is you who select and control the protective gear and safety procedures used, as well as the pressures, temperatures, solvents, samples, ventilation, and other variables. Product and material performance ratings are provided as guides only. Individual field tests should be performed by customers to determine safe operating parameters given your particular procedures and use. IDEX Health & Science facilities are certified ISO 9001.



WE HAVE A NEW VISION FOR THE WORLD OF FLUIDICS & OPTICS

As your trusted partner in life science instrument development, we continue to invest in leading technologies and capabilities to solve your most demanding challenges.

For this reason, we have strategically integrated innovative optical companies, like Semrock and Melles Griot, to bring you a newly enhanced portfolio of state-of-the-art components and capabilities that are unrivaled in breadth, performance, quality and design.

Now, as *the* global authority in fluidics and optics, we deliver a complete spectrum of highly engineered solutions, and more powerful platforms than ever before.

IDEX
HEALTH & SCIENCE

Our vision of the complete path goes far beyond just meeting your needs — it anticipates them, with *intelligent solutions for life.*

GLOBAL PREMIUM DISTRIBUTOR FOR IDEX



GLOBAL PREMIUM DISTRIBUTOR

Biotech AB in Sweden/Europe (Headquarter),
Biotech USA LLC and Bionik Inc Japan are Global
Premium Distributors of IDEX Health & Science.

FAST DELIVERY

With several weekly shipments from IDEX manufacturing sites in US, together with our extensive Swedish warehouse, we support the European & Global market with short delivery times as well as fast answers on technical questions and a high level of flexibility.

LOCAL DISTRIBUTORS

In almost every European country we work in close co-operation with local distributors that supports you with excellent daily service, long experience and highest level of technical assistance.

FULL IDEX ASSORTMENT

With the full IDEX assortment of components for fluidic systems along with our long experience and know-how in the field we can assure you to always do our very best in supplying you with excellent solutions and products. Customized OEM solutions, especially in the field of degassing, is something we offer to instrument manufacturers globally.



BIOTECH + IDEX = EVERYTHING FOR THE LAB

KNOW-HOW AND A WIDE ASSORTMENT

As Global Premium Distributor for IDEX we have special know-how about their assortment and can provide you with the right mix of products for a successful lab.

We have cutting edge knowledge to tailor the system for laboratories' specific needs for fluidic handling. You will find a wide range of products to suit every possible flow rate and type of fluid. In this field, we offer a number of well-known brands, such as Systec, Upchurch, Rheodyne and Isolation Technologies - all to give you the best solutions.

INNOVATIVE PRODUCTS FOR FLUIDIC SYSTEMS



www.biotech.se



12 FLUIDIC CONNECTIONS

13	TUBING	30	FITTINGS	50	Fittings Tools
16	PEEK Tubing	32	One-Piece Fingertight Fittings	52	Tubing Sleeves
19	Stainless Steel Tubing	33	Stainless Steel Fittings	55	Plugs & Caps
22	PEEKsil™ Tubing	34	MicroTight® Fittings	56	Large Bore Fittings
24	PFA Tubing	35	Two-Piece Fingertight Fittings	57	VHP Micro Fittings
26	FEP Tubing	36	Two-Piece SealTight™ Fingertight Fittings	58	VHP PK Fittings
27	ETFE Tubing	37	NanoTight™ Fittings & Sleeves	59	Stainless Steel VHP Fittings
28	Tools	38	LiteTouch® Fittings	60	Reusable VHP Fittings
		39	Super Flangeless™ Fittings	61	Assorted Fittings Kits
		42	VacuTight™ Fittings		
		43	Metric Flangeless Fittings		
		44	Flanged Fittings		
		45	Flangeless Fittings		
		48	MarvelX™		

How
To Order
Page 2

What's New
Page 8

Technical
Resources
Page 162

62	CONNECTORS	94	FILTERS & FRITS
63	Threaded Adapters	95	Stainless Steel Frits
67	High Pressure Mxing Tees	97	PEEK Frits
69	High Pressure Unons	99	Frit-in-a-Ferrule™
70	High Pressure PEEK Tees & Crosses	100	Bottom-of-the-Bottle™ Filters
71	High Pressure MicroTight® Unions	102	Inlet Solvent Filters
72	High Pressure Stainless Steel Tees & Crosses	103	Inline Filters
73	VHP Stainless Steel ZDV Unions	105	Precolumn Filters
74	VHP Tees & Crosses	107	Semi-Prep Filters
75	VHP MicroTight® Unions	108	Inline MicroFilters
77	MicroTight® Adapters	109	Mini MicroFilters
79	Accessories	110	Precolumn MicroFilters
80	NanoPort Assemblies	111	Bottle Caps
81	Low Pressure Manifolds	112	Bottle Cap Plugs
82	Low Pressure Bulkhead Unions		
83	Low Pressure Y Connectors		
84	Low Pressure Unions		
86	Low Pressure Tees & Crosses		
87	Quick Connect Luer Adapters		
89	LuerTight™ Fittings		
90	Barbed Connectors		

114 VALVES

119	Stand Alone Valve Products
120	Rapid Replacement Pods™
121	Manual Valves
124	Spare Parts
126	Valve accessories
127	Stainless Steel Sample Loops
128	PEEK Sample Loops
131	Suction Needle Adapter
132	Injection Port Adapters
133	Wrenches, Brackets, & Replacement Fittings

134 FLOW REGULATING VALVES

135	Inline Cartridge Check Valves
136	Standard 1/4-28 Inline Check Valves
137	Non-Metallic Check Valves
139	Quick-Stop Luer Inline Check Valve
140	Micro-Splitter Valves
141	Micro-Metering Valves
142	Shut-Off Valves

143 BACK PRESSURE REGULATORS

144	Ultra-Low Volume Back Pressure Regulators (BPRs)
145	Back Pressure Regulator Assemblies
146	Back Pressure Regulator Holders
147	Back Pressure Regulator Cartridges
148	Pressure Relief Valves

150 DEGASSERS

151	Debubblers
154	Full Stand Alone Degassing Systems

156 COLUMN HARDWARE

157	Guard Hardware
158	Guard Columns



MarvelX™

Advance Your Fluidic Systems with Next Generation UHPLC Connection Technology

Page 48

DEGASSER TUBING KIT

Ready-to-send kits with the tubing in need; attached, labeled and packed! and tubing for every application!

WE HELP YOU EVERY STEP OF THE WAY:

- Filters, tools, tubing markers and accessories
- Labeling with your logo and company details
- Packaging in boxes or plastic bags
- Long experience in this business

for your needs



WHAT'S

NEW



NEW VERSION!

- White color
- Better ventilation
- Full metal housing for improved chemical compatibility

Page 155

GO WITH A HIGH FLOW INTRODUCING THE ALL NEW DEGASI PREP+

in-line Degasser, for Organic Solvents

Page 155

**HIGH
FLOW RATE**
75 ml/min
Per channel



ORGANIC
SOLVENTS

CATALOG HINTS



Bio

Biocompatible Products

Look for components with the blue "Bio" icon, which designates products that use materials anticipated to maintain the integrity and improve the analysis of biological samples in your intended applications.



Navigation Breadcrumbs

Quickly pinpoint any product or product family within this catalog to the same navigation path each product is categorized on our website. Look to the bottom of every product page for easy-to-follow breadcrumbs to locate specific categories and sub-categories in sequential order, then visit: www.idex-hs.com.

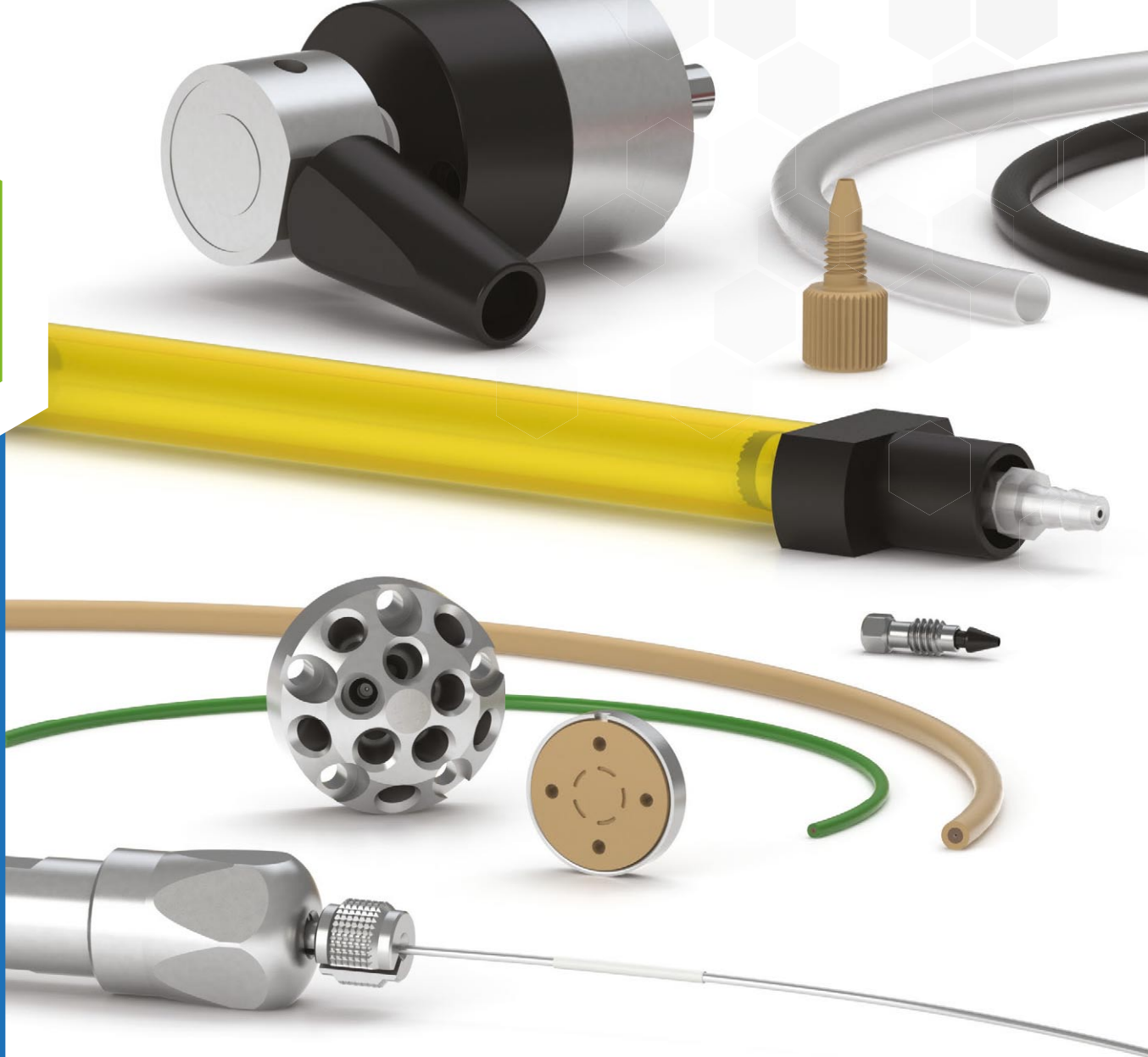

Welcome to Fluidics

We are the premier provider of intelligently engineered fluidic components, assemblies, and integrated solutions for a wide range of life science applications that require precise control and measurement.

Perform precise sample preparation and analysis with our premium fluidic solutions.





12 FLUIDIC CONNECTIONS

114 VALVES

150 DEGASSERS

156 COLUMN HARDWARE



Fluidic Connections

IDEX Health & Science has developed a comprehensive line of standard and custom tubing, connectors, fittings, and flow control devices that meet the increasingly demanding requirements of today's high performance analytical fluidic systems. We feature specialty, high-performance polymers and distinct materials designed to work with your system needs. We offer unique products such as biocompatible PEEK-lined stainless steel tubing as well as an assortment of high pressure and fluoropolymer tubing. All of our fittings, filters and frits and connectors come in a variety of materials and styles. We can provide micro and nano-scale dimensions and well as custom forming, assembly and kitting. We also offer our RI detector that provide high resolution and low dispersion detection for HPLC applications.

13

TUBING

30

FITTINGS

62

CONNECTORS

94

FILTERS & FRITS

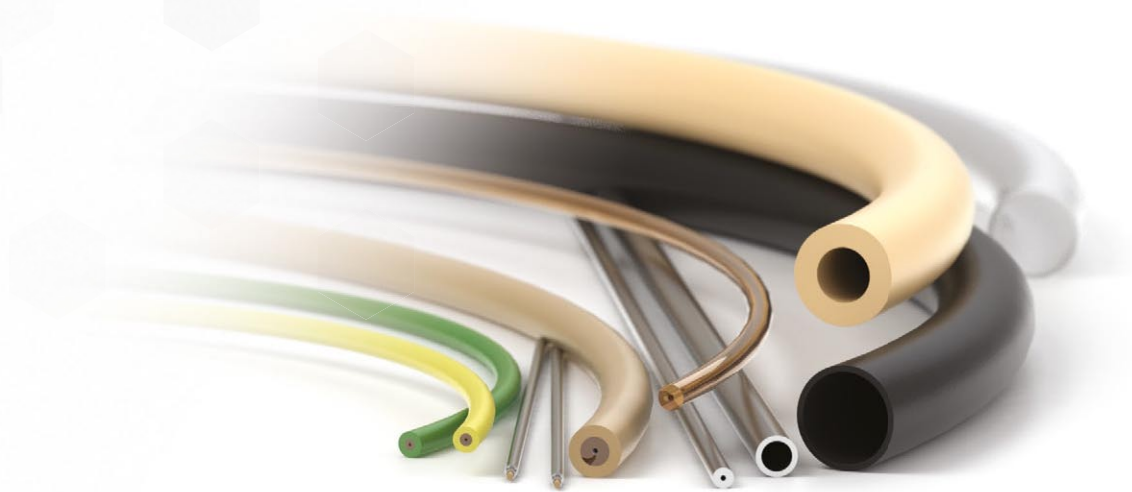

TUBING

Our high quality, versatile tubing is offered in a variety of materials and styles to meet your system requirements. Our high pressure tubing includes biocompatible PEEK selections and well as seamless, pre-cut stainless steel. Our fluoropolymer tubing is constructed with genuine Teflon™ FEP and PFA resin, and our unique High Purity PFA. Many of our tubing options are color coded for easy detection and some are translucent making it easy to view the fluid pathway. Our tubing is manufactured to precise tight tolerances to ensure dependable product consistency.

- 16** HIGH PRESSURE TUBING
- 24** FLUOROPOLYMER TUBING
- 28** TOOLS

TUBING OVERVIEW & FUNCTIONS

HIGH PRESSURE TUBING



TUBING:	PEEK	Capillary PEEK	Fused Silica	Stainless Steel	PEEKsil™
Page	16	16	16	19	22
Description	<p>Biocompatible, chemically inert to most commonly used solvents, PEEK tubing is flexible, offers a very smooth internal surface, and can be easily cut to desired lengths.</p> <ul style="list-style-type: none"> Great alternative for stainless steel tubing in high pressure applications Many sizes available in color scheme to help identify ID 	<p>All the benefits of larger sized PEEK tubing, while serving as an excellent alternative to more traditional fused silica and stainless steel capillary tubing. Capillary PEEK tubing is available in a wide range of micro and nano-scale inner diameters.</p> <ul style="list-style-type: none"> Available in common capillary tubing sizes with tight tolerances on OD and ID Tubing sleeves available for capillary tubing connections 	<p>Because of the tight tolerances of fused silica's inner diameters, this tubing is used for micro-scale analyses such as micro and nano-HPLC and capillary electrophoresis.</p> <ul style="list-style-type: none"> Most commonly used OD and ID sizes available High quality, polyimide-clad fused silica Offered in convenient, two meter lengths 	<p>Seamless, pre-cut 316 stainless steel tubing meets the exacting requirements of today's analyses. Thorough preparation guarantees that the tubing is truly ready-to-use, with flat-burr-free ends and a clean finish.</p> <ul style="list-style-type: none"> Wide selection of outside and inside diameters and lengths Pre-cut to ensure burr-free, flat connections Many sizes feature a color-coded band for easy ID identification 	<p>PEEKsil is mechanically strong and has ideal characteristics for sealing with metal or polymer fittings.</p> <ul style="list-style-type: none"> Comprised of high quality fused silica sheathed by PEEK tubing Excellent chemical compatibility Very tight manufacturing tolerances Good replacement for stainless steel, PEEK, or standard fused silica

HIGH PRESSURE TUBING SPECIFICATIONS					
OD (outside diameter)	1/32" (785 µm), 1/16" (1.55 mm), 1/8" (3.2 mm)	0.0145" (360 µm), 1/32" (785 µm), 0.020" (0.5 mm)	0.0145" (360 µm)	1/32" (785 µm), 1/16" (1.55 mm), 1/8" (3.2 mm)	0.0145" (360 µm), 1/32" (785 µm), 1/16" (1.55 mm)
ID (inside diameter)	0.001" (25 µm)– 0.080" (2.0 mm)	0.001" (25 µm)– 0.020" (0.50 mm)	0.0008" (20 µm)–0.006" (150 µm)	0.004" (100 µm)– 0.080" (2.0 mm)	0.001" (25 µm)– 0.012" (300 µm)
Operating Temp	-51 to 100 °C	-51 to 100 °C	-51 to 100 °C	-51 to 289 °C	-51 to 100 °C
Pressure Rating	500–10,000 psi (34–690 bar)	2,000–5,000 psi (138–345 bar)	N/A*	N/A*	10,000 psi (690 bar)
Typical Tolerances	±0.001" (25 µm) for 1/16" OD tubing; ±0.003" (75 µm) for 1/8" OD tubing	±0.0005" (12.5 µm)	±0.0004" (10 µm)	±0.001" (25 µm) for 1/16" OD tubing; ±0.003" (75 µm) for 1/8" OD tubing	±0.0004" (10 µm)
Refractive Index (Clarity)	Opaque	Opaque	1.78	Opaque	Opaque
pH Range	0–14	0–14	0–10	1–14	0–10
Sterilization Techniques	Gamma irradiation; ethylene oxide; thermal	Gamma irradiation; ethylene oxide; thermal	Ethylene oxide; thermal	Gamma irradiation; ethylene oxide; thermal	Ethylene oxide; thermal
Autoclavable?	Y	Y	Y	Y	Y

*The manufacturer of this tubing or material does not publish this specification.

TUBING OD SIZES

Please use this table as a reference tool to help quickly locate within this chapter the appropriate OD size tubing for your application.

1 mm
OD



Page(s)
26

2 mm
OD



Page(s)
26

3 mm
OD



Page(s)
26

FLUOROPOLYMER TUBING



TUBING:	PFA	High Purity PFA	360 µm High Purity PFA	FEP	ETFE
Page	24	24	24	26	27
Description	<p>Offers excellent chemical compatibility, plus due to its inner surface smoothness, PFA tubing tends to be more translucent than PTFE tubing.</p> <ul style="list-style-type: none"> Offers higher purity and enhanced translucence when compared with other fluoropolymer tubes Great for more critical, low pressure applications 	<p>This polymer tubing is manufactured from a premium grade of PFA — one of the most contaminant-free polymers on the market.</p> <ul style="list-style-type: none"> Offers chemical stability, mechanical strength, and purity for applications such as medical, diagnostic, pharmaceutical, biotechnology, and semiconductor Excellent replacement for PTFE where gas permeability and surface texture are issues Clarity of tubing makes PFA an excellent choice for monitoring fluid movement 	<p>This tubing offers excellent chemical compatibility, transparency, very low contaminant levels and is available in the most commonly-used outside diameter for capillary tubing applications.</p> <ul style="list-style-type: none"> Replacement for capillary tubing in low pressure applications where excellent chemical compatibility is required Tubing sleeves available for capillary tubing connections 	<p>FEP tubing is a great alternative to traditional PTFE tubing, desirable for use because it is chemically inert to most solvents, easy to cut, and translucent for easy monitoring of solutions passing through.</p> <ul style="list-style-type: none"> Great for general, low pressure applications Many sizes available in multiple colors for easy identification Tight manufacturing tolerances to ensure product consistency 	<p>ETFE is chemically inert and more suitable for higher pressure applications (when using aqueous mobile phases) than PTFE, FEP, and PFA. Additionally, because ETFE is more rigid than PTFE, FEP, and PFA, this tubing better resists inner diameter collapse.</p> <ul style="list-style-type: none"> Excellent solvent resistance More durable and less gas permeable than PTFE, FEP, and PFA Operating temperatures up to 80 °C

FLUOROPOLYMER TUBING SPECIFICATIONS

OD (outside diameter)	1/16" (1.55 mm), 1/8" (3.2 mm)	1/16" (1.55 mm), 1/8" (3.2 mm), 3/16" (4.8 mm), 1/4" (6.35 mm)	0.0145" (360 µm)	1/16" (1.55 mm), 0.080" (2.0 mm), 0.118" (3.0 mm), 1/8" (3.2 mm), 0.157" (4.0 mm), 3/16" (4.8 mm), 1/4" (6.35 mm), 5/16" (7.94 mm)	1/16" (1.6 mm), 1/8" (3.2 mm), 1/4" (6.35 mm)
ID (inside diameter)	0.020" (0.50 mm)– 0.062" (1.55 mm)	0.020" (0.50 mm)– 0.188" (4.80 mm)	0.002" (50 µm)– 0.006" (150 µm)	0.003" (0.075 mm) – 0.250" (6.35 mm)	0.010" (0.25 mm)– 0.188" (4.80 mm)
Operating Temp	-51 to 80 °C	-51 to 80 °C	-51 to 80 °C	-51 to 50 °C	-51 to 80 °C
Pressure Rating	500–2,000 psi (34–138 bar)	250–2,000 psi (17–138 bar)	1,750–3,500 psi (121–241 bar)	2,500–4,000 psi (172–276 bar)	250–4,000 psi (17–276 bar)
Typical Tolerances	±0.001" (25 µm) for 1/16" OD tubing; ±0.003" (75 µm) for 1/8" OD tubing	±0.001" (25 µm) or 1/16" OD tubing	±0.0005" (12.5 µm)	±0.001" (25 µm) for 1/16" OD tubing; ±0.003" (75 µm) for 1/8" OD tubing	±0.001" (25 µm) for 1/16" OD tubing; ±0.003" (75 µm) for 1/8" OD tubing
Refractive Index (Clarity)	1.34	1.34	1.34	1.338	1.4
pH Range	0–14	0–14	0–14	0–14	0–14
Sterilization Techniques	Ethylene oxide; thermal	Gamma irradiation; ethylene oxide; thermal	Gamma irradiation; ethylene oxide; thermal	Ethylene oxide; thermal	Ethylene oxide
Autoclavable?	Y	Y	Y	Y	Y

**360 µm
OD**

Page(s)
18, 24

**1/32"
OD**

Page(s)
18, 20, 23

**1/16"
OD**

Page(s)
18, 23, 21,
26, 27

**1/8"
OD**

Page(s)
18, 21, 26, 27

**3/16"
OD**

Page(s)
26

**1/4"
OD**

Page(s)
26

**5/16"
OD**

Page(s)
26



PEEK Tubing

- › 1/16" or 1/8" outside diameter available
- › Biocompatible, inert, and easily cut
- › Great for high pressure applications
- › Maximum continuous use temperature: 100 °C

Our PEEK (polyetheretherketone) polymer tubing is biocompatible, chemically inert to most solvents, and can be used to replace stainless steel tubing in most liquid analytical systems. Unlike stainless steel tubing, PEEK tubing is flexible and can be easily cut to desired lengths.

PEEK tubing has a very smooth internal surface, which causes less turbulence than similarly sized metal tubing, contributing to improved resolution of sample bands. Of all our polymer tubing materials, PEEK is the least permeable to gas (see material properties on our website: www.idex-hs.com).

In addition, much of our 1/16" OD tubing is color-coded so different IDs are easily identified. Our proprietary extrusion process ensures color permanence in our tubing.

Our 5' length tubing is rough cut to approximately 5'1". A trim cut should be made before use, especially for smaller ID tubing. PEEK tubing can be cut easily with a razor blade. However for an improved cut, try our Tubing Cutters on page 28.



Capillary PEEK Tubing

- › 360 µm or 1/32" outside diameter available
- › IDs as small as 25 µm (0.001")

Capillary PEEK tubing offers all the benefits of larger sized PEEK tubing, while serving as an excellent alternative to more traditional fused silica and stainless steel capillary tubing (see Application Note, right). The capillary tubing can be coupled to many of the products in the Connectors chapter (starting on page 62) and to some of the valves in the Valves chapter (starting on page 114).



Fused Silica Tubing

- › Five inner diameters with most common capillary outside diameter, 360 µm
- › Cut in convenient lengths, up to 2 m

These products are manufactured from synthetic fused silica with a polyimide coating.

 NOTE

Because the thru-hole of our 25 µm ID PEEK tubing is very small, it is possible for some fittings to cause the ID to become occluded. Please use caution, especially with wrench-tightened fittings. For more information, please contact IDEX Health & Science or your local Distributor directly.

 APPLICATION NOTE

What Size PEEK Tubing Should I Use?

- › It is usually safe to use 1/16" OD x 0.010" ID tubing throughout an analytical HPLC system. With a 0.010" ID, the pressure drop across most tubing lengths is negligible, and the ID is small enough to minimize band broadening.
- › High pressure semi-prep LC systems will most likely use 1/8" OD tubing.
- › Use our 1/32" OD tubing for the high pressure flow path of some microbore HPLC systems.
- › Choose 360 µm OD tubing for most capillary systems.
- › PEEK tubing is also available by the inch. Contact your local Distributor or IDEX Health & Science directly for pricing information.

 APPLICATION NOTE

- › An independent study conducted by a major pharmaceutical company indicated LC-MS chromatographic performance could be improved in some cases by switching the post-column transfer line from fused silica to PEEK polymer tubing. The switch dramatically reduced peak tailing and eliminated the degradation of peak symmetry as injection volume was reduced. For more information, please contact us or order the "Improved LC-MS Results Study" from the "Literature Request" section of our website at www.idex-hs.com.
- › To straighten PEEK polymer tubing, first choose a piece of stainless steel tubing with an inner diameter slightly larger than the OD of your tubing and with an appropriate length for the PEEK tubing you wish to straighten. For instance, for 1/16" OD PEEK tubing with a length of 10", choose our U-825 tubing (stainless steel, 1/8" OD x 0.080" ID x 25 cm long, page 19). Slip your PEEK tubing into the stainless steel tubing. Place this "sleeved" tubing into an oven and bake at 425 °F (218 °C) for 30 minutes or 350 °F (177 °C) for 60 minutes. Allow the sleeved tubing to return to room temperature naturally (i.e., do not quench it with water). Once cooled, remove the PEEK tubing from the stainless steel sleeve and inspect it for straightness. If needed, repeat the process until the desired straightness is achieved.

 SPECIFICATIONS & DETAILS

Tubing OD	Tubing ID	OD Tolerance	ID Tolerance
PEEK TUBING SPECIFICATIONS			
1/16"	25 µm	±0.001" (25 µm)	±0.0005" (12.5 µm)
1/8"	All	±0.003" (75 µm)	±0.003" (75 µm)
CAPILLARY PEEK TUBING SPECIFICATIONS			
360 µm	All	±0.0005" (12.5 µm)	±0.0005" (12.5 µm)
1/32"	All	±0.0005" (12.5 µm)	±0.0005" (12.5 µm)
FUSED SILICA TUBING, 360 µm OD			
360 µm	20 µm (0.0008")	±0.0004" (10 µm)	±0.00008" (2 µm)
360 µm	50 µm (0.002") and 75 µm (0.003")	±0.0004" (10 µm)	±0.00012" (3 µm)
360 µm	100 µm (0.004") and 150 µm (0.006")	±0.0004" (10 µm)	±0.00016" (4 µm)

PEEK Tubing (Cont.)

PEEK Tubing

Part No.	ID	Color	Max. Pressure	Qty.
PEEK TUBING, 1/16" OD				
1560	0.0025" (65 µm) ID x 5' (1.5 m)	Natural	7,000 psi (483 bar)	ea.
1560L	0.0025" (65 µm) ID x 50' (15 m)	Natural	7,000 psi (483 bar)	ea.
1560XL	0.0025" (65 µm) ID x 100' (30 m)	Natural	7,000 psi (483 bar)	ea.
1560M	0.0025" (65 µm) ID x 1,000' (304 m)	Natural	7,000 psi (483 bar)	ea.
1561	0.004" (0.10 mm) ID x 5' (1.5 m)	Black	7,000 psi (483 bar)	ea.
1561L	0.004" (0.10 mm) ID x 50' (15 m)	Black	7,000 psi (483 bar)	ea.
1561XL	0.004" (0.10 mm) ID x 100' (30 m)	Black	7,000 psi (483 bar)	ea.
1561M	0.004" (0.10 mm) ID x 1,000' (304 m)	Black	7,000 psi (483 bar)	ea.
1535	0.005" (0.125 mm) ID x 5' (1.5 m)	Red	7,000 psi (483 bar)	ea.
1535L	0.005" (0.125 mm) ID x 50' (15 m)	Red	7,000 psi (483 bar)	ea.
1535XL	0.005" (0.125 mm) ID x 100' (30 m)	Red	7,000 psi (483 bar)	ea.
1535M	0.005" (0.125 mm) ID x 1,000' (304 m)	Red	7,000 psi (483 bar)	ea.
1536	0.007" (0.175 mm) ID x 5' (1.5 m)	Yellow	7,000 psi (483 bar)	ea.
1536L	0.007" (0.175 mm) ID x 50' (15 m)	Yellow	7,000 psi (483 bar)	ea.
1536XL	0.007" (0.175 mm) ID x 100' (30 m)	Yellow	7,000 psi (483 bar)	ea.
1536M	0.007" (0.175 mm) ID x 1,000' (304 m)	Yellow	7,000 psi (483 bar)	ea.
1531	0.010" (0.25 mm) ID x 5' (1.5 m)	Natural	7,000 psi (483 bar)	ea.
1531L	0.010" (0.25 mm) ID x 50' (15 m)	Natural	7,000 psi (483 bar)	ea.
1531XL	0.010" (0.25 mm) ID x 100' (30 m)	Natural	7,000 psi (483 bar)	ea.
1531M	0.010" (0.25 mm) ID x 1,000' (304 m)	Natural	7,000 psi (483 bar)	ea.
1531B	0.010" (0.25 mm) ID x 5' (1.5 m)	Blue	7,000 psi (483 bar)	ea.
1531BL	0.010" (0.25 mm) ID x 50' (15 m)	Blue	7,000 psi (483 bar)	ea.
1531BXL	0.010" (0.25 mm) ID x 100' (30 m)	Blue	7,000 psi (483 bar)	ea.
1531BM	0.010" (0.25 mm) ID x 1,000' (304 m)	Blue	7,000 psi (483 bar)	ea.
1532	0.020" (0.50 mm) ID x 5' (1.5 m)	Orange	6,000 psi (414 bar)	ea.
1532L	0.020" (0.50 mm) ID x 50' (15 m)	Orange	6,000 psi (414 bar)	ea.
1532XL	0.020" (0.50 mm) ID x 100' (30 m)	Orange	6,000 psi (414 bar)	ea.
1532M	0.020" (0.50 mm) ID x 1,000' (304 m)	Orange	6,000 psi (414 bar)	ea.
1533	0.030" (0.75 mm) ID x 5' (1.5 m)	Green	4,000 psi (276 bar)	ea.
1533L	0.030" (0.75 mm) ID x 50' (15 m)	Green	4,000 psi (276 bar)	ea.
1533XL	0.030" (0.75 mm) ID x 100' (30 m)	Green	4,000 psi (276 bar)	ea.
1533M	0.030" (0.75 mm) ID x 1,000' (304 m)	Green	4,000 psi (276 bar)	ea.
1538	0.040" (1.00 mm) ID x 5' (1.5 m)	Natural	3,000 psi (207 bar)	ea.
1538L	0.040" (1.00 mm) ID x 50' (15 m)	Natural	3,000 psi (207 bar)	ea.
1538XL	0.040" (1.00 mm) ID x 100' (30 m)	Natural	3,000 psi (207 bar)	ea.
1538M	0.040" (1.00 mm) ID x 1,000' (304 m)	Natural	3,000 psi (207 bar)	ea.
PEEK TUBING, 1/8" OD				
1534	0.062" (1.55 mm) ID x 5' (1.5 m)	Natural	4,000 psi (276 bar)	ea.
1544	0.080" (2.00 mm) ID x 5' (1.5 m)	Natural	3,000 psi (207 bar)	ea.
CAPILLARY PEEK TUBING, 360 µm OD				
1574	25 µm (0.001") ID x 5' (1.5 m)	Natural	5,000 psi (345 bar)	ea.
1570	50 µm (0.002") ID x 5' (1.5 m)	Natural	2,000 psi (138 bar)	ea.
1571	100 µm (0.004") ID x 5' (1.5 m)	Red	2,000 psi (138 bar)	ea.
1572	150 µm (0.006") ID x 5' (1.5 m)	Yellow	2,000 psi (138 bar)	ea.
CAPILLARY PEEK TUBING, 1/32" OD				
1576	0.005" (0.125 mm) ID x 5' (1.5 m)	Red	5,000 psi (345 bar)	ea.
1576L	0.005" (0.125 mm) ID x 50' (15 m)	Red	5,000 psi (345 bar)	ea.
1576XL	0.005" (0.125 mm) ID x 100' (30 m)	Red	5,000 psi (345 bar)	ea.
1576M	0.005" (0.125 mm) ID x 1,000' (304 m)	Red	5,000 psi (345 bar)	ea.
1577	0.007" (0.175 mm) ID x 5' (1.5 m)	Yellow	5,000 psi (345 bar)	ea.
1577L	0.007" (0.175 mm) ID x 50' (15 m)	Yellow	5,000 psi (345 bar)	ea.
1577XL	0.007" (0.175 mm) ID x 100' (30 m)	Yellow	5,000 psi (345 bar)	ea.
1577M	0.007" (0.175 mm) ID x 1,000' (304 m)	Yellow	5,000 psi (345 bar)	ea.
1581	0.010" (0.25 mm) ID x 5' (1.5 m)	Blue	5,000 psi (345 bar)	ea.
1581L	0.010" (0.25 mm) ID x 50' (15 m)	Blue	5,000 psi (345 bar)	ea.
1581XL	0.010" (0.25 mm) ID x 100' (30 m)	Blue	5,000 psi (345 bar)	ea.
1581M	0.010" (0.25 mm) ID x 1,000' (304 m)	Blue	5,000 psi (345 bar)	ea.
1568	0.015" (0.40 mm) ID x 5' (1.5 m)	Natural	4,000 psi (276 bar)	ea.
1568L	0.015" (0.40 mm) ID x 50' (15 m)	Natural	4,000 psi (276 bar)	ea.
1568XL	0.015" (0.40 mm) ID x 100' (30 m)	Natural	4,000 psi (276 bar)	ea.
1568M	0.015" (0.40 mm) ID x 1,000' (304 m)	Natural	4,000 psi (276 bar)	ea.
1569	0.020" (0.50 mm) ID x 5' (1.5 m)	Orange	3,000 psi (207 bar)	ea.
1569L	0.020" (0.50 mm) ID x 50' (15 m)	Orange	3,000 psi (207 bar)	ea.
1569XL	0.020" (0.50 mm) ID x 100' (30 m)	Orange	3,000 psi (207 bar)	ea.
1569M	0.020" (0.50 mm) ID x 1,000' (304 m)	Orange	3,000 psi (207 bar)	ea.
FUSED SILICA TUBING, 360 µm OD				
FS-120	20 µm (0.0008") ID x 6.4' (2 m)	Natural	10,000 psi (690 bar)	ea.
FS-150	50 µm (0.002") ID x 6.4' (2 m)	Natural	10,000 psi (690 bar)	ea.
FS-175	75 µm (0.003") ID x 6.4' (2 m)	Natural	10,000 psi (690 bar)	ea.
FS-110	100 µm (0.004") ID x 6.4' (2 m)	Natural	10,000 psi (690 bar)	ea.
FS-115	150 µm (0.006") ID x 6.4' (2 m)	Natural	10,000 psi (690 bar)	ea.

Stainless Steel Tubing

- › Precut 316 stainless steel
- › Available ODs include 1/32", 1/16", and 1/8"
- › Color-coded banding for easy identification of the inner diameter

IDEX Health & Science seamless, precut stainless steel tubing is designed to meet the exacting requirements of today's analyses. We machine cut and polish each end, deburr the inside and outside edges, and passivate the tubing (please see the passivation information on this page). Finally, we flush reagent-grade isopropanol through each piece.

Our thorough preparation and cleaning procedure guarantees tubing that is truly ready-to-use, with flat, burr-free ends and a clean finish. This care is important in achieving zero-dead-volume connections and good chromatographic results.

We offer a variety of precut lengths as well as longer lengths (5' and 25') of some sizes. Cutting the tubing disturbs and roughens the tubing's end surface, so we recommend using our precut tubing whenever possible. If you need to cut tubing to custom lengths, we suggest you then passivate the tubing.



APPLICATION NOTE

- › Our 1/32" OD tubing is designed for enhanced flexibility in high pressure applications.
- › Standard 1/16" and 1/8" OD stainless steel tubing is suited for most analytical applications.



NOTE

PEEK polymer tubing can be used to replace stainless steel tubing in most liquid analytical systems. Unlike stainless steel tubing, PEEK tubing is biocompatible, flexible, and can easily be cut to desired lengths. See page 16. All Stainless Steel tubing longer than 1 m is coiled.

The Beauty of Precut Tubing

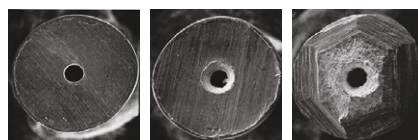

Precut tubing

Tubing cut by a commercially available tubing cutter

File cut tubing

Stainless Steel Tubing Passivation

Stainless steel is naturally self-passivating, forming an oxidized layer on newly created surfaces. IDEX Health & Science takes extra steps to ensure the chemical resistance of our stainless steel tubing by manually passivating before and after the tubing is cut into specified lengths (except in a few cases where size is prohibitive). In the precut stage, the internal wall is acid passivated and flushed. After the tubing is cut, deburred and polished, it is completely submerged in an acid passivation bath and again flushed clean. The table below summarizes the manual passivation steps performed for each size of our stainless steel tubing:

Tubing OD	Precut Passivation	Postcut Passivation
1/32"	All	All
1/16"	All	All, ex. 25' lengths
1/8"	None	All, ex. 3 & 5 m lengths

Stainless Steel Tubing (Cont.)



SPECIFICATIONS & DETAILS

- › Maximum Recommended Operating Temperature: 750 °F (399 °C).
- › Rockwell Hardness (B): Maximum of 95.
- › Meets ASTM A269 and A213.

Tubing OD	OD Tolerance	Tubing ID	ID Tolerance
1/32"	+0.002"/-0.000" (+50 µm/-0 µm)	All, except 0.004" (0.10 mm)	+0.000"/-0.002" (+0 µm/-50 µm)
1/32"	+0.002"/-0.000" (+50 µm/-0 µm)	0.004" (0.10 mm)	+0.002"/-0.000" (+50 µm/-0 µm)
1/16"	+0.002"/-0.000" (+50 µm/-0 µm)	All	±0.001" (25 µm)
1/8"	±0.003" (75 µm)	All	±0.003" (75 µm)



RELATED PRODUCTS

- › PEEK polymer tubing is available in all of these sizes, starting on page 16.



NOTE

Understanding the Maximum Pressure Value of Stainless Steel Tubing

Stainless steel is unique as a material. The Maximum Pressure value listed for each part number is the safe, continuous working pressure limit that IDEX Health & Science has assigned for the tubing. It reflects a safety margin before the tubing begins to "yield" — which is well below the tubing's "burst" pressure. For more information, contact IDEX Health & Science or your authorized Distributor.

Stainless Steel Tubing

Part No.	ID	Length	Color	Maximum Pressure	Qty.
STAINLESS STEEL, 1/32" OD					
U-1114	0.004" (0.10 mm)	2" (5 cm)	Red	19,300 psi (1,331 bar)	ea.
U-1115	0.004" (0.10 mm)	4" (10 cm)	Red	19,300 psi (1,331 bar)	ea.
U-1116	0.004" (0.10 mm)	8" (20 cm)	Red	19,300 psi (1,331 bar)	ea.
U-1117	0.004" (0.10 mm)	12" (30 cm)	Red	19,300 psi (1,331 bar)	ea.
U-1120	0.006" (0.15 mm)	2" (5 cm)	Yellow	19,300 psi (1,331 bar)	ea.
U-1122	0.006" (0.15 mm)	8" (20 cm)	Yellow	19,300 psi (1,331 bar)	ea.
U-1125	0.008" (0.20 mm)	2" (5 cm)	Clear	17,800 psi (1,227 bar)	ea.
U-1126	0.008" (0.20 mm)	4" (10 cm)	Clear	17,800 psi (1,227 bar)	ea.
U-1128	0.008" (0.20 mm)	12" (30 cm)	Clear	17,800 psi (1,227 bar)	ea.
U-1130	0.010" (0.25 mm)	2" (5 cm)	Blue	16,200 psi (1,117 bar)	ea.
U-1131	0.010" (0.25 mm)	4" (10 cm)	Blue	16,200 psi (1,117 bar)	ea.
U-1132	0.010" (0.25 mm)	8" (20 cm)	Blue	16,200 psi (1,117 bar)	ea.
U-1133	0.010" (0.25 mm)	12" (30 cm)	Blue	16,200 psi (1,117 bar)	ea.
U-1140	0.015" (0.40 mm)	2" (5 cm)	Green	12,300 psi (848 bar)	ea.
U-1141	0.015" (0.40 mm)	4" (10 cm)	Green	12,300 psi (848 bar)	ea.
U-1142	0.015" (0.40 mm)	8" (20 cm)	Green	12,300 psi (848 bar)	ea.
U-1143	0.015" (0.40 mm)	12" (30 cm)	Green	12,300 psi (848 bar)	ea.
U-1145	0.018" (0.45 mm)	2" (5 cm)	Black	10,000 psi (689 bar)	ea.
U-1146	0.018" (0.45 mm)	4" (10 cm)	Black	10,000 psi (689 bar)	ea.
U-1148	0.018" (0.45 mm)	12" (30 cm)	Black	10,000 psi (689 bar)	ea.

Stainless Steel Tubing (Cont.)

Part No.	ID	Length	Color	Maximum Pressure	Qty.
STAINLESS STEEL, 1/16" OD					
U-152	0.005" (0.125 mm)	2" (5 cm)	Red	21,600 psi (1,489 bar)	ea.
U-153	0.005" (0.125 mm)	4" (10 cm)	Red	21,600 psi (1,489 bar)	ea.
U-154	0.005" (0.125 mm)	8" (20 cm)	Red	21,600 psi (1,489 bar)	ea.
U-155	0.005" (0.125 mm)	12" (30 cm)	Red	21,600 psi (1,489 bar)	ea.
U-156	0.005" (0.125 mm)	1.6' (0.5 m)	Red	21,600 psi (1,489 bar)	ea.
U-157	0.005" (0.125 mm)	3.2' (1 m)	Red	21,600 psi (1,489 bar)	ea.
U-158	0.005" (0.125 mm)	5' (1.5 m)	Red	21,600 psi (1,489 bar)	ea.
U-160	0.005" (0.125 mm)	25' (7.6 m)	Red	21,600 psi (1,489 bar)	ea.
U-126	0.007" (0.175 mm)	2" (5 cm)	Black	20,900 psi (1,441 bar)	ea.
U-127	0.007" (0.175 mm)	4" (10 cm)	Black	20,900 psi (1,441 bar)	ea.
U-128	0.007" (0.175 mm)	8" (20 cm)	Black	20,900 psi (1,441 bar)	ea.
U-129	0.007" (0.175 mm)	12" (30 cm)	Black	20,900 psi (1,441 bar)	ea.
U-130	0.007" (0.175 mm)	1.6' (0.5 m)	Black	20,900 psi (1,441 bar)	ea.
U-131	0.007" (0.175 mm)	3.2' (1 m)	Black	20,900 psi (1,441 bar)	ea.
U-108	0.007" (0.175 mm)	5' (1.5 m)	Black	20,900 psi (1,441 bar)	ea.
U-161	0.007" (0.175 mm)	25' (7.6 m)	Black	20,900 psi (1,441 bar)	ea.
U-111	0.010" (0.25 mm)	2" (5 cm)	Blue	19,700 psi (1,358 bar)	ea.
U-112	0.010" (0.25 mm)	4" (10 cm)	Blue	19,700 psi (1,358 bar)	ea.
U-113	0.010" (0.25 mm)	8" (20 cm)	Blue	19,700 psi (1,358 bar)	ea.
U-114	0.010" (0.25 mm)	12" (30 cm)	Blue	19,700 psi (1,358 bar)	ea.
U-132	0.010" (0.25 mm)	1.6' (0.5 m)	Blue	19,700 psi (1,358 bar)	ea.
U-133	0.010" (0.25 mm)	3.2' (1 m)	Blue	19,700 psi (1,358 bar)	ea.
U-106	0.010" (0.25 mm)	5' (1.5 m)	Blue	19,700 psi (1,358 bar)	ea.
U-162	0.010" (0.25 mm)	25' (7.6 m)	Blue	19,700 psi (1,358 bar)	ea.
U-101	0.020" (0.5 mm)	2" (5 cm)	Yellow	15,800 psi (1,089 bar)	ea.
U-102	0.020" (0.5 mm)	4" (10 cm)	Yellow	15,800 psi (1,089 bar)	ea.
U-103	0.020" (0.5 mm)	8" (20 cm)	Yellow	15,800 psi (1,089 bar)	ea.
U-104	0.020" (0.5 mm)	12" (30 cm)	Yellow	15,800 psi (1,089 bar)	ea.
U-134	0.020" (0.5 mm)	1.6' (0.5 m)	Yellow	15,800 psi (1,089 bar)	ea.
U-135	0.020" (0.5 mm)	3.2' (1 m)	Yellow	15,800 psi (1,089 bar)	ea.
U-105	0.020" (0.5 mm)	5' (1.5 m)	Yellow	15,800 psi (1,089 bar)	ea.
U-163	0.020" (0.5 mm)	25' (7.6 m)	Yellow	15,800 psi (1,089 bar)	ea.
U-115	0.030" (0.75 mm)	2" (5 cm)	White	12,000 psi (827 bar)	ea.
U-116	0.030" (0.75 mm)	4" (10 cm)	White	12,000 psi (827 bar)	ea.
U-117	0.030" (0.75 mm)	8" (20 cm)	White	12,000 psi (827 bar)	ea.
U-118	0.030" (0.75 mm)	12" (30 cm)	White	12,000 psi (827 bar)	ea.
U-136	0.030" (0.75 mm)	1.6' (0.5 m)	White	12,000 psi (827 bar)	ea.
U-137	0.030" (0.75 mm)	3.2' (1 m)	White	12,000 psi (827 bar)	ea.
U-107	0.030" (0.75 mm)	5' (1.5 m)	White	12,000 psi (827 bar)	ea.
U-164	0.030" (0.75 mm)	25' (7.6 m)	White	12,000 psi (827 bar)	ea.
U-138	0.040" (1.0 mm)	2" (5 cm)	N/A	8,100 psi (558 bar)	ea.
U-139	0.040" (1.0 mm)	4" (10 cm)	N/A	8,100 psi (558 bar)	ea.
U-140	0.040" (1.0 mm)	8" (20 cm)	N/A	8,100 psi (558 bar)	ea.
U-141	0.040" (1.0 mm)	12" (30 cm)	N/A	8,100 psi (558 bar)	ea.
U-142	0.040" (1.0 mm)	1.6' (0.5 m)	N/A	8,100 psi (558 bar)	ea.
U-143	0.040" (1.0 mm)	3.2' (1 m)	N/A	8,100 psi (558 bar)	ea.
U-144	0.040" (1.0 mm)	5' (1.5 m)	N/A	8,100 psi (558 bar)	ea.
U-165	0.040" (1.0 mm)	25' (7.6 m)	N/A	8,100 psi (558 bar)	ea.
U-145	0.046" (1.15 mm)	2" (5 cm)	N/A	5,800 psi (400 bar)	ea.
U-146	0.046" (1.15 mm)	4" (10 cm)	N/A	5,800 psi (400 bar)	ea.
U-147	0.046" (1.15 mm)	8" (20 cm)	N/A	5,800 psi (400 bar)	ea.
U-148	0.046" (1.15 mm)	12" (30 cm)	N/A	5,800 psi (400 bar)	ea.
U-149	0.046" (1.15 mm)	1.6' (0.5 m)	N/A	5,800 psi (400 bar)	ea.
U-150	0.046" (1.15 mm)	3.2' (1 m)	N/A	5,800 psi (400 bar)	ea.
U-151	0.046" (1.15 mm)	5' (1.5 m)	N/A	5,800 psi (400 bar)	ea.
STAINLESS STEEL, 1/8" OD					
U-825	0.080" (2.0 mm)	10" (25 cm)	N/A	7,600 psi (524 bar)	ea.
U-800	0.080" (2.0 mm)	3.2' (1 m)	N/A	7,600 psi (524 bar)	ea.
U-803	0.080" (2.0 mm)	9.8' (3 m)	N/A	7,600 psi (524 bar)	ea.
U-805	0.080" (2.0 mm)	16' (5 m)	N/A	7,600 psi (524 bar)	ea.



PEEKsil™ Tubing

- › PEEK covered fused silica
- › 1/32" and 1/16" outside diameters with a wide variety of inside diameters
- › Precut to numerous standard lengths

PEEKsil's sheathing is mechanically strong and has ideal characteristics for sealing with many styles of fittings. The fused silica core provides a consistent and rigid fluid pathway with very tight tolerances and industry-accepted chemical properties. Together, this makes PEEKsil tubing ideal for numerous applications. In fact, PEEKsil can be used as a direct replacement for conventional stainless steel or PEEK tubing in many analytical systems.

Like traditional fused silica tubing, PEEKsil has excellent chemical compatibility and extremely low adsorption characteristics, especially when compared with stainless steel.

*Please Note: **Do not cut this tubing.** It should be used at its precut lengths because of permanent damage caused by conventional cutters.*

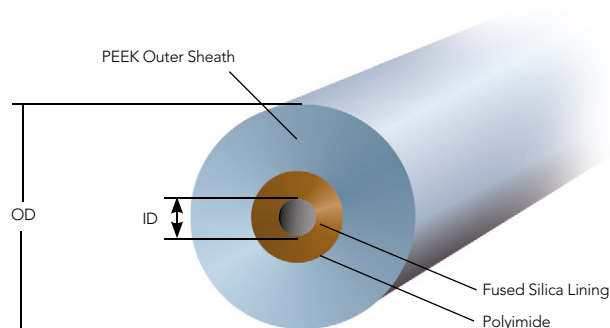

SPECIFICATIONS & DETAILS

Tubing OD	OD Tolerance	Tubing ID	ID Tolerance
		25 µm	±0.00004" (1 µm)
1/32"	±0.0008" (20 µm)	50–100 µm	±0.00012" (3 µm)
1/16"	±0.0012" (30 µm)	0.15–0.30 mm	±0.0002" (5 µm)



SPECIFICATIONS & DETAILS

Because PEEKsil tubing has fused silica tubing at its core, the pressure rating for this tubing is determined by the inner diameter of the tubing. The following chart highlights the Maximum Pressure values for this tubing, as determined by SGE International Pty., Ltd., the manufacturer of this tubing:

Tubing ID	Maximum Pressure
25 µm	25,000 psi (1,723 bar)
50 µm	20,000 psi (1,379 bar)
75–100 µm	15,000 psi (1,034 bar)
150–175 µm	8,500 psi (586 bar)
200–300 µm	6,000 psi (414 bar)

The pressure ratings provided are indicative of the performance capabilities of the tubing. The actual pressure limits achievable will depend upon the fittings used, the quality of the receiving port, and other factors. Contact IDEX Health & Science or your authorized Distributor for more information.

PEEKsil™ Tubing

4" (10 cm)	ID	Length	Color	Qty.
PEEKsil TUBING, 1/32" OD				
3255	0.001" (25 µm)	2" (5 cm)	Orange	2-pk
32510	0.001" (25 µm)	4" (10 cm)	Orange	2-pk
32515	0.001" (25 µm)	6" (15 cm)	Orange	2-pk
32520	0.001" (25 µm)	8" (20 cm)	Orange	2-pk
32550	0.001" (25 µm)	1.6' (50 cm)	Orange	2-pk
3505	0.002" (50 µm)	2" (5 cm)	Natural	2-pk
35010	0.002" (50 µm)	4" (10 cm)	Natural	2-pk
35015	0.002" (50 µm)	6" (15 cm)	Natural	2-pk
35020	0.002" (50 µm)	8" (20 cm)	Natural	2-pk
PEEKsil TUBING, 1/32" OD				
35050	0.002" (50 µm)	1.6' (50 cm)	Natural	2-pk
3755	0.003" (75 µm)	2" (5 cm)	Black	2-pk
37510	0.003" (75 µm)	4" (10 cm)	Black	2-pk
37515	0.003" (75 µm)	6" (15 cm)	Black	2-pk
37520	0.003" (75 µm)	8" (20 cm)	Black	2-pk
37550	0.003" (75 µm)	1.6' (50 cm)	Black	2-pk
31005	0.004" (100 µm)	2" (5 cm)	Red	2-pk
310010	0.004" (100 µm)	4" (10 cm)	Red	2-pk
310015	0.004" (100 µm)	6" (15 cm)	Red	2-pk
310020	0.004" (100 µm)	8" (20 cm)	Red	2-pk
310050	0.004" (100 µm)	1.6' (50 cm)	Red	2-pk
31505	0.006" (150 µm)	2" (5 cm)	Purple	2-pk
315010	0.006" (150 µm)	4" (10 cm)	Purple	2-pk
315015	0.006" (150 µm)	6" (15 cm)	Purple	2-pk
315020	0.006" (150 µm)	8" (20 cm)	Purple	2-pk
315050	0.006" (150 µm)	1.6' (50 cm)	Purple	2-pk
PEEKsil TUBING, 1/16" OD				
6255	0.001" (25 µm)	2" (5 cm)	Orange	5-pk
62510	0.001" (25 µm)	4" (10 cm)	Orange	5-pk
62515	0.001" (25 µm)	6" (15 cm)	Orange	5-pk
62520	0.001" (25 µm)	8" (20 cm)	Orange	5-pk
62550	0.001" (25 µm)	1.6' (50 cm)	Orange	2-pk
6505	0.002" (50 µm)	2" (5 cm)	Natural	5-pk
65010	0.002" (50 µm)	4" (10 cm)	Natural	5-pk
65015	0.002" (50 µm)	6" (15 cm)	Natural	5-pk
65020	0.002" (50 µm)	8" (20 cm)	Natural	5-pk
65050	0.002" (50 µm)	1.6' (50 cm)	Natural	2-pk
6755	0.003" (75 µm)	2" (5 cm)	Black	5-pk
67510	0.003" (75 µm)	4" (10 cm)	Black	5-pk
67515	0.003" (75 µm)	6" (15 cm)	Black	5-pk
67520	0.003" (75 µm)	8" (20 cm)	Black	5-pk
67550	0.003" (75 µm)	1.6' (50 cm)	Black	2-pk
61005	0.004" (100 µm)	2" (5 cm)	Red	5-pk
610010	0.004" (100 µm)	4" (10 cm)	Red	5-pk
610015	0.004" (100 µm)	6" (15 cm)	Red	5-pk
610020	0.004" (100 µm)	8" (20 cm)	Red	5-pk
610050	0.004" (100 µm)	1.6' (50 cm)	Red	2-pk
61505	0.006" (150 µm)	2" (5 cm)	Purple	5-pk
615010	0.006" (150 µm)	4" (10 cm)	Purple	5-pk
615015	0.006" (150 µm)	6" (15 cm)	Purple	5-pk
615020	0.006" (150 µm)	8" (20 cm)	Purple	5-pk
615050	0.006" (150 µm)	1.6' (50 cm)	Purple	2-pk
617515	0.007" (175 µm)	6" (15 cm)	Yellow	5-pk
617520	0.007" (175 µm)	8" (20 cm)	Yellow	5-pk
617550	0.007" (175 µm)	1.6' (50 cm)	Yellow	2-pk
62005	0.008" (200 µm)	2" (5 cm)	Blue	5-pk
620015	0.008" (200 µm)	6" (15 cm)	Blue	5-pk
620020	0.008" (200 µm)	8" (20 cm)	Blue	5-pk
620050	0.008" (200 µm)	1.6' (50 cm)	Blue	2-pk
63005	0.012" (300 µm)	2" (5 cm)	Gray	5-pk
630010	0.012" (300 µm)	4" (10 cm)	Gray	5-pk
630015	0.012" (300 µm)	6" (15 cm)	Gray	5-pk
630020	0.012" (300 µm)	8" (20 cm)	Gray	5-pk
630050	0.012" (300 µm)	1.6' (50 cm)	Gray	2-pk

PFA Tubing

PFA Tubing

- › 1/16" and 1/8" ODs available
- › Excellent solvent resistance and low gas permeability
- › Constructed with genuine Teflon™ PFA resin

PFA (perfluoroalkoxyalkane) tubing offers excellent solvent resistance (virtually identical to FEP and PTFE) while adding several advantages. These include smoother surface texture, higher continuous service temperature and superior polymer purity. The recommended maximum operating temperature for our PFA tubing is 80 °C.

High Purity PFA Tubing

- › 360 µm, 1/16", 1/8", 3/16", and 1/4" outside diameters available
- › PFA HP and PFA HP Plus Grades available
- › Virtually contaminant free
- › Constructed with genuine Teflon™ High Purity PFA resin

PFA High Purity (HP) tubing offers all of the benefits of standard PFA tubing, with the additional benefit of being manufactured from a premium grade of PFA that is one of the most contaminant-free polymers available. In PFA HP, we offer tubing with the following outer diameters: 1/16", 1/8", 3/16", and 1/4".

PFA High Purity (HP) Plus tubing carries all of the benefits of PFA HP tubing, with the additional benefits of increased ability to withstand repeated flexing; improved resistance to stress cracking when exposed to aggressive fluorosurfactants; and smoother, clearer walls. In PFA HP Plus, we offer tubing with the following outer diameters: 360 µm, 1/16", and 1/8".

(Please Note: Due to the physical nature of the 360 µm OD tubing, we recommend using our A-350 Polymer Tubing Cutter from page 28 when cutting this tubing to length. Additionally, extra care should be taken to ensure fittings are not overtightened and to ensure the tubing is not stretched once secured in place, to ensure the dimensional stability of the tubing.)



SPECIFICATIONS & DETAILS

Tubing OD	OD Tolerances	Tubing ID	ID Tolerance
PFA TUBING SPECIFICATIONS			
1/16"	±0.001" (25 µm)	All	±0.001" (25 µm)
1/8"	±0.003" (75 µm)	All	±0.003" (75 µm)
HIGH PURITY PFA TUBING SPECIFICATIONS			
1/16"	±0.001" (25 µm)	All	±0.001" (25 µm)
1/8"	±0.003" (75 µm)	All	±0.003" (75 µm)
3/16"	±0.003" (75 µm)	All	±0.003" (75 µm)
1/4"	±0.004" (100 µm)	All	±0.004" (100 µm)
360 µM OD PFA HP TUBING SPECIFICATIONS			
360 µm	±0.0005" (12.5 µm)	All	±0.0005" (12.5 µm)

PFA Tubing

Part No.	ID	Length	Color	Max. Pressure	Qty.
PFA TUBING, 1/16" OD					
1500	0.020" (0.50 mm)	5' (1.5 m)	Natural	2,000 psi (138 bar)	ea.
1512L	0.020" (0.50 mm)	50' (15 m)	Natural	2,000 psi (138 bar)	ea.
1512M	0.020" (0.50 mm)	1,000' (304 m)	Natural	2,000 psi (138 bar)	ea.
1502	0.030" (0.75 mm)	5' (1.5 m)	Natural	1,000 psi (69 bar)	ea.
1514L	0.030" (0.75 mm)	50' (15 m)	Natural	1,000 psi (69 bar)	ea.
1514M	0.030" (0.75 mm)	1,000' (304 m)	Natural	1,000 psi (69 bar)	ea.
1503	0.040" (1.0 mm)	5' (1.5 m)	Natural	500 psi (34 bar)	ea.
1507L	0.040" (1.0 mm)	50' (15 m)	Natural	500 psi (34 bar)	ea.
1507M	0.040" (1.0 mm)	1,000' (304 m)	Natural	500 psi (34 bar)	ea.
PFA TUBING, 1/8" OD					
1509-5	0.062" (1.55 mm)	5' (1.5 m)	Natural	500 psi (34 bar)	ea.
1509L	0.062" (1.55 mm)	50' (15 m)	Natural	500 psi (34 bar)	ea.
PFA HP TUBING, 1/16" OD					
1622-5	0.020" (0.50 mm)	5' (1.5 m)	Natural	2,000 psi (138 bar)	ea.
1622L	0.020" (0.50 mm)	50' (15 m)	Natural	2,000 psi (138 bar)	ea.
1622M	0.020" (0.50 mm)	1,000' (304 m)	Natural	2,000 psi (138 bar)	ea.
1632-5	0.030" (0.75 mm)	5' (1.5 m)	Natural	1,000 psi (69 bar)	ea.
1632L	0.030" (0.75 mm)	50' (15 m)	Natural	1,000 psi (69 bar)	ea.
1632M	0.030" (0.75 mm)	1,000' (304 m)	Natural	1,000 psi (69 bar)	ea.
PFA HP TUBING, 1/8" OD					
1641-5	0.062" (1.55 mm)	5' (1.5 m)	Natural	500 psi (34 bar)	ea.
1641L	0.062" (1.55 mm)	50' (15 m)	Natural	500 psi (34 bar)	ea.
PFA HP PLUS TUBING, 1/16" OD					
1902-5	0.010 (0.25 mm)	5' (1.5 m)	Natural	3,000 psi (207 bar)	ea.
1902L	0.010 (0.25 mm)	50' (15 m)	Natural	3,000 psi (207 bar)	ea.
1902M	0.010 (0.25 mm)	1,000' (304 m)	Natural	3,000 psi (207 bar)	ea.
1907-5	0.020" (0.50 mm)	5' (1.5 m)	Natural	2,000 psi (138 bar)	ea.
1907L	0.020" (0.50 mm)	50' (15 m)	Natural	2,000 psi (138 bar)	ea.
1907M	0.020" (0.50 mm)	1,000' (304 m)	Natural	2,000 psi (138 bar)	ea.
1912-5	0.030" (0.75 mm)	5' (1.5 m)	Natural	1,000 psi (69 bar)	ea.
1912L	0.030" (0.75 mm)	50' (15 m)	Natural	1,000 psi (69 bar)	ea.
1912M	0.030" (0.75 mm)	1,000' (304 m)	Natural	1,000 psi (69 bar)	ea.
PFA HP PLUS TUBING, 1/8" OD					
1921-5	0.062" (1.55 mm)	5' (1.5 m)	Natural	500 psi (34 bar)	ea.
1921L	0.062" (1.55 mm)	50' (15 m)	Natural	500 psi (34 bar)	ea.



FEP Tubing

- › Great for moderate-to-low pressure applications
- › 1/16", 1/8", 3/16", 1/4", or 5/16" outside diameter available
- › 1 mm, 2 mm, or 3 mm outside diameter available
- › Maximum continuous use temperature: 50 °C
- › Constructed with genuine Teflon™ FEP resin

With virtually identical chemical resistance to PFA at a lower price, FEP tubing is great for general, low pressure applications. Compared to PTFE, FEP (fluorinated ethylene propylene) tubing is held to tighter tolerances and has lower gas permeability (see material properties on our website: www.idex-hs.com).

Much of our FEP Tubing — even the color-tinted options — is translucent, making it possible to watch fluid flow. Using different colored tubing can help identify transfer lines in multisolvent systems. Color coding also allows easy identification of the tubing thru-hole size. Black FEP tubing is available for light-sensitive applications (such as enzymatic and chemi-luminescent reactions) and entering/exiting flow cells.



SPECIFICATIONS & DETAILS

Tubing Size	OD Tolerances	ID Tolerances
1/16" OD	±0.001" (25 µm)	±0.001" (25 µm)
1/8" OD	±0.003" (75 µm)	±0.003" (75 µm)
3/16" OD	±0.004" (0.10 mm)	±0.004" (0.10 mm)
5/16" OD	±0.004" (0.10 mm)	±0.004" (0.10 mm)
1 mm OD	±0.001" (25 µm)	±0.001" (25 µm)
2 mm OD	±0.003" (75 µm)	±0.003" (75 µm)
3 mm OD	±0.003" (75 µm)	±0.003" (75 µm)

Part No.	ID	Length	Color	Max. Pressure	Qty.
FEP TUBING, 1/16" OD					
1527-5	0.010" (0.25 mm)	5' (1.5 m)	Natural	3,000 psi (207 bar)	ea.
1527L	0.010" (0.25 mm)	50' (15 m)	Natural	3,000 psi (207 bar)	ea.
1527XL	0.010" (0.25 mm)	100' (30 m)	Natural	3,000 psi (207 bar)	ea.
1527M	0.010" (0.25 mm)	1,000' (304 m)	Natural	3,000 psi (207 bar)	ea.
1548-5	0.020" (0.50 mm)	5' (1.5 m)	Natural	2,000 psi (138 bar)	ea.
1548L	0.020" (0.50 mm)	50' (15 m)	Natural	2,000 psi (138 bar)	ea.
1548XL	0.020" (0.50 mm)	100' (30 m)	Natural	2,000 psi (138 bar)	ea.
1548M	0.020" (0.50 mm)	1,000' (304 m)	Natural	2,000 psi (138 bar)	ea.
1520-5	0.030" (0.75 mm)	5' (1.5 m)	Natural	1,000 psi (69 bar)	ea.
1520L	0.030" (0.75 mm)	50' (15 m)	Natural	1,000 psi (69 bar)	ea.
1520XL	0.030" (0.75 mm)	100' (30 m)	Natural	1,000 psi (69 bar)	ea.
1520M	0.030" (0.75 mm)	1,000' (304 m)	Natural	1,000 psi (69 bar)	ea.
FEP TUBING, 1/8" OD					
1521-5	0.062" (1.55 mm)	5' (1.5 m)	Natural	500 psi (34 bar)	ea.
1521L	0.062" (1.55 mm)	50' (15 m)	Natural	500 psi (34 bar)	ea.
1521XL	0.062" (1.55 mm)	100' (30 m)	Natural	500 psi (34 bar)	ea.
FEP TUBING, 3/16" OD					
1524L	0.125" (3.2 mm)	50' (15 m)	Natural	500 psi (34 bar)	ea.
1524XL	0.125" (3.2 mm)	100' (30 m)	Natural	500 psi (34 bar)	ea.
FEP TUBING, 1/4" OD					
1650L	0.188" (4.8 mm)	50' (15 m)	Natural	250 psi (17 bar)	ea.
1650XL	0.188" (4.8 mm)	100' (30 m)	Natural	250 psi (17 bar)	ea.
FEP TUBING, 1.0 MM OD					
1671L	0.020" (0.50 mm)	50' (15 m)	Natural	500 psi (34 bar)	ea.
1671XL	0.020" (0.50 mm)	100' (30 m)	Natural	500 psi (34 bar)	ea.
FEP TUBING, 2.0 MM OD					
1673L	0.40" (1.0 mm)	50' (15 m)	Natural	500 psi (34 bar)	ea.
1673XL	0.40" (1.0 mm)	100' (30 m)	Natural	500 psi (34 bar)	ea.
FEP TUBING, 3.0 MM OD					
1677L	0.080" (2.0 mm)	50' (15 m)	Natural	500 psi (34 bar)	ea.
1677XL	0.080" (2.0 mm)	100' (30 m)	Natural	500 psi (34 bar)	ea.

ETFE Tubing

- › Excellent chemical resistance
- › Constructed with genuine Tefzel™ resin
- › Holds pressure up to 4,000 psi (276 bar)
- › 1/16" or 1/8" outside diameter available
- › Maximum continuous operating temperature: 80 °C

ETFE (ethylene-tetrafluoroethylene) tubing is an excellent fluoropolymer product that offers several benefits over tubing manufactured from PTFE, FEP, or PFA. These benefits include enhanced pressure holding capabilities, increased mechanical stability and lower gas permeability.



APPLICATION NOTE

ETFE tubing is an ideal choice for the fluid pathway between the vacuum degasser and the system's pump. Its low gas permeability will help ensure the mobile phase solvents do not regas while in transit.



RELATED PRODUCTS

Other tubing materials and dimensions may be available. Please contact IDEX Health & Science or your local representative directly.



SPECIFICATIONS & DETAILS

Tubing OD	Tubing ID	OD/ID Tolerances
1/16" OD	0.010" (0.25 mm), 0.020" (0.50 mm), 0.030" (0.75 mm)	±0.001" (25 µm)
1/16" OD	0.040" (1.0 mm)	±0.002" (50 µm)
1/8" OD	All	±0.003" (75 µm)

Part No.	ID	Length	Color	Max. Pressure	Qty.
ETFE TUBING, 1/16" OD					
1529	0.010 (0.25 mm)	5' (1.5 m)	Natural	4,000 psi (276 bar)	ea.
1529L	0.010 (0.25 mm)	50' (15 m)	Natural	4,000 psi (276 bar)	ea.
1529XL	0.010 (0.25 mm)	100' (30 m)	Natural	4,000 psi (276 bar)	ea.
1529M	0.010 (0.25 mm)	1,000' (304 m)	Natural	4,000 psi (276 bar)	ea.
1516	0.020" (0.50 mm)	5' (1.5 m)	Natural	3,000 psi (207 bar)	ea.
1516L	0.020" (0.50 mm)	50' (15 m)	Natural	3,000 psi (207 bar)	ea.
1516XL	0.020" (0.50 mm)	100' (30 m)	Natural	3,000 psi (207 bar)	ea.
1516M	0.020" (0.50 mm)	1,000' (304 m)	Natural	3,000 psi (207 bar)	ea.
1528	0.030" (0.75 mm)	5' (1.5 m)	Natural	2,000 psi (138 bar)	ea.
1528L	0.030" (0.75 mm)	50' (15 m)	Natural	2,000 psi (138 bar)	ea.
1528XL	0.030" (0.75 mm)	100' (30 m)	Natural	2,000 psi (138 bar)	ea.
1528M	0.030" (0.75 mm)	1,000' (304 m)	Natural	2,000 psi (138 bar)	ea.
1517	0.040" (1.0 mm)	5' (1.5 m)	Natural	500 psi (34 bar)	ea.
1517L	0.040" (1.0 mm)	50' (15 m)	Natural	500 psi (34 bar)	ea.
1517XL	0.040" (1.0 mm)	100' (30 m)	Natural	500 psi (34 bar)	ea.
1517M	0.040" (1.0 mm)	1,000' (304 m)	Natural	500 psi (34 bar)	ea.
ETFE TUBING, 1/8" OD					
1530	0.062" (1.55 mm)	5' (1.5 m)	Natural	1,000 psi (69 bar)	ea.
1530L	0.062" (1.55 mm)	50' (15 m)	Natural	1,000 psi (69 bar)	ea.
1530XL	0.062" (1.55 mm)	100' (30 m)	Natural	1,000 psi (69 bar)	ea.
1648	0.093" (2.4 mm)	5' (1.5 m)	Natural	500 psi (34 bar)	ea.
1648L	0.093" (2.4 mm)	50' (15 m)	Natural	500 psi (34 bar)	ea.
1648XL	0.093" (2.4 mm)	100' (30 m)	Natural	500 psi (34 bar)	ea.



Tools

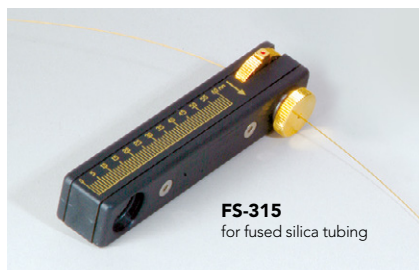

FS-315
for fused silica tubing

Fused Silica Tubing Cutters

We offer a precision cutter for fused silica tubing — SGT's Shortix™ Cutter (FS-315). This cutter ensures clean, trouble-free cutting of fused silica tubing, providing better cuts than any other product on the market. It also includes a built-in magnifying glass to examine the cut tubing ends. Order the FS-315-02 Maintenance Kit, as needed, to replace a worn or damaged cutting wheel.

When using traditional fused silica tubing cutters, only a small part of the tubing wall is scratched, then the tubing is snapped or pulled in two, often resulting in a jagged, uneven cut. With a Shortix Cutter, a clean cut is made every time, regardless of skill or experience, as the cut is made by rotating a diamond blade around the entire circumference of the tubing.

Please Note: The FS-315 Fused Silica Tubing Cutters are designed to cut only tubing with ODs of 350 μ m–780 μ m and IDs of 100 μ m–350 μ m.

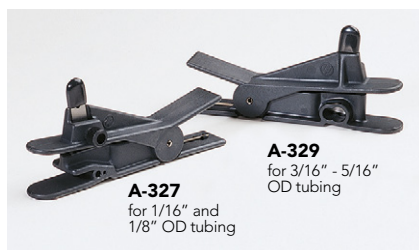

A-327
for 1/16" and 1/8" OD tubing

A-329
for 3/16" - 5/16" OD tubing

Polymer Tubing Cutters

› For 1/16", 1/8", 3/16", 1/4", and 5/16" OD tubing

A flat, 90°, burr-free cut is difficult to obtain with most commercial polymer tubing cutters. Our experts have designed several tubing cutters specifically to cut polymer tubing. This line of tubing cutters includes a standard cutter for 1/16" and 1/8" OD tubing (A-327), and another for large bore tubing (A-329). Each has guide holes to ensure precise cutting. These cutters are durable, reliable, and easy to operate. Five replacement blades are included with each tool.



A-350
for capillary polymer tubing

Capillary Polymer Tubing Cutters

Our A-350 Cutter is designed to cut capillary-sized polymer tubing. The cutter makes clean, perpendicular cuts without collapsing thin capillary walls. A set of ten tubing sleeves, required for cutting, are included with each cutter, along with five replacement blades. The included tubing sleeves are for cutting 360 μ m OD polymer capillary tubing. Alternative sleeves are available for cutting 1/32" OD tubing. All tubing sleeves are 2" long and constructed with genuine Teflon™ FEP resin.

NOTE

- › The A-350 Capillary Polymer Tubing Cutter can be used to cut tubing OD sizes other than 360 μ m and 1/32". Simply use the proper NanoTight™ Tubing Sleeve found on page 52. Please note, however, that these sleeves are shorter than those listed on this page, and therefore will last through fewer cuts.
- › Our tubing cutters are material specific: the A-327, A-329, and A-350 should only be used to cut polymer tubing, where as the FS-315 should only be used to cut fused silica tubing.

Part No.	Description	Qty.
FUSED SILICA TUBING CUTTERS		
FS-315	Shortix Fused Silica Tubing Cutter	ea.
CAPILLARY POLYMER TUBING CUTTER		
A-350	Capillary Polymer Tubing Cutter* for 360 μ m–1/32" OD tubing Includes (1) F-262x 10-pack of sleeves and (1) M-438-03 wrench	ea.
F-262x	Replacement Sleeves for A-350, 0.0155" ID, Green, for cutting 360 μ m OD tubing	10-pk
A-327	Standard Polymer Tubing Cutter* for 1/16" and 1/8" OD tubing	ea.
A-329	Large Bore Polymer Tubing Cutter* for 3/16"– 5/16" OD tubing	ea.
A-328	Replacement Blades for A-350, A-327, and A-329	5-pk

* Includes (1) A-328 5-pack of replacement blades.

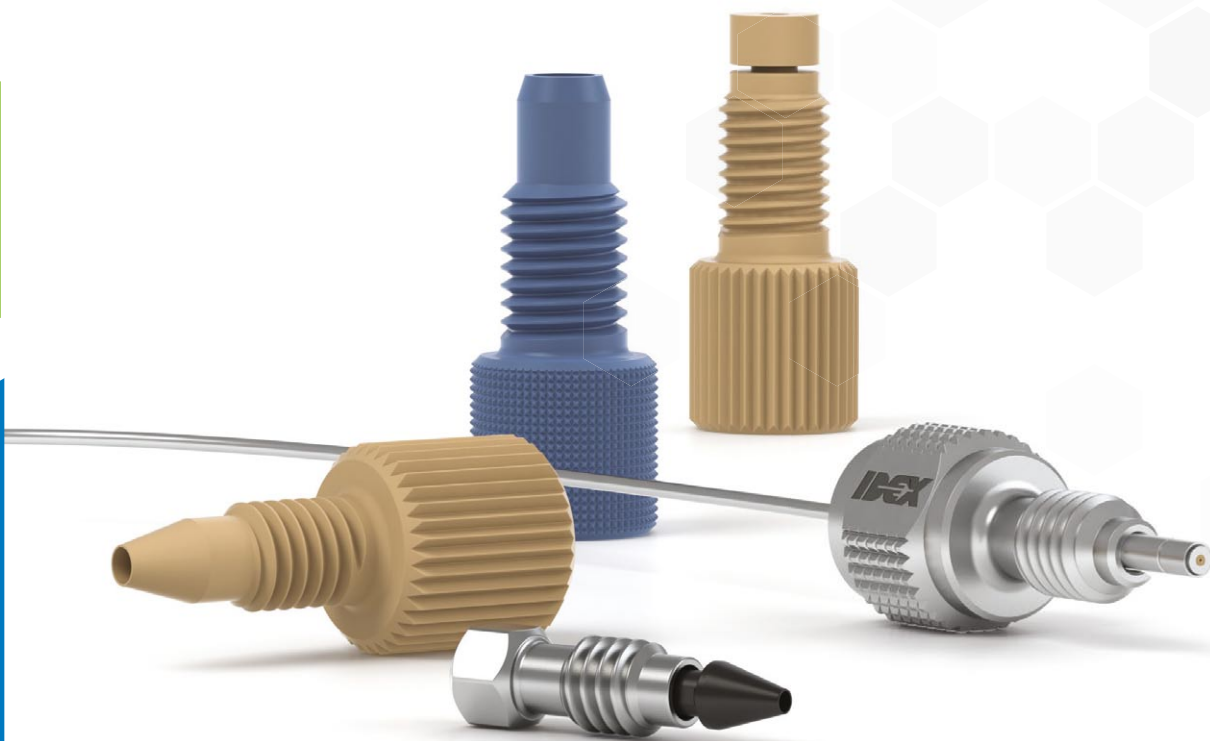

FITTINGS

We offer a wide and diverse selection of fittings to meet your system requirements. A “fitting” refers to a complete product ready to assemble and connect tubing into a part. This could be a one-piece connector or a nut and ferrule packaged together. A “Nut” indicates the male or female threaded product sold separately, and a “Ferrule” is sold separately when indicated in the description. For your convenience we ship most Fittings and Ferrules in 10-packs. We are dedicated to providing the most reliable, proven products on the market. We have implemented more stringent testing protocols and a generous safety margin to our ratings to ensure your safety.

32 CONED FITTINGS

39 FLAT-BOTTOM FITTINGS

48 MARVELX™

50 FITTINGS TOOLS

56 LARGE BORE FITTINGS

57 VHP FITTINGS

61 FITTINGS KITS



NOTE

All testing is performed with water at room temperature unless otherwise specified. Please contact IDEX Health & Science directly for further details. Results may vary depending on the material of the receiving port and tubing, actual tubing diameters (with stated tolerances), temperature and solvents used. If a pressure range is listed for a product's specification, the pressure rating depends on the tubing material used. The lower end of the range will represent testing performed on softer tubing such as FEP, and the higher end of the range will represent testing performed on harder tubing such as Stainless Steel. For more detail, please see the product specification sheets on our website, www.idex-hs.com, or contact us directly.



APPLICATION NOTE

What Threads Do I Have?

Hold your fitting over the thread silhouettes below to identify the threads.

U.S. CUSTOMARY THREADS

6-40



6-32



10-32



1/4-28



5/16-24



1/2-20



METRIC THREADS

M4 x 0.7



M6 x 1





One-Piece Fingertight Fittings

- › The original One-Piece Fingertight Fitting
- › All polymer construction
- › Versions available for 1/16", 1/32" or 1/8" OD tubing
- › Convenient and easy to use
- › Reusable

NOTE

- › Some of the fittings on this page are available in additional colors. Please contact your distributor or us for more information.
- › Fingertight is generally equal to 3–4 in-lbs (0.34–0.45 N·m).

Our One-Piece Fingertight Fittings provide convenience and ease of use because the ferrule will not stick in a receiving port and the fitting is more easily found if dropped. The fittings for 1/16" OD tubing and 10-32 coned ports are available in a variety of colors, materials and lengths to suit virtually every application.

Beyond the standard 10-32 fittings, also featured in this product family are specialty fittings for specific applications. Our M-645 Fitting is a direct replacement for the 6-40 threaded VICI® (Valco) fitting. The P-100 can be used in 1/4-28 coned ports for 1/8" OD tubing including some of the inlet filters starting on page 102.

RheFlex® One-Piece Fittings are included in many of the manual valves, starting on page 121. The One-Piece RheFlex M4 Fittings, for use with our MX Nano-Scale Modules, are listed on page 61.

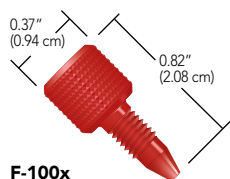

F-100x
10-32 PCTFE Fitting

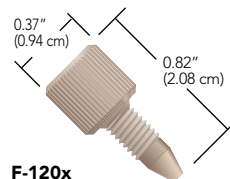

F-120x
10-32 PEEK Fitting

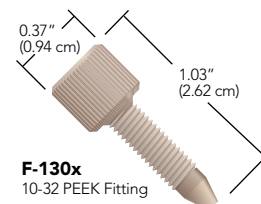

F-130x
10-32 PEEK Fitting

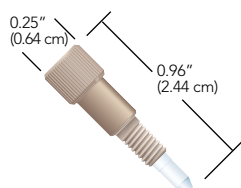

M-645x
6-40 PEEK/PCTFE Fitting
for 1/32" OD tubing

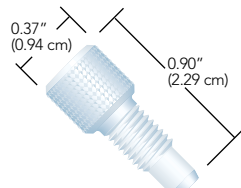

P-100
1/4-28 PCTFE Fitting
for 1/8" OD tubing

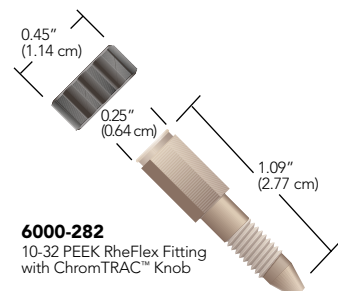

6000-282
10-32 PEEK RheFlex Fitting
with ChromTRAC™ Knob

Part No.	Description	Port	Pressure Rating	Head Style	Material	Qty.
ONE-PIECE FINGERTIGHT FITTINGS						
6000-282	Fingertight Fitting for 1/16" OD Tubing	10-32 Coned	5,000 psi (345 bar)	ChromTRAC knob	PEEK, Natural	10-pk
F-100x	Fingertight Fitting for 1/16" OD Tubing	10-32 Coned	4,000 psi (276 bar)	Diamond Knurl	PCTFE, Red	10-pk
F-120x	Fingertight Fitting for 1/16" OD Tubing	10-32 Coned	5,000 psi (345 bar)	Standard Knurl	PEEK, Natural	10-pk
F-130x	Fingertight Fitting for 1/16" OD Tubing, Long	10-32 Coned	5,000 psi (345 bar)	Standard Knurl	PEEK, Natural	10-pk
M-645x	Fingertight Fitting for 1/32" OD Tubing	6-40 Coned	1,750–3,250 psi (121–224 bar)	Headless Knurl	PEEK, Natural/PCTFE, Natural	10-pk
P-100	Fingertight Fitting for 1/8" OD Tubing	1/4-28 Coned	1,000 psi (69 bar)	Diamond Knurl	PCTFE, Natural	ea.



Stainless Steel Fittings

NOTE

- Do not use metal fittings in plastic ports, as this can damage the port.
- The recommended torque to tighten these fittings is 20 in-lbs (2.25 N·m).

These 316 Stainless Steel Fittings are rated to 20,000 psi (1,380 bar) when wrench tightened. Choose IDEX Health & Science standard fittings, or select from the Common Valve Fittings or other manufacturer-compatible offerings.

Standard Stainless Steel Fittings

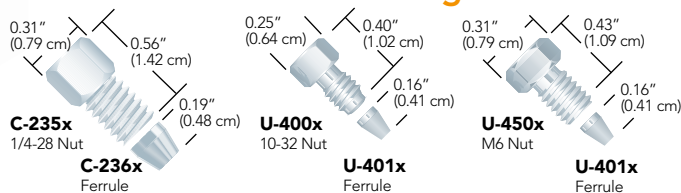

Common Valve Fittings

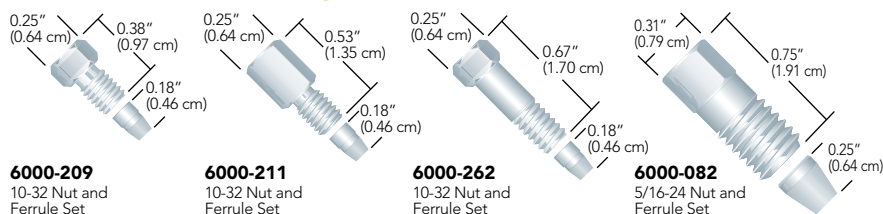

Beckman® Compatible Fittings

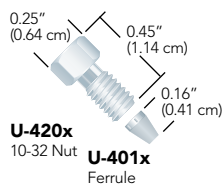

VICI® (Valco) Compatible Fittings

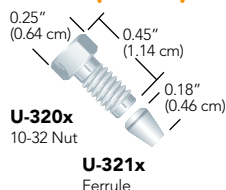

Part No.	Description	Port	Pressure Rating	Head Style	Material	Qty.
STANDARD STAINLESS STEEL FITTINGS						
C-235x	Nut for 1/8" OD Tubing	1/4-28 Coned	20,000 psi (1,380 bar)	5/16" Hex	SST	10-pk
C-236x	Ferrule for 1/8" OD Tubing	1/4-28 Coned	20,000 psi (1,380 bar)	—	SST	10-pk
U-400x	Nut for 1/16" OD Tubing	10-32 Coned	20,000 psi (1,380 bar)	1/4" Hex	SST	10-pk
U-401x	Ferrule for 1/16" OD Tubing	10-32 or M6 Coned	20,000 psi (1,380 bar)	—	SST	10-pk
U-450x	Nut for 1/16" OD Tubing	M6 Coned	20,000 psi (1,380 bar)	5/16" Hex	SST	10-pk
COMMON VALVE FITTINGS						
6000-082	Fitting for 1/8" OD Tubing	5/16-24 Coned	20,000 psi (1,380 bar)	5/16" Hex	SST	ea.
6000-083	Ferrule for 1/8" OD Tubing	5/16-24 Coned	20,000 psi (1,380 bar)	—	SST	5-pk
6000-209	Fitting for 1/16" OD Tubing	10-32 Coned	20,000 psi (1,380 bar)	1/4" Hex	SST	10-pk
6000-210	Ferrule for 1/16" OD Tubing	10-32 Coned	20,000 psi (1,380 bar)	—	SST	10-pk
6000-211	Fitting for 1/16" OD Tubing, Long	10-32 Coned	20,000 psi (1,380 bar)	1/4" Hex	SST	10-pk
6000-262	Fitting for 1/16" OD Tubing, Extra Long	10-32 Coned	20,000 psi (1,380 bar)	1/4" Hex	SST	10-pk
MANUFACTURER COMPATIBLE FITTINGS						
U-320x	Nuts for 1/16" OD Tubing, Valco/VICI Compatible	10-32 Coned	20,000 psi (1,380 bar)	1/4" Hex	SST	10-pk
U-321x	Ferrule for 1/16" OD Tubing, Valco/VICI Compatible	10-32 Coned	20,000 psi (1,380 bar)	—	SST	10-pk
U-410x	Nuts for 1/16" OD Tubing, Waters Compatible	10-32 Coned	20,000 psi (1,380 bar)	5/16" Hex	SST	10-pk



MicroTight® Fittings

- › Comprehensive Fitting System for Connecting Capillary Tubing
- › Made from PEEK Polymer

MicroTight® One-Piece Fittings are designed for use with the NanoPort™ and MicroTight Unions, Adapters and Inline MicroFilters. Specifically made for 360 µm OD tubing, 1/32" OD tubing, or our MicroTight Tubing Sleeves (see page 52), these fittings make superior fingertight connections with capillary tubing. MicroTight Fittings withstand temperatures up to 125 °C.

The MicroTight family also includes a female nut matched with one of five dedicated ferrules for connecting specific tubing ODs.

Use the P-277 Extender Tool to tighten standard micro knurl 6-32 fittings in hard-to-reach places. Tighten micro headless 6-32 fittings with our N-290 Tool. See page 50 for more information.



NOTE

MicroTight fittings and MicroFerrules

While the MicroTight Female Nuts may be used with any of the separate MicroFerrules, the MicroFerrules themselves are port-specific and are thus not interchangeable. Additionally, the one-piece MicroTight fittings are also port-specific and should not be exchanged.



F-1245x
Standard Head Fitting
for use with
360 µm OD tubing

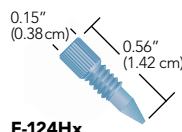

F-124Hx
Headless Fitting
for use with
360 µm OD tubing

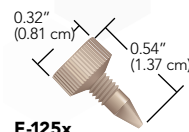

F-125x
Standard Head Fitting
for use with
MicroTight Sleeves



F-125Hx
Headless Fitting
for use with
MicroTight Sleeves

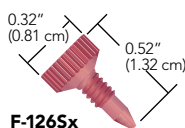

F-1265x
Standard Head Fitting for
use with 1/32" OD tubing

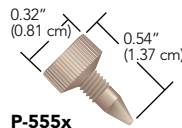

P-555x
Standard Head Plug

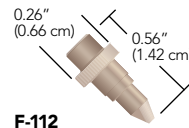

F-112
MicroFerrule for
1/32" OD tubing



F-132
MicroFerrule for
1/16" OD tubing

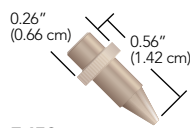

F-152
MicroFerrule for
360 µm OD tubing

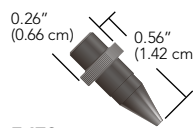

F-172
MicroFerrule for
0.025" OD tubing

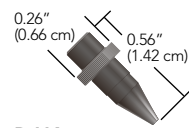

P-116
MicroFerrule Plug

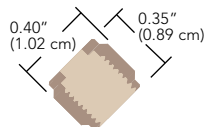

P-416
Female Nut
5/16-24 internal threads



P-416BLK
Female Nut
5/16-24 internal threads



P-416G
Female Nut
5/16-24 internal threads



RELATED PRODUCTS

- › Connectors for Capillary Tubing can be found on page 75.
- › Very High Pressure fittings for capillary tubing can be found on page 58.
- › Capillary tubing is featured on page 16.

Part No.	Description	Port	Pressure Rating	Head Style	Material	Qty.
MICROTIGHT FITTINGS						
F-124Hx	MicroTight Fitting for 360 µm OD Tubing	6-32 Coned	5,000 psi (345 bar)	Micro Headless Knurl	PEEK Blue	10-pk
F-1245x	MicroTight Fitting for 360 µm OD Tubing	6-32 Coned	5,000 psi (345 bar)	Standard Micro Knurl	PEEK Blue	10-pk
F-125Hx	MicroTight Fitting for MicroTight Tubing Sleeves	6-32 Coned	4,000 psi (276 bar)	Micro Headless Knurl	PEEK Natural	10-pk
F-125x	MicroTight Fitting for MicroTight Tubing Sleeves	6-32 Coned	4,000 psi (276 bar)	Standard Micro Knurl	PEEK Natural	10-pk
F-1265x	MicroTight Fitting for 1/32" OD Tubing	6-32 Coned	5,000 psi (345 bar)	Standard Micro Knurl	PEEK Red	10-pk
P-555x	MicroTight Plug	6-32 Coned	5,000 psi (345 bar)	Standard Micro Knurl	PEEK Natural	10-pk
MICROFERRULES AND FEMALE NUTS						
F-112	MicroFerrule for 1/32" OD Tubing	5/16-24 Coned	5,000 psi (345 bar)	—	PEEK Natural	ea.
F-132	MicroFerrule for 1/16" OD Tubing	5/16-24 Coned	5,000 psi (345 bar)	—	PEEK Natural	ea.
F-152	MicroFerrule for 360 µm OD Tubing	5/16-24 Coned	5,000 psi (345 bar)	—	PEEK Natural	ea.
F-152BLK	MicroFerrule for 360 µm OD Tubing	5/16-24 Coned	5,000 psi (345 bar)	—	PEEK Black	ea.
F-172	MicroFerrule for MicroTight Tubing Sleeves	5/16-24 Coned	4,000 psi (276 bar)	—	PEEK Black	ea.
P-116	MicroFerrule Plug	5/16-24 Coned	5,000 psi (345 bar)	—	PEEK Black	ea.
P-416	MicroTight Female Nut	5/16-24 Coned	4,000–5,000 psi (276–345 bar)	Female Knurl	PEEK Natural	ea.
P-416BLK	MicroTight Female Nut	5/16-24 Coned	4,000–5,000 psi (276–345 bar)	Female Knurl	PEEK Black	ea.
P-416G	MicroTight Female Nut	5/16-24 Coned	4,000–5,000 psi (276–345 bar)	Female Knurl	PEEK Green	ea.



Two-Piece Fingertight Fittings

- › Designed to connect tubing to 10-32 coned ports
- › Ferrules available for directly connecting 1/16", 1/32", 360 µm, or 190 µm OD tubing
- › Economical, replace only the ferrule



APPLICATION NOTE

Some Fingertight Nuts feature wings in addition to a knurled head, which provide more leverage when tightening the fitting into a receiving port. Choose our single or double-winged design.

Please Note: customers can use the standard knurl head fittings with our tightening tools found on page 50.

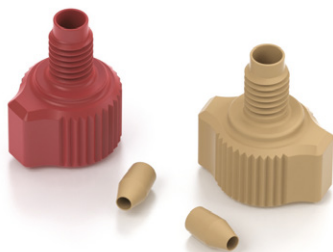

Two-Piece Fingertight Fittings feature a separate ferrule. Use a standard knurled head fitting for traditional fingertight applications, or use a fitting with wings built into the head for extra tightening leverage. A stainless steel hex headed fitting can be used for applications where a wrench may be needed for added tightening torque.

The M-215 Conductive Perfluoroelastomer Ferrule is designed for mass spectrometer electrospray applications. Unlike most graphite ferrules, the elastomeric properties of this ferrule let you use it through many tightening/retightening cycles. It also eliminates any possibility of graphite contamination in your system. Like graphite ferrules, you can apply voltage through a metallic port block or metallic nut, allowing voltage to translate to the flow path through the ferrule.

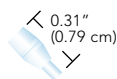

F-148
PCTFE Ferrule
for 190 µm OD tubing

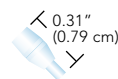

F-151
PCTFE Ferrule
for 360 µm OD tubing

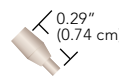

F-113
PEEK Ferrule
for 1/32" OD tubing

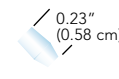

F-142N
ETFE Ferrule
for 1/16" OD tubing



M-215
Conductive
Perfluoroelastomer
Ferrule for 360 µm
OD tubing

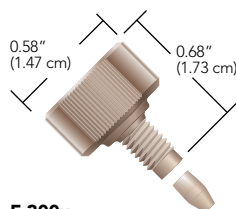

F-300x
10-32 PEEK Double-Winged Nut
with F-142x PEEK Ferrule

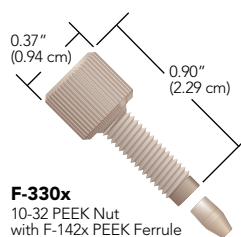

F-330x
10-32 PEEK Nut
with F-142x PEEK Ferrule

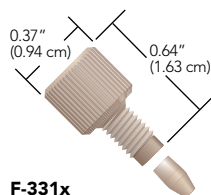

F-331x
10-32 PEEK Nut
with F-142x PEEK Ferrule

Part No.	Description	Port	Pressure Rating	Head Style	Material	Qty.
TWO-PIECE FINGERTIGHT FITTINGS (INCLUDES F-142 FERRULES)						
F-300x	Fingertight Fitting for 1/16" OD Tubing	10-32 Coned	6,000 psi (414 bar)	Double Wing	PEEK Natural	10-pk
F-330x	Fingertight Fitting for 1/16" OD Tubing, Long	10-32 Coned	6,000 psi (414 bar)	Standard Knurl	PEEK Natural	10-pk
F-331x	Fingertight Fitting for 1/16" OD Tubing	10-32 Coned	6,000 psi (414 bar)	Standard Knurl	PEEK Natural	10-pk
REPLACEMENT FERRULES						
F-113	Ferrule for 1/32" OD Tubing	10-32 Coned	6,000 psi (414 bar)	—	PEEK Natural	ea.
F-142	Ferrule for 1/16" OD Tubing	10-32 Coned	6,000 psi (414 bar)	—	PEEK Natural	ea.
F-142N	Ferrule for 1/16" OD Tubing	10-32 Coned	4,000 psi (276 bar)	—	ETFE Natural	ea.
F-148	Ferrule for 190 µm OD tubing	10-32 Coned	6,000 psi (414 bar)	—	PCTFE Natural	ea.
F-151	Ferrule for 360 µm OD Tubing	10-32 Coned	6,000 psi (414 bar)	—	PCTFE Natural	ea.
M-215	Conductive Ferrule for 360 µm OD tubing	10-32 Coned	1,500 psi (103 bar)	—	Conductive Perfluoroelastomer	ea.



Two-Piece SealTight™ Fingertight Fittings

- › Several nut lengths and head styles to fit into a variety of applications
- › Designed to connect 1/16" OD tubing to 10-32 coned ports
- › Hold up to 9,000 psi (620 bar)

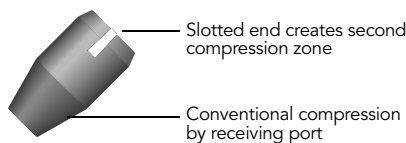

NOTE

Overtightening these fittings on fluoropolymer (e.g., FEP, PFA, and ETFE) tubing can cause the ID of your tubing to collapse.

RELATED PRODUCTS

- › Find tightening tools for these fittings on page 50.
- › Try the F-350x FlushNut™ for the ultimate streamline design.

The dual compression created by the specially designed nut and ferrule enables our SealTight™ Fittings system to outperform standard finger tightened fittings. The forward cone of the SealTight Ferrule provides gripping power and a leak-free seal via conventional compression by the receiving port. The slotted end creates the second compression zone in conjunction with a SealTight Nut. All SealTight Nuts are for use with 1/16" OD tubing and are designed to be used with the F-192x Ferrule. A wide variety of fitting head styles are available for various space constraints.

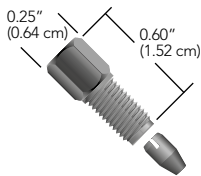

F-193x
10-32 Short PEEK Hex Head Nut, with F-192x Ferrule

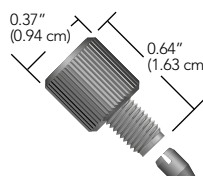

F-195x
10-32 Short PEEK Nut, with F-192x Ferrule

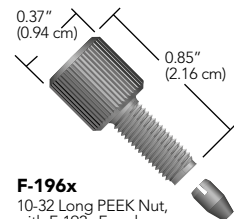

F-196x
10-32 Long PEEK Nut, with F-192x Ferrule

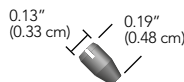

F-192x
SealTight Ferrule, for 1/16" OD tubing

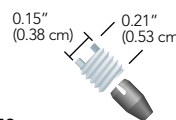

F-350x
10-32 Stainless Steel FlushNut, with F-192x Ferrule

Part No.	Description	Port	Pressure Rating	Head Style	Material	Qty.
SEALTIGHT TWO-PIECE FITTINGS (INCLUDES F-192 FERRULES)						
F-193x	SealTight Fitting for 1/16" OD Tubing, Short	10-32 Coned	7,000–9,000 psi (483–620 bar)	1/4" Hex	PEEK Black	10-pk
F-195x	SealTight Fitting for 1/16" OD Tubing, Short	10-32 Coned	7,000–9,000 psi (483–620 bar)	Standard Knurl	PEEK Black	10-pk
F-196x	SealTight Fitting for 1/16" OD Tubing, Long	10-32 Coned	7,000–9,000 psi (483–620 bar)	Standard Knurl	PEEK Black	10-pk
F-287x	SealTight Fitting for 1/16" OD Tubing, Long	10-32 Coned	7,000–9,000 psi (483–620 bar)	Knurl-1/4" Hex	PEEK Black	10-pk
F-350x	SealTight Fitting for 1/16" OD Tubing, FlushNut	10-32 Coned	7,000–9,000 psi (483–620 bar)	FlushNut	SST	10-pk
REPLACEMENT FERRULES						
F-192x	SealTight Ferrule for 1/16" OD Tubing	10-32 or M6 Coned	7,000–9,000 (483–620 bar)	—	PEEK/Black	10-pk



NanoTight™ Fittings & Sleeves

- › For connecting 1/16" OD or capillary tubing using tubing sleeves to standard 10-32 coned ports
- › Multiple nut styles available
- › Nuts manufactured from PEEK polymer, ferrules manufactured from ETFE



RELATED PRODUCTS

- › Find tightening tools for these head styles on page 50.
- › NanoTight Tubing sleeves start on page 52.

NanoTight™ Fittings and Sleeves are designed to connect 70 µm–1 mm OD capillary tubing to any standard 10-32 coned port normally intended for 1/16" OD tubing using the NanoTight Tubing Sleeves on page 52. The fittings can also be used to connect any 1/16" OD tubing. The ETFE ferrule material is softer than PEEK, making it a good candidate for connecting thin walled semi-rigid tubing such as FEP and ETFE into 10-32 ports with minimal constricting to the inner diameter.

Select from our expansive line of PEEK NanoTight Fittings, featuring several head style and length options. Each 10-pack of nuts includes ten ETFE F-142Nx ferrules.

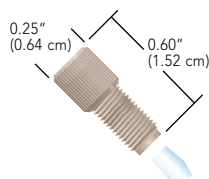

F-333Nx
Short Headless Nut
with F-142Nx Ferrule

Part No.	Description	Port	Pressure Rating	Head Style	Material (Nut/Ferrule)	Qty.
NANOTIGHT FITTINGS (INCLUDES F-142N FERRULES)						
F-333Nx	NanoTight Fitting for 1/16" OD Tubing and NanoTight Sleeves, Short	10-32 Coned	4,000 psi (276 bar)	Headless Knurl	PEEK Natural/ETFE Natural	10-pk
REPLACEMENT FERRULES						
F-142Nx	NanoTight Ferrule for 1/16" OD Tubing and NanoTight Sleeves	10-32 Coned	4,000 psi (276 bar)	—	ETFE Natural	10-pk

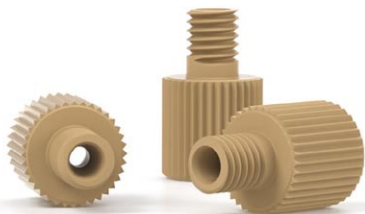

LiteTouch® Fittings

- › Helps prevent twisting of polymer tubing
- › High pressure with fingertight convenience
- › Options available for 1/32", 1/16", or 1/8" OD tubing

LITETOUCH FITTINGS SYSTEMS

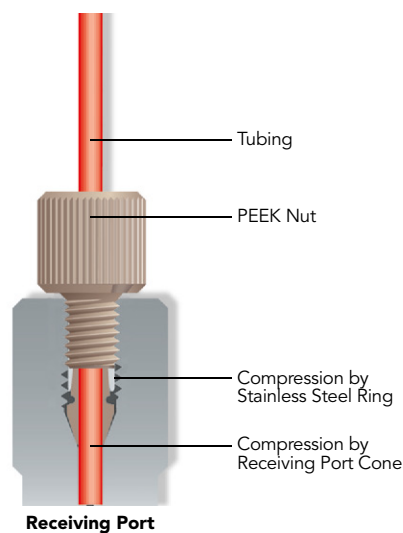

The LiteTouch® Fittings System grips tubing at two compression points (see diagram), holding to high pressures with Fingertight convenience. It also prevents polymer tubing from twisting, a potential problem when using standard Fingertight fittings. LiteTouch Fittings are available for use with 1/32", 1/16", or 1/8" OD tubing sizes, and for 10-32 or 1/4-28 coned ports.

For those space-limited applications where nut heads interfere with each other, try the FlushNut™ Fittings. (FlushNut Fittings require a tightening tool. Please see page 50 for more information about these products.)

To avoid collapsing the ID of your tubing, the LiteTouch system can be used on hard tubing only, such as stainless steel and PEEK polymer tubing. The LiteTouch Ferrule System is not recommended for repeated use in plastic ports.

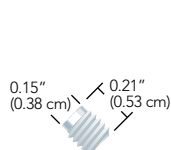

F-354x
10-32 Stainless Steel FlushNut for 1/32" and 1/16" OD tubing

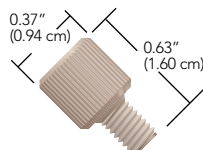

LT-110x
10-32 PEEK Nut for 1/32" and 1/16" OD tubing

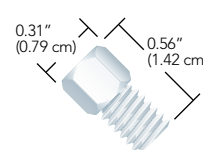

C-235x
1/4-28 Stainless Steel Nut for 1/8" OD tubing

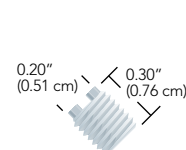

F-364x
1/4-28 Stainless Steel FlushNut for 1/8" OD tubing

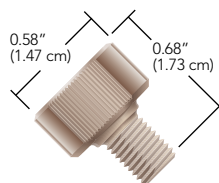

LT-210x
1/4-28 PEEK Double-Winged Nut for 1/8" OD tubing



LT-132x
PEEK Ferrule with Stainless Steel Lock Ring for 1/32" OD tubing



LT-100x
PEEK Ferrule with Stainless Steel Lock Ring for 1/16" OD tubing

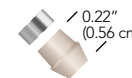

LT-200x
PEEK Ferrule with Stainless Steel Lock Ring for 1/8" OD tubing

RELATED PRODUCTS

- › The stainless steel nuts on page 59 can also be used with the LiteTouch ferrules on this page.

Part No.	Description	Port	Pressure Rating	Head Style	Material	Qty.
LITETOUCH NUTS						
C-235x	LiteTouch Nut for 1/8" OD Tubing	1/4-28 Coned	4,500 psi (310 bar)	5/16" Hex	SST	10-pk
F-354x	LiteTouch Nut for 1/16" or 1/32" OD Tubing, FlushNut	10-32 Coned	5,000 psi (345 bar)	FlushNut	SST	10-pk
F-364x	LiteTouch Nut for 1/8" OD Tubing, FlushNut	1/4-28 Coned	4,500 psi (310 bar)	FlushNut	SST	10-pk
LT-110x	LiteTouch Nut for 1/16" or 1/32" OD Tubing	10-32 Coned	5,000 psi (345 bar)	Standard Knurl	PEEK Natural	10-pk
LT-210x	LiteTouch Nut for 1/8" OD Tubing	1/4-28 Coned	4,500 psi (310 bar)	Double Wing	PEEK Natural	10-pk
LITETOUCH FERRULES						
LT-100x	LiteTouch Ferrule for 1/16" OD Tubing	10-32 Coned	5,000 psi (345 bar)	—	PEEK Natural/SST	10-pk
LT-132x	LiteTouch Ferrule for 1/32" OD Tubing	10-32 Coned	5,000 psi (345 bar)	—	PEEK Natural/SST	10-pk
LT-200x	LiteTouch Ferrule for 1/8" OD Tubing	1/4-28 Coned	4,500 psi (310 bar)	—	PEEK Natural/SST	10-pk

* When used with a stainless steel 10-32 nut from page 59.



Super Flangeless™ Fittings

- › Highest pressure holding flat-bottom fitting system we offer
- › Eliminates loosening of fittings due to tubing twist
- › Excellent for Tubing Assemblies
- › Holds tight even through vibration

★ ASSEMBLY HINT

Make sure the locking ring is oriented correctly! The flattened end of the ring should face towards the nut with the narrow end of the ferrule towards the ring.

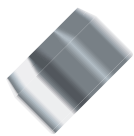

Enlarged to show detail

📄 SUPER FLANGELESS FITTINGS SYSTEM

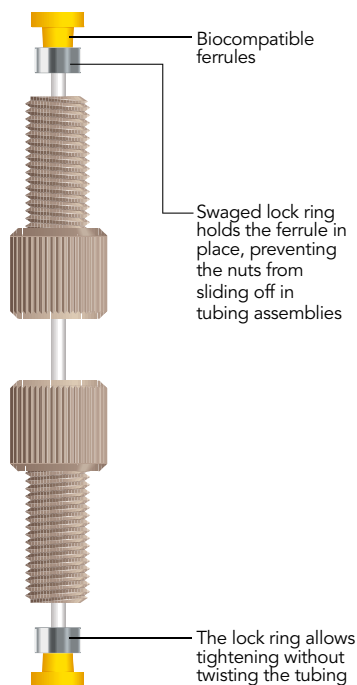

Our Super Flangeless™ Fittings provide the highest pressure holding capability in a flat-bottom fitting system that we offer. Our unique design eliminates loosening of fittings due to tubing twist and holds tight even through vibration. Our high pressure fittings are excellent for tubing assemblies and those times when connections need to be broken frequently.

6-40 & 6-32 options (for 1-16" OD tubing)

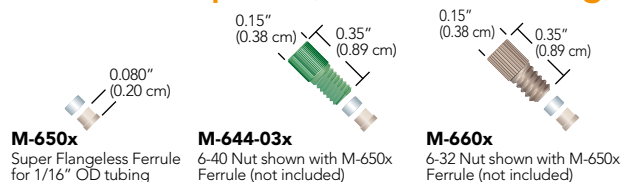

10-32 options (for 1-16" OD tubing)

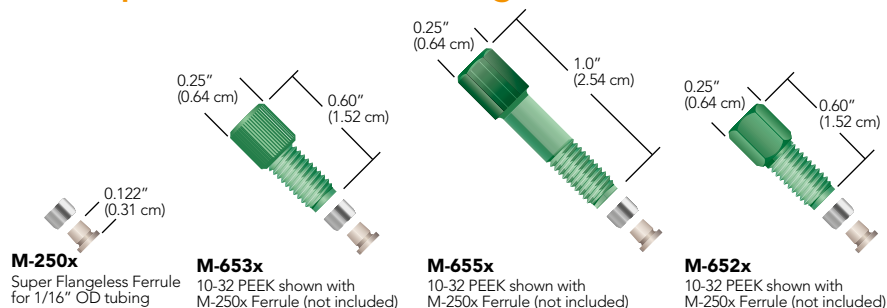

Ferrules for M6x1, 1/4-28, 5/16-24

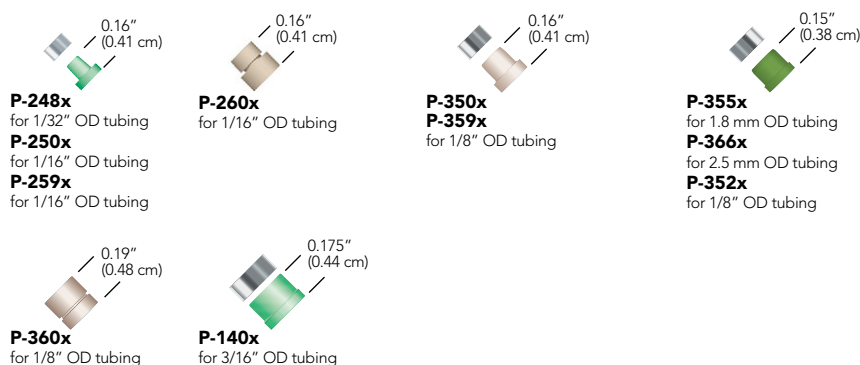

Super Flangeless™ Fittings (Cont.)

M6x1, 1/4-28, 5/16-24 Options for 1/32"–3/16" OD Tubing

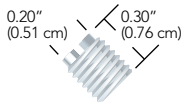

F-356x
(1/4-28, ≤ 1/16" OD Tubing)
F-364x
(1/4-28, > 1/16" OD Tubing)

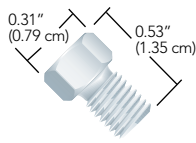

LT-105x
(1/4-28, ≤ 1/16" OD Tubing)
C-235x
(1/4-28, > 1/16" OD Tubing)

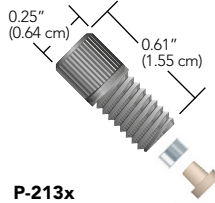

P-213x
(M6X1, ≤ 1/16" OD Tubing)
P-337x
(M6X1, > 1/16" OD Tubing)
P-232x
(1/4-28, ≤ 1/16" OD Tubing)
P-336x
(1/4-28, > 1/16" OD Tubing)

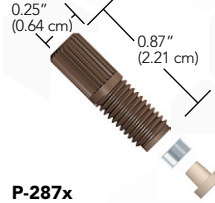

P-287x
(1/4-28, ≤ 1/16" OD Tubing)
P-387x
(1/4-28, > 1/16" OD Tubing)

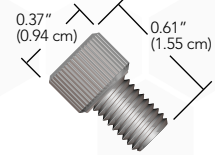

P-219x
(M6X1, ≤ 1/16" OD Tubing)
P-319x
(M6X1, > 1/16" OD Tubing)
LT-115x
(1/4-28, ≤ 1/16" OD Tubing)

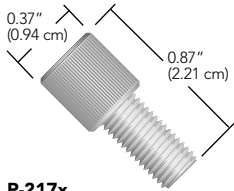

P-217x
(M6X1, ≤ 1/16" OD Tubing)
P-317x
(M6X1, > 1/16" OD Tubing)
P-246x, P-255x, P-281x
(1/4-28, ≤ 1/16" OD Tubing)
P-331x, P-381x
(1/4-28, > 1/16" OD Tubing)

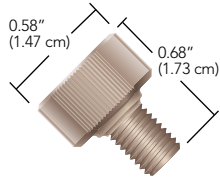

LT-210x
(1/4-28, > 1/16" OD Tubing)

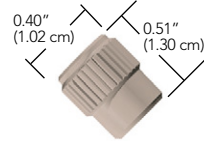

P-420x
(1/4-28, ≤ 1/16" OD Tubing)
F-156x
(1/4-28, > 1/16" OD Tubing)

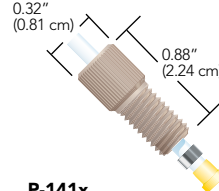

P-141x
(5/16-24, ≤ 1/16" OD Tubing)
P-137x
(5/16-24, 3/16" OD Tubing)

One-Piece Super Flangeless™ Fittings

- › All-PEEK construction
- › For 1/16" OD and 1/8" OD tubing
- › M6x1 and 1/4-28 options
- › Finger tight (2–3 in-lbs / 0.23–0.34 N·m)
- › Extremely easy to use
- › Reusable one piece design that requires no swaging

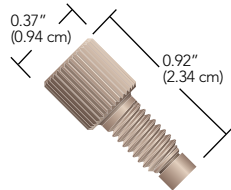

P-329x
M6X1, for 1/8" OD Tubing
P-249x
1/4-28, for 1/16" OD Tubing
P-349x
1/4-28, for 1/8" OD Tubing

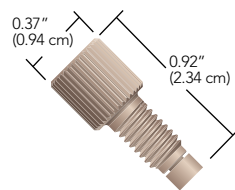

P-229x
M6X1, for 1/16" OD Tubing

Super Flangeless Tubing OD / Thread Comparison

	1/32"	1/16"	1.8 MM	2.5 MM	1/8"	3/16"
6-40		✓				
6-32		✓				
10-32		✓				
M6x1	✓	✓	✓	✓	✓	
1/4-28	✓	✓	✓	✓	✓	
5/16-24						✓

Super Flangeless™ and One-Piece Super Flangeless Fittings

Part No.	Description	Port	Pressure Rating	Head Style	Material	Qty.
SUPER FLANGELESS FERRULES FOR 1/32", 1/16", 1/8", 3/16", 1.8MM, 2.0MM, 2.5MM						
M-250x	Super Flangeless Ferrule for 1/16" OD Tubing	10-32 Flat-Bottom	1,000–5,000 psi (69–345 bar)	—	PEEK Natural/SST	10-pk
M-650x	Super Flangeless Ferrule for 1/16" OD Tubing	6-32 or 6-40 Flat Bottom	750–3,750 psi (52–259 bar)	—	PEEK Natural/SST	10-pk
P-248x	Super Flangeless Ferrule for 1/32" OD Tubing	10-32 Flat-Bottom	2,500 psi (172 bar)	—	ETFE Green/SST	10-pk
P-250x	Super Flangeless Ferrule for 1/16" OD Tubing	1/4-28 or M6 Flat Bottom	2,500 psi (172 bar)	—	PEEK Natural/SST	10-pk
P-259x	Super Flangeless Ferrule for 1/16" OD Tubing	1/4-28 or M6 Flat Bottom	1,350 psi (93 bar)	—	ETFE Yellow/SST	10-pk
P-260x	Super Flangeless Ferrule for 1/16" OD Tubing	1/4-28 or M6 Flat Bottom	1,850 psi (128 bar)	—	PEEK Natural/SST	10-pk
P-350x	Super Flangeless Ferrule for 1/8" OD Tubing	1/4-28 Flat Bottom	2,500 psi (172 bar)	—	PEEK Natural/SST	10-pk
P-352x	Super Flangeless Ferrule for 1/16" OD Tubing	1/4-28 or M6 Flat Bottom	2,500 psi (172 bar)	—	PEEK Black/SST	10-pk
P-355x	Super Flangeless Ferrule for 1.8 mm OD Tubing	1/4-28 or M6 Flat Bottom	2,500 psi (172 bar)	—	PCTFE Green/SST	10-pk
P-357-2x	Super Flangeless Ferrule for 2.0 mm OD Tubing	M6 Flat Bottom	5,000 psi (345 bar)	—	PEEK Natural/SST	10-pk
P-359x	Super Flangeless Ferrule for 1/8" OD Tubing	1/4-28 Flat Bottom	1,000 psi (69 bar)	—	ETFE Yellow/SST	10-pk
P-360x	Super Flangeless Ferrule for 1/8" OD Tubing	1/4-28 Flat Bottom	1,500 psi (102 bar)	—	PEEK Natural/SST	10-pk
P-366x	Super Flangeless Ferrule for 2.5" OD Tubing	1/4-28 Flat Bottom	1,000 psi (69 bar)	—	PEEK Natural/SST	10-pk
P-140x	Super Flangeless Ferrule for 3/16" OD Tubing	5/16-24 Flat Bottom	500 psi (34 bar)	—	ETFE Green/SST	10-pk
6-40 AND 6-32 FITTINGS FOR 1/16" OD TUBING						
M-660x	Super Flangeless Nut for 1/16" OD Tubing	6-32 Flat Bottom	750–3,750 psi (52–259 bar)	Micro Headless	PEEK Natural	10-pk
M-644-03x	Super Flangeless Nut for 1/16" OD Tubing	6-40 Flat Bottom	750–3,750 psi (52–259 bar)	Micro Headless	PEEK Green	10-pk
10-32 FITTINGS FOR 1/16" OD TUBING						
M-652x	Super Flangeless Nut for 1/16" OD Tubing	10-32 Flat Bottom	1,000–5,000 psi (69–345 bar)	1/4" Hex	PEEK Green	10-pk
M-653x	Super Flangeless Nut for 1/16" OD Tubing	10-32 Flat Bottom	1,000–5,000 psi (69–345 bar)	Headless Knurl	PEEK Green	10-pk
M-655x	Super Flangeless Nut for 1/16" OD Tubing, Long	10-32 Flat Bottom	1,000–5,000 psi (69–345 bar)	1/4" Hex	PEEK Green	10-pk
M6X1 FITTINGS FOR 1/16" AND 1/32" OD TUBING						
P-213x	Super Flangeless Nut for 1/16" or 1/32" OD Tubing, Short	M6 Flat Bottom	*	Headless Knurl	PEEK Black	10-pk
P-217x	Super Flangeless Nut for 1/16" or 1/32" OD Tubing	M6 Flat Bottom	*	Standard Knurl	PPS Black	10-pk
P-219x	Super Flangeless Nut for 1/16" or 1/32" OD Tubing, Short	M6 Flat Bottom	*	Standard Knurl	PEEK Black	10-pk
M6X1 FITTINGS FOR 1.8 MM, 2.0 MM, 2.5 MM, 1/8" OD TUBING						
P-317x	Super Flangeless For >1/16"–≤ 1/8" OD Tubing	M6 Flat Bottom	*	Standard Knurl	PPS Black	10-pk
P-319x	Super Flangeless Nut for 1/8" OD Tubing, Short	M6 Flat Bottom	*	Standard Knurl	PEEK Black	10-pk
P-337x	Super Flangeless For >1/16"–≤ 1/8" OD Tubing, Short	M6 Flat Bottom	*	Headless Knurl	PEEK Black	10-pk
P-357x	Super Flangeless Fitting for 2.0 mm OD Tubing	M6 Flat Bottom	*	Standard Knurl	PEEK Black, Natural/SST	10-pk
1/4-28 FITTINGS FOR 1/16" AND 1/32" OD TUBING						
F-356x	Super Flangeless Nut for 1/16" or 1/32" OD Tubing, FlushNut	1/4-28 Flat Bottom	*	FlushNut	SST	10-pk
LT-105x	Super Flangeless Nut for 1/16" or 1/32" OD Tubing, Short	1/4-28 Flat Bottom	*	1/4" Hex	SST	10-pk
LT-115x	Super Flangeless Nut for 1/16" or 1/32" OD Tubing, Short	1/4-28 Flat Bottom	*	Standard Knurl	PEEK Natural	10-pk
P-232x	Super Flangeless Nut for 1/16" or 1/32" OD Tubing, Short	1/4-28 Flat Bottom	*	Headless Knurl	PEEK Natural	10-pk
P-246x	Super Flangeless Nut for 1/16" or 1/32" OD Tubing	1/4-28 Flat Bottom	*	Standard Knurl	PFA Natural	10-pk
P-255x	Super Flangeless Nut for 1/16" or 1/32" OD Tubing	1/4-28 Flat Bottom	*	Standard Knurl	PEEK Natural	10-pk
P-281x	Super Flangeless Nut for 1/16" or 1/32" OD Tubing	1/4-28 Flat Bottom	*	Standard Knurl	PPS Natural	10-pk
P-287x	Super Flangeless Nut for 1/16" or 1/32" OD Tubing	1/4-28 Flat Bottom	*	Headless Knurl	PPS Natural	10-pk
P-420x	Super Flangeless Nut for 1/16" or 1/32" OD Tubing, Female	1/4-28 Flat Bottom	*	Female Knurl	PEEK Natural	10-pk
1/4-28 FITTINGS FOR 1.8MM, 2.5 MM, 1/8" OD TUBING						
C-235x	Super Flangeless Nut for 1/8" OD Tubing	1/4-28 Flat Bottom	*	1/4" Hex	SST	10-pk
F-156x	Super Flangeless Nut for 1/8" OD Tubing, Female	1/4-28 Flat Bottom	*	Female Knurl	PEEK Black	10-pk
F-364x	Super Flangeless Nut for 1/8" OD Tubing, FlushNut™	1/4-28 Flat Bottom	*	FlushNut	SST	10-pk
LT-210x	Super Flangeless Nut for 1/8" OD Tubing	1/4-28 Flat Bottom	*	Double Wings	PEEK Natural	10-pk
P-331x	Super Flangeless Nut for 1/8" OD Tubing	1/4-28 Flat Bottom	*	Standard Knurl	PEEK Natural	10-pk
P-336x	Super Flangeless Nut for 1/8" OD Tubing, Short	1/4-28 Flat Bottom	*	Headless Knurl	PEEK Natural	10-pk
P-381x	Super Flangeless Nut for 1/8" OD Tubing	1/4-28 Flat Bottom	*	Standard Knurl	PPS Natural	10-pk
P-387x	Super Flangeless Nut for 1/8" OD Tubing	1/4-28 Flat Bottom	*	Standard Knurl	PPS Natural	10-pk
5/16-24 FITTINGS FOR 1/16", 1/8", 3/16" OD TUBING						
P-137x	Super Flangeless Fitting for 3/16" OD Tubing	5/16-24 Flat Bottom	*	Standard Knurl	PEEK Black	10-pk
P-141x	Super Flangeless Fitting for 1/16" OD Tubing	5/16-24 Flat Bottom	*	Standard Knurl	PEEK Natural	10-pk
ONE-PIECE SUPER FLANGELESS FITTINGS FOR 1/16" AND 1/8" OD TUBING						
P-229x	One Piece Super Flangeless Fitting for 1/16" OD Tubing	M6 Flat Bottom	1,000 psi (69 bar)	Standard Knurl	PEEK	10-pk
P-249x	One Piece Super Flangeless Fitting for 1/16" OD Tubing	1/4-28 Flat Bottom	1,000 psi (69 bar)	Standard Knurl	PEEK	10-pk
P-329x	One Piece Super Flangeless Fitting for 1/16" OD Tubing	M6 Flat Bottom	1,000 psi (69 bar)	Standard Knurl	PEEK	10-pk
P-349x	One Piece Super Flangeless Fitting for 1/16" OD Tubing	1/4-28 Flat Bottom	1,000 psi (69 bar)	Standard Knurl	PEEK	10-pk

* Pressure rating of nut depends on the ferrule used.



VacuTight™ Fittings

- › For 1/16" or 1/8" OD tubing connections into 10-32, 1/4-28, or M6 flat-bottom ports
- › Vacuum Rated to 25 in-Hg (84 kPa)
- › Improve transfer volume consistency

VacuTight Fittings are designed to provide airtight, dependable connections under vacuum and low pressure conditions. Many of the VacuTight Nuts have streamlined profiles for use in systems requiring a large number of connections in a small area. Furthermore, the VacuTight Ferrule's small size ensures sufficient nut/thread engagement, even in shallow ports. These features make VacuTight Fittings ideal for "combi-chem" high throughput screening, clinical diagnostic, and other automated liquid handling applications.

The configuration of the VacuTight flat-bottom ferrules prevents overcompression and tubing ID reduction that can occur with many coned fittings. The result is more consistent aspirating and dispensing volumes across all system connections.

The VacuTight fittings can also work well in some positive pressure applications. The pressure range for each fitting is listed below and depends upon the tubing used for the connection. Please contact your distributor or IDEX Health & Science for more information. Additionally, please note that some of the VacuTight fittings have changed in color from red to black; however, this color change does not affect product performance.

All VacuTight Nuts must be used exclusively with VacuTight Ferrules.

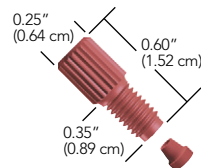

P-844x
PEEK Nut, 10-32
with P-840 Ferrule



P-846x
PEEK Nut, 10-32
with P-840 Ferrule

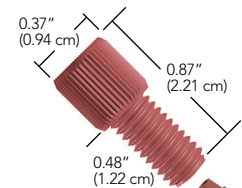

P-930x¹
Delrin® Nut, 1/4-28
with P-840 Ferrule

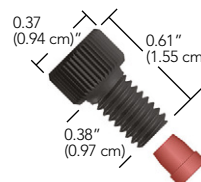

P-945x²
Delrin Nut, M6
with P-940 Ferrule

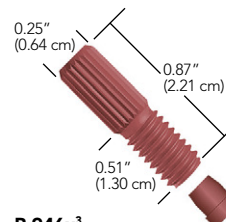

P-946x³
Delrin Nut, 1/4-28
with P-940 Ferrule

¹ The dimensions shown apply to P-930x, P-931x, P-938x, P-942x, and P-948x.

² The dimensions shown apply to P-945x.

³ The dimensions shown apply to P-946x.

Part No.	Description	Port	Pressure Rating	Head Style	Material	Qty.
VACUTIGHT FITTINGS (INCLUDES P-840 OR P-940 FERRULES)						
P-842x	VacuTight Fitting for 1/16" OD Tubing, Short	10-32 Flat-Bottom	400–800 psi (27–55 bar)	1/4" Hex	PEEK Red	10-pk
P-844x	VacuTight Fitting for 1/16" OD Tubing, Short	10-32 Flat-Bottom	400–800 psi (27–55 bar)	Headless Knurl	PEEK Red	10-pk
P-846x	VacuTight Fitting for 1/16" OD Tubing, Long	10-32 Flat-Bottom	400–800 psi (27–55 bar)	Headless Knurl	PEEK Red	10-pk
P-930x	VacuTight Fitting for 1/16" OD Tubing	1/4-28 Flat-Bottom	400–800 psi (27–55 bar)	Standard Knurl	Delrin Red	10-pk
P-931x	VacuTight Fitting for 1/16" OD Tubing	M6 Flat-Bottom	400–800 psi (27–55 bar)	Standard Knurl	Delrin Red	10-pk
P-938x	VacuTight Fitting for 1/16" OD Tubing	1/4-28 Flat-Bottom	400–800 psi (27–55 bar)	Standard Knurl	PEEK Natural	10-pk
P-942x	VacuTight Fitting for 1/8" OD Tubing	1/4-28 Flat-Bottom	500–1,000 psi (34–69 bar)	Standard Knurl	Delrin Red	10-pk
P-945x	VacuTight Fitting for 1/8" OD Tubing, Short	M6 Flat-Bottom	500–1,000 psi (34–69 bar)	Standard Knurl	Delrin Black	10-pk
P-946x	VacuTight Fitting for 1/8" OD Tubing	1/4-28 Flat-Bottom	500–1,000 psi (34–69 bar)	Headless Knurl	Delrin Red	10-pk
P-948x	VacuTight Fitting for 1/8" OD Tubing	1/4-28 Flat-Bottom	500–1,000 psi (34–69 bar)	Standard Knurl	PEEK Natural	10-pk
REPLACEMENT FERRULES						
P-840	VacuTight Ferrule for 1/16" OD Tubing	M6 or 1/4-28 Flat-Bottom	400–800 psi (27–55 bar)	—	ETFE Red	ea.
P-940x	VacuTight Ferrule for 1/8" OD Tubing	M6 or 1/4-28 Flat-Bottom	500–1,000 psi (34–69 bar)	—	ETFE Red	10-pk

Metric Flangeless Fittings

- › For 1/16", 1.8 mm, 2.0 mm, 2.5 mm, 3.0 mm, 4.0 mm, or 1/8" OD tubing
- › Convenience of flangeless fittings for metric tubing sizes and M6 flat-bottom ports

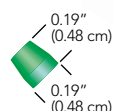

P-342x
ETFE Ferrule
for 1.8 OD tubing

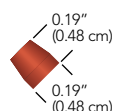

P-363Rx
ETFE Ferrule
for 2.0 mm OD tubing

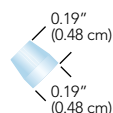

P-353x
ETFE Ferrule
for 2.5 mm OD tubing

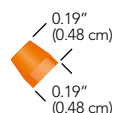

P-343x
ETFE Ferrule
for 3.0 mm OD tubing

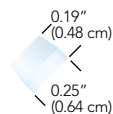

P-344x
ETFE Ferrule
for 4.0 mm OD tubing

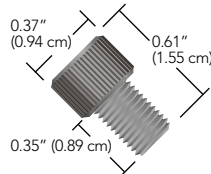

P-347x
PEEK Nut
for 1.8, 2.0, 3.0 mm or
1/8" OD tubing

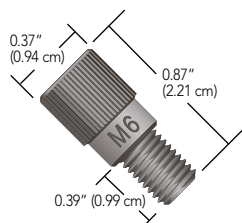

P-207x
Delrin® Nut
for 1/16" OD tubing

Metric Flangeless Ferrules are designed to connect 1.8, 2.0, 2.5, 3.0, or 4.0 mm OD tubing to flat-bottom ports when paired with the appropriate M6, 1/4-28, or 5/16-24 Flangeless Nuts. We also offer M6-threaded nuts to connect 1/16" or 1/8" OD tubing, plus a tubing sleeve to facilitate 1.0 mm OD tubing connections. Please refer to the "Metric Connections" chart on this page for information regarding which nuts and ferrules to use with your tubing.



METRIC CONNECTIONS

Use this chart to determine the low pressure fittings needed to connect metric and English-sized tubing into the indicated ports.

Tubing Size	Port	Ferrules	Nuts
1.0 mm	M6 1/4-28	P-200x (w/F-252 sleeve, not included) P-200x (w/F-252 sleeve, not included)	P-207x, P-207Sx, P-247x Any 1/4-28 nut for 1/16" OD tubing from page 47
1.8 mm	M6 1/4-28	P-342x P-342x	P-307x, P-307Sx, P-347x Any 1/4-28 nut for 1/8" OD tubing from page 47
2.0 mm	M6 1/4-28	P-363Rx P-363Rx	P-307x, P-307Sx, P-347x Any 1/4-28 nut for 1/8" OD tubing from page 47
2.5 mm	M6 1/4-28	P-353x P-353x	P-307x, P-307Sx, P-347x Any 1/4-28 nut for 1/8" OD tubing from page 47
3.0 mm	M6 1/4-28	P-343x P-343x	P-307x, P-307Sx, P-347x Any 1/4-28 nut for 1/8" OD tubing from page 47
4.0 mm	5/16-24	P-344x	XP-132x from page 56
1/16"	M6 M6	P-200x P-840	P-207x, P-207Sx, P-247x, P-931, page 42
1/8"	M6 M6	P-300x P-940x	P-307x, P-307Sx, P-347x, P-945x, page 42



RELATED PRODUCTS

MORE METRIC-SIZED PRODUCTS	Page	Page
High Pressure Polymer Fittings	58	Low Pressure Unions 84
High Pressure Stainless Steel Fittings	59	Bulkhead Unions 82
Luer Adapters	87	PEEK (1.8 mm OD and Capillary) and Fused Silica Tubing 16
Metric Threaded Adapters	65	PEEKsil™ Tubing 22
External NPT Adapters	66	FEP Tubing (1.0–4.0 mm OD) and PFA Capillary Tubing 26
VacuTight™ Fittings	42	Frit-In-A-Ferrule™ 99
Plugs and Caps	55	

In addition, many of our 1/4-28 threaded Filters, Valves and Flow Control Accessories can be converted to accept 1.8, 2.0, 2.5 and 3.0 mm tubing, using the ferrules listed for 1/4-28 ports in the "Metric Connections" table, this page.

Part No.	Description	Port	Pressure Rating	Head Style	Material	Qty.
METRIC FLANGELESS NUTS						
P-207x	Flangeless Nut for 1/16" OD Tubing	M6 Flat-Bottom	2,000 psi (138 bar)	Standard Knurl	Delrin Black	10-pk
P-2075x	Flangeless Nut for 1/16" OD Tubing, Short	M6 Flat-Bottom	2,000 psi (138 bar)	Standard Knurl	Delrin Black	10-pk
P-247x	Flangeless Nut for 1/16" OD Tubing, Short	M6 Flat-Bottom	2,000 psi (138 bar)	Standard Knurl	PEEK Black	10-pk
P-307x	Flangeless Nut for 1.8 mm, 2.0 mm, 3.0 mm, 1/8" OD Tubing	M6 Flat-Bottom	500 psi (34 bar)	Standard Knurl	Delrin Black	10-pk
P-3075x	Flangeless Nut for 1.8 mm, 2.0 mm, 3.0 mm, 1/8" OD Tubing	M6 Flat-Bottom	500 psi (34 bar)	Standard Knurl	Delrin Black	10-pk
P-347x	Flangeless Nut for 1.8 mm, 2.0 mm, 3.0 mm, 1/8" OD Tubing	M6 Flat-Bottom	500 psi (34 bar)	Standard Knurl	PEEK Black	10-pk
FLANGELESS FERRULES						
F-252x	1/16" OD Tubing Sleeve for 1.0 mm ID Tubing	M6 or 1/4-28 Flat-Bottom	500 psi (34 bar)	—	FEP Purple	10-pk
P-200x	Flangeless Ferrule for 1/16" OD Tubing	M6 or 1/4-28 Flat-Bottom	2,000 psi (138 bar)	—	ETFE Blue	10-pk
P-300x	Flangeless Ferrule for 1/8" OD Tubing	M6 or 1/4-28 Flat-Bottom	500 psi (34 bar)	—	ETFE Yellow	10-pk
P-342x	Flangeless Ferrule for 1.8 mm OD Tubing	M6 or 1/4-28 Flat-Bottom	500 psi (34 bar)	—	ETFE Green	10-pk
P-343x	Flangeless Ferrule for 3.0 mm OD Tubing	M6 or 1/4-28 Flat-Bottom	500 psi (34 bar)	—	ETFE Orange	10-pk
P-344x	Flangeless Ferrule for 4.0 mm OD Tubing	5/16-24	250 psi (17 bar)	—	ETFE Natural	10-pk
P-353x	Flangeless Ferrule for 2.5 mm OD Tubing	M6 or 1/4-28 Flat-Bottom	500 psi (34 bar)	—	ETFE Natural	10-pk
P-363Rx	Flangeless Ferrule for 2.0 mm OD Tubing	M6 or 1/4-28 Flat-Bottom	500 psi (34 bar)	—	ETFE Red	10-pk



Flanged Fittings

- › Fittings for 1/16" or 1/8" OD tubing, supplied with nut and 316 stainless steel washer
- › Multiple head styles and materials available; contact IDEX Health & Science for more information
- › For 1/4-28 and M6 flat-bottom ports
- › Some color options available; call for more information

Flanged Fittings are compatible with most standard 1/4-28 or M6 Flat-Bottom flanged fittings. The Delrin® (acetal resin) nut resists cross threading or loosening during use.

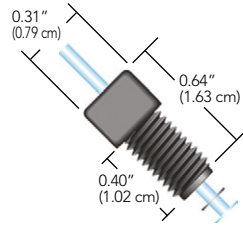

P-401x¹
Flanged Fitting for 1/16" OD tubing*

¹ The dimensions shown apply to all square-head Flanged Fittings

* Flanged tubing not included

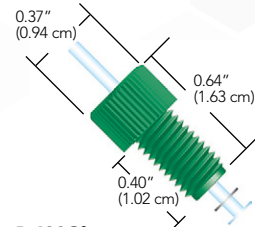

P-482G³
Flanged Fitting for 1/16" OD tubing*

³ The dimensions shown apply to all knurled-head Flanged Fittings

* Flanged tubing not included



RELATED PRODUCTS

- › For an alternative to flanging tubing, we highly recommend the Flangeless Fittings found on page 45, the Super Flangeless™ Fittings found on page 39, or the VacuTight™ Fittings on page 42.

Part No.	Description	Port Geometry	Head Style	Material (Nut/Washer)	Qty.
FLANGED FITTINGS (INCLUDES STAINLESS STEEL WASHERS)					
P-401x	Flanged Fitting for 1/16" OD Tubing	1/4-28 Flat-Bottom	5/16" Square	Delrin Black/SST	10-pk
P-482BLK	Flanged Fitting for 1/16" OD Tubing	1/4-28 Flat-Bottom	Standard Knurl	Delrin Black/SST	ea.
P-501x	Flanged Fitting for 1/8" OD Tubing	1/4-28 Flat-Bottom	5/16" Square	Delrin Black/SST	10-pk
P-982BLKx	Flanged Fitting for 1/16" OD Tubing	M6 Flat-Bottom	Standard Knurl	Delrin Black/SST	10-pk
P-1082BLKx	Flanged Fitting for 1/8" OD Tubing	M6 Flat-Bottom	Standard Knurl	Delrin Black/SST	10-pk
REPLACEMENT WASHERS					
P-407x	Washer for 1/16" OD Tubing	1/4-28 Flat-Bottom	—	SST	10-pk
P-507x	Washer for 1/8" OD Tubing	1/4-28 Flat-Bottom	—	SST	10-pk
P-1087x	Washer for 1/8" OD Tubing	M6 Flat-Bottom	—	SST	10-pk



Flangeless Fittings



THE CONVENIENCE OF FLANGELESS FITTINGS



Our Flangeless Nuts provide fingertight convenience — no wrenches required.

Our Flangeless Ferrules provide a leak-proof seal. There is no need to spend time flanging tubing.

Flangeless Fittings eliminate the need to flange tubing. This removable and reusable system provides several benefits:

Convenience: Flangeless Fittings are easy to use. Just slip the nut and ferrule over the tubing and finger tighten the assembly into your receiving port. In tests, it is shown that the ideal amount of torque to achieve expected part performance should be approximately 3–4 in-lbs (0.34–0.45 N·m). Check out the line of special tightening tools designed to adapt to many standard torque wrenches, on page 50 and the adjustable torque driver, VHP-4000 on page 51.

Minimal Down-Time: Component replacement is quick, taking only a few seconds — unlike the significant time required to flange tubing.

Cost-Effectiveness: Repairing a flanged tubing assembly requires a costly flanging tool or the purchase of a complete replacement assembly, including a new length of tubing and a set of fittings. The Flangeless Fittings system typically requires only one new ferrule at minimal cost when repairing a connection.

The 1/4-28 and M6 Flangeless Fittings for 1/16", 1/8", and metric sized OD tubing are summarized on the following page and listed on page 47.

1/4-28 Flangeless Fittings – Nuts

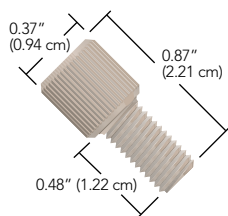

Standard

XP-201x
XP-202x
XP-220x
XP-230x
XP-238x
XP-245x
XP-301x – XP-305x
XP-330x

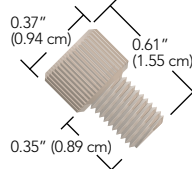

Short

XP-218x
XP-235x
XP-308x
XP-335x
P-207Sx
P-247x
P-307Sx
P-347x

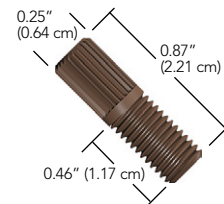

Headless

XP-286x

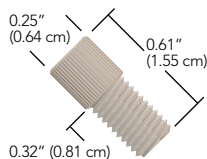

Short Headless

XP-283x

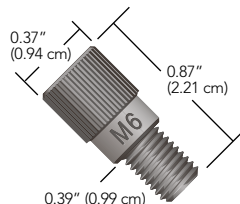

Standard Metric

P-207x
P-307x

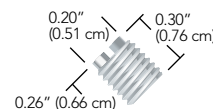

FlushNut™

XF-358x
XF-368x

Flangeless Fittings (Cont.)

NOTE

- › The XP-340x ferrule is designed for use with shallow receiving ports, such as those used on some low pressure valves.



XP-340x
ETFE Small Valve Ferrule

- › The XF-368x FlushNut is an excellent choice for applications where port-to-port spacing is limited; see page 31 for more information on this innovative product line. As an alternative, consider one of the "headless" fittings shown on this page.

Ferrules

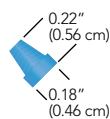

Standard 1/16"
P-200x
XP-200Nx

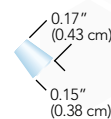

Small Valve 1/16"
XP-240x

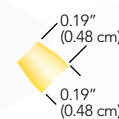

**Standard 1/8"
and Metric Ferrules**
XP-300x
XP-300Nx
P-342x
P-353x
P-363Rx
P-343x

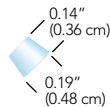

Small Valve 1/8"
XP-340x

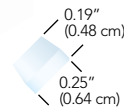

Standard 4.0 mm
P-344x

RELATED PRODUCTS

- › For the Large Bore Flangeless Fittings, please refer to page 56.
- › Nuts for M6 threaded ports are on page 43; nuts for 5/16-24 threaded ports are on page 56.

Flangeless Fittings for 1/16" and 1/8" OD Tubing

- › Wide variety of materials and geometries to fit most applications
- › Excellent replacement for flanged fittings
- › Convenient and easy to use
- › Fittings and ferrules packaged together for easy ordering convenience

Flangeless Fittings for 1/16" OD Tubing, and for 1/8" OD Tubing are available in a variety of materials. The replacement ferrules are manufactured from inert ETFE, and are sold in a colored version or ETFE's natural color as the N option. The smaller ferrules, XP-240x and XP-340x are designed for shallow ports.

The fittings shown on this page are packaged together with the ferrules in convenient 10-packs. The 1/16" version include the XP-200x ferrule, and the 1/8" version include the XP-300x ferrule. Please visit our website, www.idex-hs.com, for single packaging options.

For higher pressure and temperature applications consider our Super Flangeless™ found on page 39.

Lock Nut

The XP-312x Lock Nut is for use with any 1/4-28 male Flangeless Fitting. Use this product in applications where vibrations can loosen fittings.

To Use: Thread the lock nut onto the male fitting. When the male fitting is firmly seated into the receiving port, tighten the lock nut down against the receiving port to securely hold the male fitting in place.



XP-312x
Lock Nut White Delrin

Flangeless Fittings

Part No.	Description	Port	Pressure Rating	Head Style	Material	Qty.
FLANGELESS FITTINGS FOR 1/16" OD TUBING						
XF-358x	Flangeless Fitting for 1/16" OD Tubing, FlushNut	1/4-28 Flat-Bottom	2,000 psi (138 bar)	FlushNut	SST	10-pk
XLT-111x	Flangeless Fitting for 1/16" OD Tubing	10-32 Flat-Bottom	2,500 psi (172 bar)	Standard Knurl	PEEK Natural	10-pk
XP-201x	Flangeless Fitting for 1/16" OD Tubing	1/4-28 Flat-Bottom	2,000 psi (138 bar)	Standard Knurl	Delrin Black	10-pk
XP-202x	Flangeless Fitting for 1/16" OD Tubing	1/4-28 Flat-Bottom	2,000 psi (138 bar)	Standard Knurl	Delrin Red	10-pk
XP-218x	Flangeless Fitting for 1/16" OD Tubing	1/4-28 Flat-Bottom	2,000 psi (138 bar)	Standard Knurl	ETFE Natural	10-pk
XP-230x	Flangeless Fitting for 1/16" OD Tubing	1/4-28 Flat-Bottom	2,000 psi (138 bar)	Standard Knurl	PEEK Natural	10-pk
XP-235x	Flangeless Fitting for 1/16" OD Tubing, Short	1/4-28 Flat-Bottom	2,000 psi (138 bar)	Standard Knurl	PEEK Natural	10-pk
XP-238x	Flangeless Fitting for 1/16" OD Tubing	1/4-28 Flat-Bottom	2,000 psi (138 bar)	Standard Knurl	Delrin Purple	10-pk
XP-245x	Flangeless Fitting for 1/16" OD Tubing	1/4-28 Flat-Bottom	2,000 psi (138 bar)	Standard Knurl	PFA Natural	10-pk
XP-286x	Flangeless Fitting for 1/16" OD Tubing	1/4-28 Flat-Bottom	2,000 psi (138 bar)	Headless Knurl	PPS Natural	10-pk
REPLACEMENT FERRULES FOR 1/16" OD TUBING						
XP-200x	Flangeless Ferrule for 1/16" OD Tubing	1/4-28 Flat-Bottom	2,000 psi (138 bar)	—	ETFE Blue	10-pk
XP-200Nx	Flangeless Ferrule for 1/16" OD Tubing	1/4-28 Flat-Bottom	2,000 psi (138 bar)	—	ETFE Natural	10-pk
XP-240x	Flangeless Ferrule for 1/16" OD Tubing, Small Valve	1/4-28 or 10-32 Flat-Bottom	2,500 psi (172 bar)	—	ETFE Natural	10-pk
FLANGELESS FITTINGS FOR 1/8" OD TUBING (INCLUDES P-300 FERRULES)						
XF-368x	Flangeless Fitting for 1/8" OD Tubing, FlushNut	1/4-28 Flat-Bottom	500 psi (34 bar)	FlushNut	SST	10-pk
XP-301x	Flangeless Fitting for 1/8" OD Tubing	1/4-28 Flat-Bottom	500 psi (34 bar)	Standard Knurl	Delrin Black	10-pk
XP-302x	Flangeless Fitting for 1/8" OD Tubing	1/4-28 Flat-Bottom	500 psi (34 bar)	Standard Knurl	Delrin Red	10-pk
XP-305x	Flangeless Fitting for 1/8" OD Tubing	1/4-28 Flat-Bottom	500 psi (34 bar)	Standard Knurl	Delrin Green	10-pk
XP-308x	Flangeless Fitting for 1/8" OD Tubing, Short	1/4-28 Flat-Bottom	500 psi (34 bar)	Standard Knurl	Delrin Black	10-pk
XP-315x	Flangeless Fitting for 1/8" OD Tubing	1/4-28 Flat-Bottom	500 psi (34 bar)	Standard Knurl	ETFE Natural	10-pk
XP-330x	Flangeless Fitting for 1/8" OD Tubing	1/4-28 Flat-Bottom	500 psi (34 bar)	Standard Knurl	PEEK Natural	10-pk
XP-335x	Flangeless Fitting for 1/8" OD Tubing, Short	1/4-28 Flat-Bottom	500 psi (34 bar)	Standard Knurl	PEEK Natural	10-pk
REPLACEMENT FERRULES FOR 1/8" OD TUBING						
XP-300x	Flangeless Ferrule for 1/8" OD Tubing	1/4-28 Flat-Bottom	500 psi (34 bar)	—	ETFE Yellow	10-pk
XP-300Nx	Flangeless Ferrule for 1/8" OD Tubing	1/4-28 Flat-Bottom	500 psi (34 bar)	—	ETFE Natural	10-pk
XP-340x	Flangeless Ferrule for 1/8" OD Tubing, Small Valve	1/4-28 Flat-Bottom	500 psi (34 bar)	—	ETFE Natural	10-pk
XP-312x	Lock Nut for Flangeless Nuts	1/4-28 Flat-Bottom	—	—	Delrin White	10-pk



Bio

- › Finger-tight to 19,000 psi
- › Reusable up to 200 times
- › Zero Dead Volume
- › Biocompatible
- › Limit Wear
- › Increase Product Life
- › Many IDs and Lengths Available



LEARN MORE

Learn more about MarvelX Next Generation UHPLC Fittings at www.idex-hs.com/MarvelX



NOTE

- › MarvelX tubing includes a sleeve that assists in product identification, with ID, length and part number information:

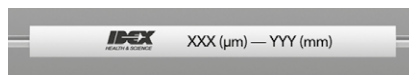

- › Minimum recommended bend-radius with MarvelX tubing is 1/4" (~6.35 mm).

MarvelX™

MarvelX™ Next Generation UHPLC Fittings

MarvelX UHPLC Connection Systems have been expertly designed for easy routing throughout your instrument, while providing consistent performance and superior re-usability. Built with convenient, removable stainless steel fittings and changeable, precision-cut flexible tubing, MarvelX can be used up to 200 times! The connection system is compatible with 10-32 coned receiving ports and is absolutely finger-tight — no tool required. MarvelX utilizes our unique next-generation patent-pending technology to auto-adjust to various port depths. This ensures zero dead volume and delivers better chromatography results with sleek, simple, and reliable functionality. In addition to our powerful Stainless Steel version, MarvelX offers a truly biocompatible option in PEEK-Lined Stainless Steel.

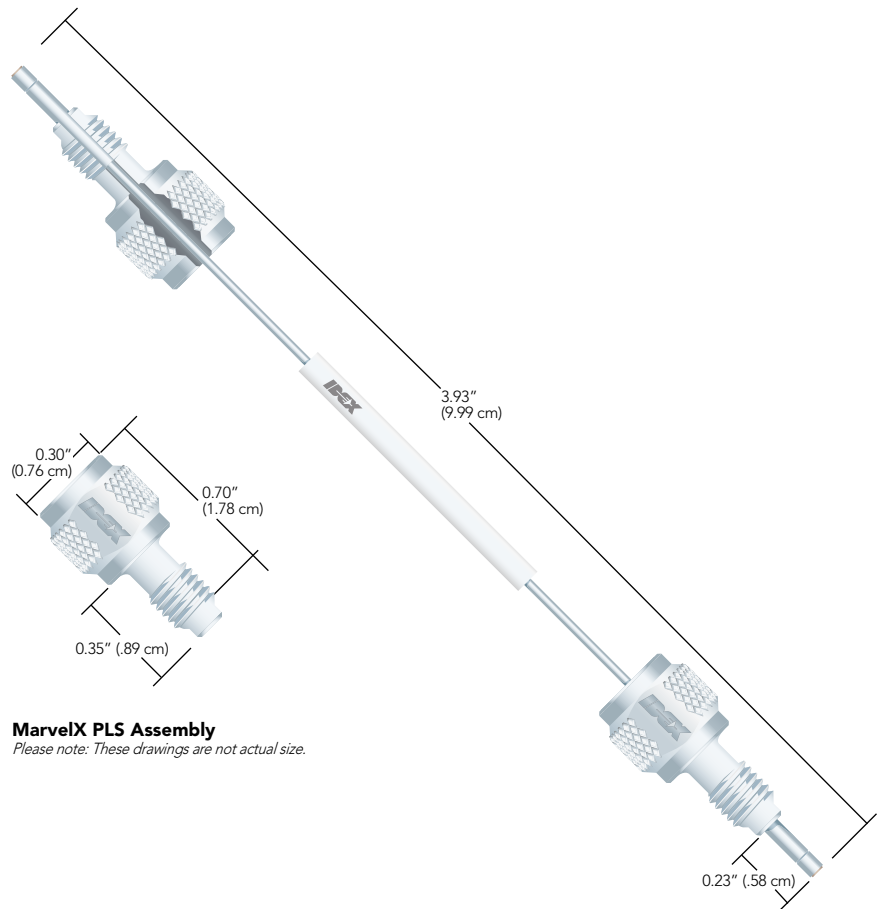

MarvelX PLS Assembly

Please note: These drawings are not actual size.



SPECIFICATIONS & DETAILS

Pressure Capability	19,000 psi (~1,310 bar) for routine use; up to 23,000 psi max over pressure for PEEK-Lined versions; up to 29,000 psi max over pressure for Stainless Steel versions.
Installation Method	Finger-tight, 1/8 – 1/4 turn after initial resistance (~2 in-lbs)
Tubing Type	1/32" OD flexible 316 Stainless Steel with 1/16" OD rigid tube ends
Fitting Type	10-32 threaded, removable 316 Stainless Steel
Wetted Materials	PEEK-Lined versions: PEEK Stainless Steel versions: PEEK and 316 Stainless Steel
Maximum Use Temperature	120 °C

NOTE: The above performance specifications apply to use with appropriately-designed receiving ports under optimal conditions, using water at up to 120 °C for the testing process. If different conditions are used, the expected pressure threshold will be different.

INSTRUCTIONS FOR TIGHTENING

- 1 Route tubing to the target port.
- 2 Slide fitting onto the tubing end via slot.
- 3 Slowly finger-tighten to first resistance; continue tightening 1/8-turn minimum, to 1/4-turn maximum.

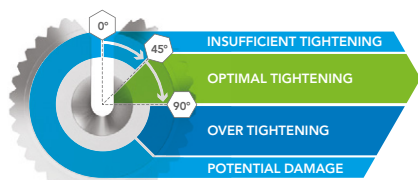

MARVELX™ UHPLC FITTINGS VS. CONVENTIONAL CONED FITTINGS

Conventional coned fittings require a ferrule in conjunction with a fitting for proper sealing. They depend on complex techniques, including tools, to improve sealing performance, which significantly increases probability of extra internal volume and poor chromatography results. The excessive force needed for tightening increases wear of expensive components and the likelihood of replacement, adding to overall costs.

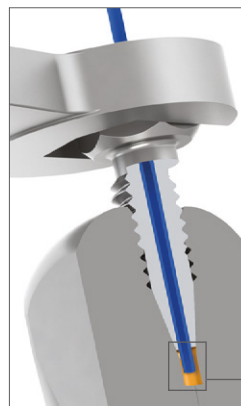

MarvelX UHPLC fittings do not depend on ferrules. They seal at the bottom of the port, without complex techniques, which significantly reduces required torque and enables many more connects and disconnects. Furthermore, they are virtually impossible to over-tighten by hand, limiting wear and increasing product life. An enhanced proprietary tip design also ensures zero dead volume (ZDV) and better chromatography results.

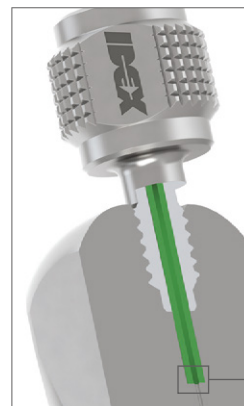

MarvelX

Length	070 MM Part No.	150 MM Part No.	250 MM Part No.	350 MM Part No.	500 MM Part No.	600 MM Part No.
PEEK-LINED STAINLESS STEEL ASSEMBLIES*						
25 µm ID	UPFP-6025070	UPFP-6025150	UPFP-6025250	UPFP-6025350	UPFP-6025500	UPFP-6025600
50 µm ID	UPFP-6050070	UPFP-6050150	UPFP-6050250	UPFP-6050350	UPFP-6050500	UPFP-6050600
75 µm ID	UPFP-6075070	UPFP-6075150	UPFP-6075250	UPFP-6075350	UPFP-6075500	UPFP-6075600
100 µm ID	UPFP-6100070	UPFP-6100150	UPFP-6100250	UPFP-6100350	UPFP-6100500	UPFP-6100600
150 µm ID	UPFP-6150070	UPFP-6150150	UPFP-6150250	UPFP-6150350	UPFP-6150500	UPFP-6150600
300 µm ID	UPFP-6300070	UPFP-6300150	UPFP-6300250	UPFP-6300350	UPFP-6300500	UPFP-6300600
STAINLESS STEEL ASSEMBLIES*						
100 µm ID	UPFS-6100070	UPFS-6100150	UPFS-6100250	UPFS-6100350	UPFS-6100500	UPFS-6100600
125 µm ID	UPFS-6125070	UPFS-6125150	UPFS-6125250	UPFS-6125350	UPFS-6125500	UPFS-6125600
254 µm ID	UPFS-6254070	UPFS-6254150	UPFS-6254250	UPFS-6254350	UPFS-6254500	UPFS-6254600
REPLACEMENT PARTS*						

Replacement Tubing To order Replacement Tubing, simply add the letter "T" to the end of any of the part numbers listed above.
Example: UPFP-6020570T is the replacement tubing for UPFP-6020570.

Replacement Fittings UPN-61032 – Includes 3 replacement fittings.

*Product availability and lead times may vary depending on the configuration. Contact Customer Service at +1 800 426 0191 or email CustomerService.hs@idexcorp.com for details.



Fittings Tools



VHP-1000
VHP Wrench
1/4 in Hex 10 in-lbs (1.13 N·m)

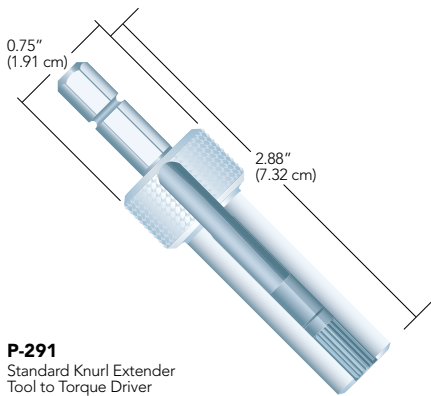

P-291
Standard Knurl Extender
Tool to Torque Driver

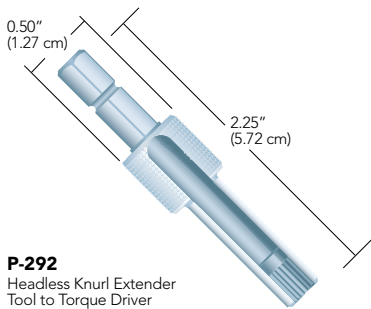

P-292
Headless Knurl Extender
Tool to Torque Driver

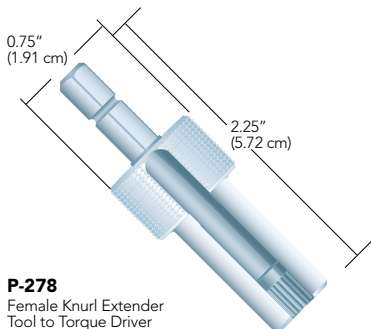

P-278
Female Knurl Extender
Tool to Torque Driver

Tightening Tools for VHP & Other Fittings

- › Configured for the optimum torque to provide assurance of a strong connection
- › Prolongs the lifetime of reusable fittings by not overtightening
- › Available for multiple fitting head styles

This new line of tightening tools is designed for the VHP fittings and can also be used with any fitting in this chapter described to have a corresponding head style to the tool listed below. There are three styles of tightening tools available for various applications. The Torque Tools (VHP-1000 and VHP-2000) are breakaway torque wrenches designed to deliver a precise amount of torque to the fitting system. These torque wrenches come calibrated according to ISO 6789:2003 ($\pm 6\%$ of setting) and have been tested extensively with the reusable VHP fittings on page 60. Choose the appropriate torque delivered and the proper head style to work with the VHP fittings, increasing the ease of use with these fittings.

The VHP-4000 Torque Driver couples with the specially designed Extender Tools listed below and provides an externally adjustable torque setting. This tool along with the appropriate Extender Tools will tighten any IDEX Health & Science knurled polymer fitting in your system. Reference the head style found in the tables at the bottom of each page for information on the proper Extender Tool to select.

Because of the small hex-head on the M4 fittings (VHP-900 and VHP-920), a custom wrench, the VHP-9000, is available in the table at the bottom of the page 51.





Extender Tools

These tools can be used to tighten most of our knurled nuts in hard to reach places. See the application note on this page for knurl size and corresponding extender tool.

For precise tightening, the extender tools listed with 1/4" hex drives are designed to adapt to any torque wrench with a female 1/4" socket, such as the VHP-4000 Torque Driver on page 51. The tools featured on this page also include the FlushNut™ wrenches, used to tighten the FlushNuts found throughout this chapter and described in detail on page 51.

APPLICATION NOTE

The drawings represent actual size of the various knurled head designs of the IDEX Health & Science nuts featured in this chapter. Select the appropriate extender tool for the knurl pattern of the nut you've selected.

FEMALE KNURL	STANDARD KNURL	HEADLESS KNURL
		
STANDARD MICRO KNURL	MICRO HEADLESS KNURL	
		



Removal Tool

Use the LT-300 Removal Tool to detach LiteTouch® and Super Flangeless™ Ferrules from tubing. Simply slide the appropriate tool blade slot between the lock ring and the ferrule body. With a slight twist, the ring will pop off, releasing the ferrule from the tubing. *Please Note: This Removal Tool will not work with the LT-135x Ferrule System.*



Wrenches

For your convenience, we offer wrenches in three standard sizes. You will need two A-304 wrenches to tighten most nuts into unions found on page 36 (for union 1593, you need one A-304 and one A-320 wrench).

The IDEX Wrench is slotted to fit over 1/16" and 1/8" OD tubing, and has 1/4" and 5/16" internal hex ends, to engage with the heads of the hex-head fittings most commonly used with IDEX Health & Science valves and the stainless steel fittings listed on page 59.

Fittings Tools

Part No.	Description	Use With Head Style	Torque Delivered	Qty.
VHP TIGHTENING TOOLS				
F-347	Extender Tool to Torque Driver	FlushNut (1/4-28)	—	ea.
N-291	Extender Tool to Torque Driver	Micro Headless	—	ea.
P-268	Extender Tool to Torque Driver	1/4" Hex	—	ea.
P-278	Extender Tool to Torque Driver	Female Nut Knurl	—	ea.
P-279	Extender Tool to Torque Driver	Micro Nut Knurl	—	ea.
P-291	Extender Tool to Torque Driver	Standard Nut Knurl	—	ea.
P-292	Extender Tool to Torque Driver	Headless Nut Knurl	—	ea.
P-1000	Standard Knurl Torque Tool	Standard Knurl	4 in-lbs (0.45 N-m)	ea.
VHP-1000	VHP Torque Tool	1/4" Hex	10 in-lbs (1.13 N-m)	ea.
VHP-2000	VHP Torque Tool	1/4" Hex	14 in-lbs (1.58 N-m)	ea.
VHP-4000	VHP Torque Driver	Extender Tool 1/4" Drive	Adjustable between 2–12 in-lbs (0.23–1.35 N-m)	ea.
VHP-9000	4 mm Wrench	4 mm Hex	—	ea.
EXTENDER TOOLS				
Part No.	Description	Material		Qty.
P-291	Extender Tool for Standard Head Nuts, with 1/4" Hex Drive	Aluminum		ea.
P-298	Extender Tool for Standard Head Nuts	Delrin®		ea.
P-299	Extender Tool for Standard Head Nuts	Aluminum		ea.
P-399	Extender Tool for Standard Head Nuts, Short	Aluminum		ea.
P-297	Extender Tool for Headless Nuts	Aluminum		ea.
P-292	Extender Tool for Headless Nuts, with 1/4" Hex Drive	Aluminum		ea.
P-277	Extender Tool for Standard Micro Nuts	Aluminum		ea.
N-290	Extender Tool for Micro Headless Nuts	Aluminum		ea.
P-278	Extender Tool for Female Nuts, with 1/4" Hex Drive	Aluminum		ea.
MISCELLANEOUS TOOLS				
A-304	Wrench, 1/4" x 5/16"	Steel		ea.
A-305	Wrench, 1/2" x 9/16"	Steel		ea.
A-320	Wrench, 3/8" x 7/16"	Steel		ea.
6810	IDEX Wrench, 1/4" x 5/16"	Steel		ea.
F-345	FlushNut Wrench for 10-32 Threaded Fittings	Steel/Plastic Handle		ea.
F-346	FlushNut Wrench for 1/4-28 Threaded Fittings	Steel/Plastic Handle		ea.
LT-300	Removal Tool for LiteTouch and Super Flangeless Ferrules	Steel/Plastic Handle		ea.
M-150	Swaging Tool for TinyTight Fittings, for 6–40 MINSTAC Port	SST		ea.



Tubing Sleeves

MicroTight® Tubing Sleeves

- › Manufactured from PEEK polymer
- › Pressure rated to 4,000 psi (276 bar)
- › Color-coded for easy inner diameter identification

IDEX Health & Science MicroTight Tubing Sleeves feature an outer diameter of 0.025" and offer a wide assortment of inner diameters to help facilitate capillary tubing connections with our MicroTight accessories. Because the sleeves are manufactured from PEEK polymer, they carry an upper temperature threshold of 125 °C.

To use these sleeves properly, choose a sleeve with an inner diameter 0.001"–0.002" (25–50 µm) larger than the outer diameter of your capillary tubing. Then, slip the sleeve over your flow path tubing, such that your tubing extends all the way through the sleeve, but not beyond the end of the sleeve. Choose the correct fitting that corresponds with your receiving port, slide it over the sleeved flow path tubing and connect as normal.



NanoTight™ Tubing Sleeves

- › Manufactured from FEP fluoropolymer
- › Pressure rated to 4,000 psi (276 bar)
- › Outer diameter of 1/16" — the most popular size used on most instrumentation

NanoTight Tubing Sleeves are manufactured using FEP fluoropolymer and precisely cut to a 1.6" length. A wide assortment of sleeves is available, ensuring the availability of a NanoTight sleeve for most applications. Many of the sleeves feature a light color tint that can help more easily identify the inner diameter for future orders. Because FEP is the base polymer for these sleeves, there is a maximum recommended continuous operating temperature of 50 °C.

Our NanoTight sleeves were designed primarily for use with the NanoTight fittings, found on page 37 and also work well with the Super Flangeless™ fittings for 1/16" OD tubing on page 39. For tubing sleeves that can be used effectively with stainless steel fittings and at higher temperatures, consider using the PEEK Tubing Sleeves, found below.

1/16" OD PEEK Tubing Sleeves

- › For connecting capillary tubing to standard 10-32 ports
- › Require the use of wrench tightened stainless steel nuts
- › Pressure rated to 6,000 psi (414 bar)



Like the NanoTight™ FEP Sleeves on the previous page, these PEEK Tubing Sleeves are designed to be used with 1/16" OD, 10-32 threaded fittings to adapt capillary tubing to standard coned ports. Made of PEEK polymer, these 1.3" long sleeves can be used up to 125 °C.

These sleeves require a wrench tightened nut to achieve proper sealing. We recommend our SealTight™ fittings on page 36. Many researchers also use a stainless steel nut and ferrule with these sleeves, such as our U-400 and U-401 (page 33).

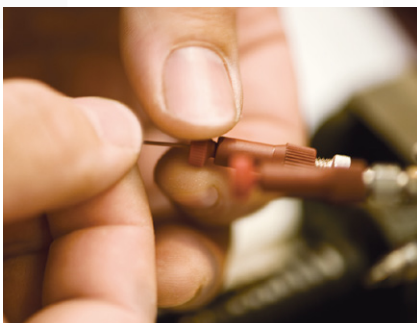

1/32" OD PEEK Tubing Sleeves

These 1.6" long 1/32" OD PEEK Tubing Sleeves can be used with any fitting designed for 1/32" OD tubing when smaller tubing must be connected. Select the appropriate sleeve from the product listing for your capillary tubing OD size. The 1/32" OD PEEK Tubing Sleeves have a maximum recommended temperature of 125 °C and have a pressure rating of 5,000 psi (345 bar).

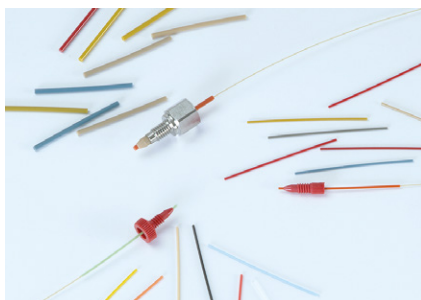

1/32" OD FEP Tubing Sleeves

These 1.6" long sleeves facilitate connecting capillary tubing into ports designed for 1/32" OD tubing. Please refer to the product listing below to select the appropriate sleeve for your capillary OD size. These sleeves can be used at up to 50 °C and have a pressure rating of 1,750 psi (121 bar).

Clockwise, starting at top:

- › 1/16" OD PEEK Tubing Sleeves, use with U-400 and U-401 (not shown)
- › 1/32" OD FEP Tubing Sleeves, shown with F-126Sx Fitting
- › Fittings and tubing only shown to highlight how sleeves are designed to be used; they are not included with the sleeves



APPLICATION NOTE

Why use Sleeves?

Because most capillary tubing connections are made into coned receiving ports, where the port is not designed to be used with capillary tubing directly, special care must be used to ensure a good connection. While custom ferrules can help make these connections, they only offer a fixed-length nose — and because most tubing pockets will vary slightly in length, this can lead to leaking or dead volume.

To help save overall expense while maintaining a concentric connection with minimal dead volume, IDEX Health & Science recommends the use of sleeves. Because sleeves are not permanently attached to a ferrule, they can easily adapt to varying tubing pocket depths. Additionally, because they are manufactured using extruded polymer tubing, you are assured of the concentricity of the resultant connection.

Tubing Sleeves (Cont.)



RELATED PRODUCTS

Use 1/32" OD PEEK or FEP Sleeves to connect capillary tubing with the following:

- › The F-113 Ferrule and Two-Piece Fingertight Fittings for 10-32 ports (page 35).
- › The F-112 and P-416BLK MicroTight® Fittings (page 34) — 1/32" OD PEEK Tubing Sleeves only.
- › The 1/32" OD MicroTight Fittings on page 34.
- › The RheFlex M4 Fitting (page 61) for MX Module applications; the M-645 Valco®-Compatible Fitting (page 33) for Valco Nanovolume® valve applications.

Tubing Sleeves

Part No.	ID	For Tubing OD Size	Color	Qty.
MICROTIGHT PEEK TUBING SLEEVES AND KITS, 0.025" OD				
F-180	125 µm (0.005")	70–110 µm	Red	ea.
F-181	180 µm (0.007")	125–165 µm	Yellow	ea.
F-182	230 µm (0.009")	175–215 µm	Natural	ea.
F-183	280 µm (0.011")	225–265 µm	Blue	ea.
F-184	330 µm (0.013")	275–315 µm	Orange	ea.
F-185	395 µm (0.0155")	340–380 µm	Green	ea.
F-186	455 µm (0.018")	400–440 µm	Black	ea.
F-187	535 µm (0.021")	480–520 µm	Natural	ea.
F-188	152 µm (0.006")	95–135 µm	Purple	ea.
1328	MicroTight Tubing Sleeve Kit, contains (6) each of the sleeve sizes listed above	—	—	ea.
1356	MicroTight Connector Kit, contains: a 10-pack of each MicroTight Tubing Sleeve (F-180–F-187); (2) P-770 MicroTight Adapters; and (2) MicroTight P-720 Unions	—	—	ea.
NANOTIGHT FEP TUBING SLEEVES, 1/16" OD				
F-237	125 µm (0.005")	70–110 µm	Red	ea.
F-238	180 µm (0.007")	125–165 µm	Yellow	ea.
F-239	215 µm (0.0085")	160–200 µm	Natural	ea.
F-240	280 µm (0.011")	225–265 µm	Blue	ea.
F-241	330 µm (0.013")	275–315 µm	Orange	ea.
F-242	395 µm (0.0155")	340–380 µm	Green	ea.
F-243	455 µm (0.018")	400–440 µm	Black	ea.
F-244	535 µm (0.021")	480–520 µm	Natural	ea.
F-245	610 µm (0.024")	555–595 µm	Red	ea.
F-246	685 µm (0.027")	630–670 µm	Yellow	ea.
F-247	840 µm (0.033")	785–825 µm	Green	ea.
F-252	1.07 mm (0.042")	1 mm	Purple	ea.
PEEK TUBING SLEEVES FOR 1/16" OD FITTINGS				
F-225	125 µm (0.005")	70–110 µm	Red	ea.
F-226	180 µm (0.007")	125–165 µm	Yellow	ea.
F-227	230 µm (0.009")	175–215 µm	Yellow	ea.
F-228	250 µm (0.011")	225–265 µm	Blue	ea.
F-229	330 µm (0.013")	275–315 µm	Natural	ea.
F-230	405 µm (0.016")	350–390 µm	Orange	ea.
F-231	560 µm (0.022")	505–545 µm	Natural	ea.
F-232	785 µm (0.031")	730–770 µm	Natural	ea.
F-233	865 µm (0.034")	785–825 µm	Blue	ea.
F-234	685 µm (0.027")	630–670 µm	Yellow	ea.
PEEK TUBING SLEEVES FOR 1/32" OD FITTINGS				
F-381	180 µm (0.007")	125–165 µm	Yellow	ea.
F-382	205 µm (0.008")	150–190 µm	Natural	ea.
F-384	255 µm (0.010")	200–240 µm	Blue	ea.
F-385	380 µm (0.015")	325–365 µm	Natural	ea.
F-386	510 µm (0.020")	455–495 µm	Orange	ea.
F-387	250 µm (0.011")	225–265 µm	Red	ea.
F-388	330 µm (0.013")	275–315 µm	Black	ea.
FEP TUBING SLEEVES FOR 1/32" OD FITTINGS				
F-374	280 µm (0.011")	225–265 µm	Blue	ea.
F-375	330 µm (0.013")	275–315 µm	Orange	ea.
F-376	395 µm (0.0155")	340–380 µm	Green	ea.



Plugs & Caps

- › Seal 6-32, 6-40, 10-32, 1/4-28, M6, or 5/16-24 threaded ports or fittings

Use our plugs to close off unused ports in valves and multi-port connectors. Our color-coded 10-32 threaded plugs are perfect for identifying stored columns that have different packing materials, or in which different mobile phases have been utilized. Cap off tubing with one of the PEEK or ETFE caps presented on this page and the appropriate fittings from this chapter.

To help determine which plug or cap is best suited for your application, please visit www.idex-hs.com for detailed chemical compatibility data.

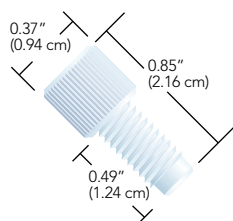

P-316
PFA Plug
for 1/4-28 flat-bottom ports

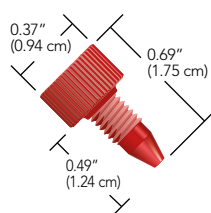

U-467R
Delrin® Column Plug
for 10-32 coned ports

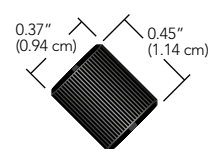

P-755
ETFE Cap
for 1/4-28 flat-bottom fittings

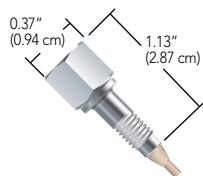

VHP-600
VHP Plug
for 10-32 coned ports

Part No.	Description	Head Style	Material	Qty.
PLUGS				
P-120	Plug for 1/4-28 Coned Ports for 1/8" OD Tubing	Standard Knurl	PCTFE Natural	ea.
P-123	Plug for 1/4-28 Flat-Bottom Ports	5/16" Hex	ETFE Natural	ea.
P-309	Plug for 1/4-28 Flat-Bottom Ports	Standard Knurl	Delrin Black	ea.
P-311	Plug for 1/4-28 Flat-Bottom Ports	Standard Knurl	ETFE Natural	ea.
P-314	Plug for M6 Flat-Bottom Ports	Standard Knurl	ETFE Black	ea.
P-316	Plug for 1/4-28 Flat-Bottom Ports	Standard Knurl	PFA Natural	ea.
P-321	Plug for 1/4-28 Flat-Bottom Ports, FlushNut™	FlushNut	PEEK Natural	ea.
P-520	Plug for 10-32 Coned Ports	5/16" Hex	SST	ea.
P-550	Plug for 10-32 Coned Ports, Extra Long	Standard Knurl	PEEK Natural	ea.
P-551	Plug for 10-32 Coned Ports	Standard Knurl	PEEK Natural	ea.
P-555	Plug for 6-32 Coned Ports	Standard Micro Knurl	PEEK Natural	ea.
P-556	Plug for 5/16-24 Flat-Bottom Ports	Standard Knurl	PEEK Natural	ea.
P-558	Plug for 6-40 Flat-Bottom Ports	Micro Headless Knurl	PEEK Green	ea.
P-849	Plug for 10-32 Flat-Bottom Ports	Standard Knurl	Delrin Black	ea.
U-467R	Plug for 10-32 Coned Ports	Standard Knurl	Delrin Red	ea.
VHP-600	VHP Plug for 10-32 Coned Ports	3/8" Hex	PK-SST	ea.
CAPS				
P-754	Cap for 10-32 Coned Ports	Standard Knurl	ETFE Yellow	ea.
P-755	Cap for 1/4-28 Flat-Bottom Ports	Standard Knurl	ETFE Black	ea.
P-756	Cap for M6 Flat-Bottom Ports	Standard Knurl	ETFE Blue	ea.

Large Bore Fittings

- › 5/16-24 or 1/2-20 threads
- › For use with 1/16", 1/8", 3/16", 1/4", 5/16", 3.0 mm, or 4.0 mm OD tubing

NOTE

Each of the Large Bore Fittings shown on this page comes in a convenient 10-pack and is packaged with the most popularly chosen Ferrule option. The Fittings can be ordered separately by removing the preceding letter "X" from the part number. Additionally, to connect metric-sized tubing with outer diameters less than 4.0 mm to 5/16-24 threaded ports, reference the chart on page 43 to choose the correct nut/ferrule combination.

RELATED PRODUCTS

	Page
MORE LARGE BORE PRODUCTS	
5/16-24 Coned Fittings	41
Barbed Adapters	90
Threaded Adapters	63
Plugs	55, 112
Y Connector	90
ETFE Tubing	27
FEP, PFA Tubing	26, 24
Tubing Cutter	28
Pressure Relief Valve	148
Solvent Inlet Filters	102
Bottle Caps	55
Semi-Prep Inline Filters	107

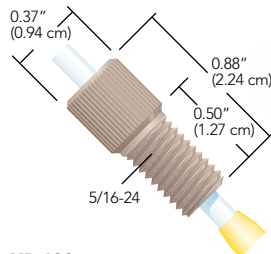

XP-130x
PEEK Nut, for 1/8" OD tubing shown with P-300 Flangeless Ferrule (page 43)

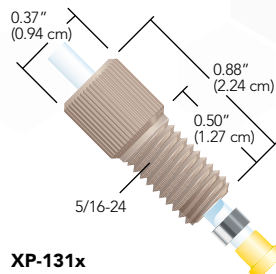

XP-131x
PEEK Nut, for 1/8" OD tubing shown with P-359 Super Flangeless™ Ferrule (included and found on page 41)

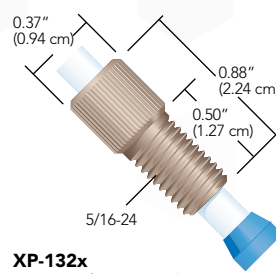

XP-132x
PEEK Nut, for 3/16" and 4.0 mm OD tubing shown with P-133 Flangeless Ferrule (included and found on this page)

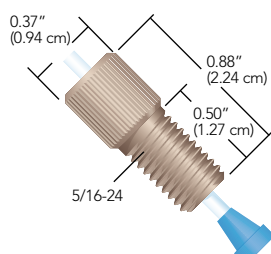

XP-136x
PEEK Nut, for 1/16" OD tubing shown with P-200 Flangeless Ferrule (included and found on page 43)

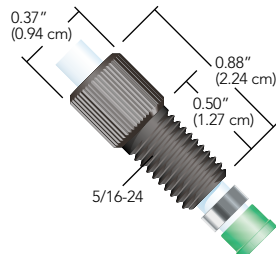

XP-137x
PEEK Nut, for 3/16" OD tubing shown with P-140 Super Flangeless Ferrule (included and found on page 56)

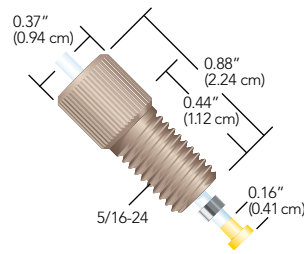

XP-141x
PEEK Nut, for 1/16" OD tubing shown with P-259 Super Flangeless Ferrule (included and found on page 41)

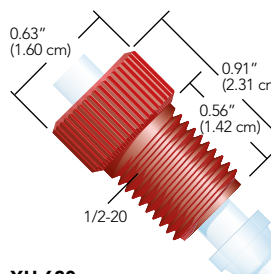

XU-620x
PEEK Nut, for 1/4" OD tubing shown with inverted U-650 Flangeless Ferrule for coned ports (included and found on this page)

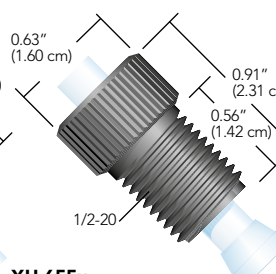

XU-655x
PEEK Nut, for 1/4" OD tubing shown with U-650 Flangeless Ferrule (included and found on this page)

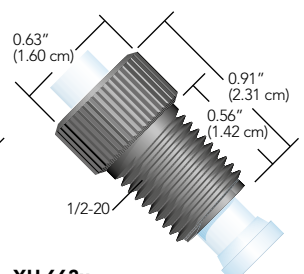

XU-662x
PEEK Nut, for 1/4" OD tubing shown with U-660 Flangeless Ferrule (included and found on this page)

Part No.	Description	Port	Pressure Rating	Head Style	Material (Nut/Washer)	Qty.
LARGE BORE FITTINGS						
XP-130x	Flangeless Fitting for 1/8" OD tubing	5/16-24 Flat-Bottom	500 psi (34 bar)	Standard Knurl	PEEK Natural/ETFE Yellow	10-pk
XP-131x	Super Flangeless Fitting for 1/8" OD tubing	5/16-24 Flat-Bottom	1,000 psi (69 bar)	Standard Knurl	PEEK Natural/ETFE Yellow/SST	10-pk
XP-132x	Flangeless Fitting for 3/16" OD tubing	5/16-24 Flat-Bottom	500 psi (34 bar)	Standard Knurl	PEEK Natural/ETFE Blue	10-pk
XP-136x	Flangeless Fitting for 1/16" OD tubing	5/16-24 Flat-Bottom	2,000 psi (138 bar)	Standard Knurl	PEEK Natural/ETFE Blue	10-pk
XP-137x	Super Flangeless Fitting for 3/16" OD tubing	5/16-24 Flat-Bottom	500 psi (34 bar)	Standard Knurl	PEEK Black/ETFE Green/SST	10-pk
XP-141x	Super Flangeless Fitting for 1/16" OD tubing	5/16-24 Flat-Bottom	1,350 psi (93 bar)	Standard Knurl	PEEK Natural/ETFE Yellow/SST	10-pk
XU-620x	Flangeless Fitting for 1/4" OD tubing	1/2-20 Coned	250 psi (17 bar)	Large Knurl	PEEK Red/ETFE Natural	10-pk
XU-655x	Flangeless Fitting for 1/4" OD tubing	1/2-20 Flat-Bottom	250 psi (17 bar)	Large Knurl	PEEK Black/ETFE Natural	10-pk
XU-662x	Flangeless Fitting for 5/16" OD tubing	1/2-20 Flat-Bottom	250 psi (17 bar)	Large Knurl	PEEK Black/ETFE Natural	10-pk
REPLACEMENT FERRULES						
P-133x	Flangeless Ferrule for 3/16" OD tubing	5/16-24 Flat-Bottom	500 psi (34 bar)	—	ETFE Blue	10-pk
P-133Nx	Flangeless Ferrule for 3/16" OD tubing	5/16-24 Flat-Bottom	500 psi (34 bar)	—	ETFE Natural	10-pk
P-140x	Super Flangeless Ferrule for 3/16" OD tubing	5/16-24 Flat-Bottom	500 psi (34 bar)	—	ETFE Green	10-pk
U-650x	Flangeless Ferrule for 1/4" OD tubing	1/2-20 Flat-Bottom	250 psi (17 bar)	—	ETFE Natural	10-pk
U-660x	Flangeless Ferrule for 5/16" OD tubing	1/2-20 Flat-Bottom	250 psi (17 bar)	—	ETFE Natural	10-pk



VHP Micro Fittings

Micro Fittings are specifically designed for use with microferrules. They are manufactured from a proprietary PEEK blend (PK) which allow them to be used at higher temperatures (up to 200° C) and higher pressures ideal for UHPLC applications.

VHP MicroFerrules and Fittings are made from a proprietary high performance PEEK polymer blend, a material which is unique in its ability to enable the use of capillary tubing in UHPLC environments. The new high pressure MicroFerrules are available for use with 1/32" or 360 µm OD tubing, and they are incorporated into several of our VHP products for capillary tubing.

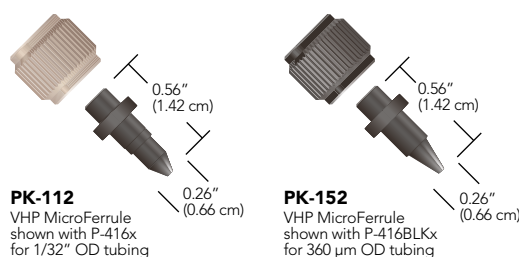

PK-112
VHP MicroFerrule
shown with P-416x
for 1/32" OD tubing

PK-152
VHP MicroFerrule
shown with P-416BLKx
for 360 µm OD tubing



APPLICATION NOTE

Caution: While the proprietary blend of the PK fittings will allow a fitting to attain a higher pressure and minimal cold flow properties relative to pure PEEK, some fittings molded of PK are known to be conductive. Use caution when employing PK fittings in high voltage applications.



NOTE

MicroTight fittings and MicroFerrules

While the MicroTight Female Nuts may be used with any of the separate MicroFerrules, the MicroFerrules themselves are port-specific and are thus not interchangeable. Additionally, the one-piece MicroTight fittings are also port-specific and should not be exchanged.

Part No.	Description	Port	Pressure Rating	Required Torque	Head Style	Material	Qty.
PK MICRO FERRULES AND FEMALE NUTS							
P-416	Female Nut for Microferrule	5/16-24 Coned	15,000 psi (1,035 bar)	4.0 in-lbs (0.45 N-m)	Female Knurl	PEEK, Natural	ea.
P-416BLK	Female Nut for Microferrule	5/16-24 Coned	15,000 psi (1,035 bar)	4.0 in-lbs (0.45 N-m)	Female Knurl	PEEK, Black	ea.
PK-112	VHP MicroFerrule for 1/32" OD Tubing	5/16-24 Coned	15,000 psi (1,035 bar)	—	—	PK	ea.
PK-152	VHP MicroFerrule for 360 µm OD Tubing	5/16-24 Coned	15,000 psi (1,035 bar)	—	—	PK	ea.



VHP PK Fittings

RELATED PRODUCTS

- Find unions, tees and crosses for VHP applications on page 75, and 74.

Ultra High Performance fittings are manufactured from a proprietary PEEK blend (PK) which allow them to be used at higher temperatures (up to 200 °C) and higher pressures.

The VHP PK One-Piece fittings are available for 10-32 coned, 6-32 coned, or M4 coned ports, and Two-Piece fittings are available to connect either 1/16" or 1/32" OD tubing into 10-32 coned ports in multiple styles.

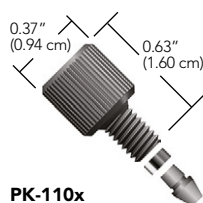

PK-110x
10-32 PK Fitting
shown with PK-100x for
1/16" OD tubing

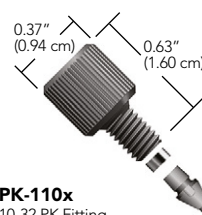

PK-110x
10-32 PK Fitting
shown with PK-132x for
1/32" OD tubing

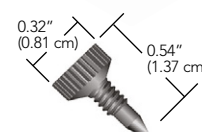

PK-126x
6-32 PK MicroTight® Fitting
for 1/32" OD tubing

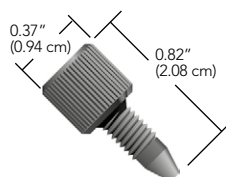

PK-120BLKx
10-32 PK Fitting
for 1/16" OD tubing

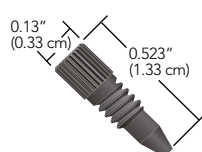

PK-126Hx
6-32 PK MicroTight® Fitting
for 1/32" OD tubing

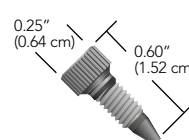

UH-904x
M4, 1/32" Fitting
for IDEX Health & Science
MX valves

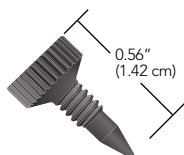

PK-124x
6-32 PK MicroTight® Fitting
for 1/32" OD tubing

Part No.	Description	Port	Pressure Rating	Required Torque	Head Style	Material	Qty.
PK VHP ONE-PIECE FITTINGS							
PK-120BLKx	PK One-Piece Fitting for 1/16" OD Tubing	10-32 Coned	12,000 psi (827 bar)	8.0 in-lbs (0.90 N-m)	Standard Knurl	PK	10-pk
PK-126Hx	PK One-Piece Headless Fitting for 1/32" OD Tubing	6-32 Coned	15,000 psi (1,035 bar)	3.0 in-lbs (0.34 N-m)	Headless Micro Knurl	PK	10-pk
PK-126x	PK One-Piece Fitting for 1/32" OD Tubing	6-32 Coned	15,000 psi (1,035 bar)	3.0 in-lbs (0.34 N-m)	Standard Micro Knurl	PK	10-pk
UH-904x	PK One-Piece Fitting for 1/32" OD Tubing	M4 Coned	15,000 psi (1,035 bar)	4.0 in-lbs (0.45 N-m)	Headless Knurl	PK	10-pk
PK VHP FITTINGS (LITETOUCH® STYLE, NUTS AND FERRULES SOLD SEPARATELY)							
PK-100x	PK Ferrule for 1/16" OD Tubing	10-32 Coned	16,500 psi (1,140 bar)	—	—	PK	10-pk
PK-110x	PK Nut for 1/16" OD Tubing	10-32 Coned	16,500 psi (1,140 bar)	8.0 in-lbs (0.90 N-m)	Standard Knurl	PK	10-pk
PK-132x	PK Ferrule for 1/32" OD Tubing	10-32 Coned	16,500 psi (1,140 bar)	—	—	PK	10-pk

Stainless Steel VHP Fittings

- › Pressure rated to 30,000 psi (2,070 bar)
- › Double compression ferrule design
- › Available with 10-32 threads for 1/16" OD tubing and M4 threads for 1/32" OD tubing

The all Stainless-Steel VHP Fittings include a unique ferrule system with two compression points to provide twice the grip of a standard ferrule. This design also allows the bite on the tubing to be less concentrated and does not restrict the inner diameter, as discussed in the Application Note. The ferrules for 1/16" OD tubing and 10-32 coned ports are two pieces, while the grooved ferrule for 1/32" OD tubing and M4 coned ports is a one-piece design for easier handling, but it will act as two pieces with double compression on the tubing as it is tightened down.



APPLICATION NOTE

In order to seal up to the stated pressure rating, the VHP-200-01 ferrule requires 20 in-lbs (2.25 N·m) of torque. Similar ferrules on the market require tightening torque of at least 30 in-lbs (3.3 N·m), which can result in a restricted tubing passage, as shown in the picture below. This restriction can increase turbulence and add a 'throttling' effect to the fluid pathway, resulting in mixing and other potential chromatographic problems.

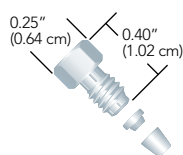

VHP-200x
VHP 10-32 Fitting
for 1/16" OD tubing

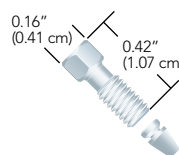

VHP-700x
VHP 6-40 Fitting
for 1/32" OD tubing

IDEX Health & Science
VHP-200

Conventional Two
Piece Ferrule Design

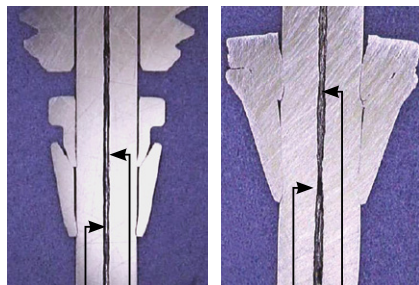

Uniform
Tubing Passage

Constricted
Tubing Passage

Part No.	Description	Port	Pressure Rating	Required Torque	Head Style	Material	Qty.
STAINLESS STEEL VHP FITTINGS (INCLUDES NUT AND FERRULE)							
VHP-200x	VHP Fitting for 1/16" OD	10-32 Coned	30,000 psi (2,070 bar)	20 in-lbs (2.25 N·m)	1/4" Hex	SST	10-pk
VHP-700x	VHP Fitting for 1/32" OD	6-40 Coned	30,000 psi (2,070 bar)	20 in-lbs (2.25 N·m)	4 mm Hex	SST	10-pk
STAINLESS STEEL VHP FERRULES							
VHP-200-01x	VHP Ferrule for 1/16" OD	10-32 Coned	30,000 psi (2,070 bar)	20 in-lbs (2.25 N·m)	—	SST	10-pk



Reusable VHP Fittings

- › Pressure rated up to 25,000 psi (1,720 bar)
- › Patented innovative design
- › Capable of up to ten repeat assembly cycles with no impact on pressure holding ability or carry-over
- › Available in 10-32 threads for 1/16" OD tubing and M4 threads for 1/32" OD tubing
- › Materials of construction: stainless steel and proprietary PEEK polymer blend (PK)
- › Quick component replacement, minimal downtime



RELATED PRODUCTS

- › Find tightening tools on page 50 designed to deliver the torque necessary for these fittings.

IDEX Health & Science introduces an innovative line of Very High Pressure (VHP) fittings, designed to withstand extreme pressures. This patented line of ground-breaking fitting systems is perfect for use within the increasingly demanding requirements of today's high performance analytical systems.

The Reusable VHP fittings can be reused when following the tightening torque specification listed below. With a polymer front ferrule, there is no damage to the tubing or receiving port, also increasing the life of these components.

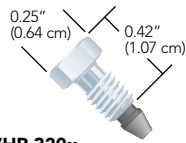

VHP-320x
10-32 VHP Fitting
for 1/16" OD tubing

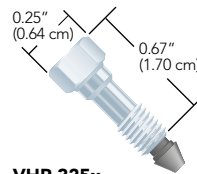

VHP-325x
10-32 VHP Fitting, Long
for 1/16" OD tubing

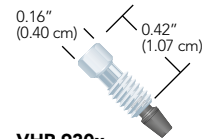

VHP-920x
M4 VHP Fitting
for 1/32" OD tubing



VHP-3200x
10-32 VHP Fitting
for 1/16" OD tubing

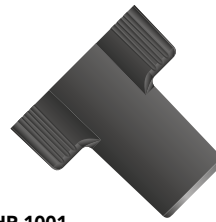

VHP-1001
VHP Fingertight
1/4" Hex Tool

Part No.	Description	Port	Pressure Rating	Required Torque	Head Style	Material	Qty.
REUSABLE VHP FITTINGS							
VHP-320x	VHP Fitting for 1/16" OD	10-32 Coned	25,000 psi (1,720 bar)	10 in-lbs (1.10 N-m)	1/4" Hex	SST/PK	10-pk
VHP-325x	VHP Fitting for 1/16" OD, Long	10-32 Coned	25,000 psi (1,720 bar)	10 in-lbs (1.10 N-m)	1/4" Hex	SST/PK	10-pk
VHP-920x	VHP Fitting for 1/32" OD	M4 Coned	25,000 psi (1,720 bar)	8 in-lbs (0.90 N-m)	4 mm Hex	SST/PK	10-pk
VHP-3200x	VHP Fitting for 1/16" OD	10-32 Coned	11,000 psi (760 bar)	3.5 in-lbs (0.40 N-m)	1/2" Knurl	SST/PK	10-pk
VHP-1001	VHP Fingertight 1/4" Hex Tool	—	—	—	—	PPS	ea.

Assorted Fittings Kits

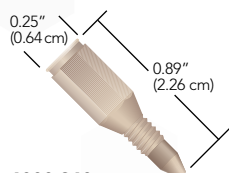
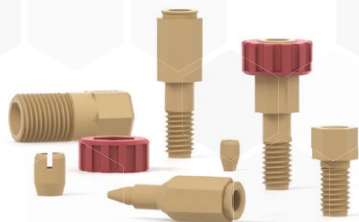

6000-360
M4 Fitting
M4 threads
for 1/32" OD tubing

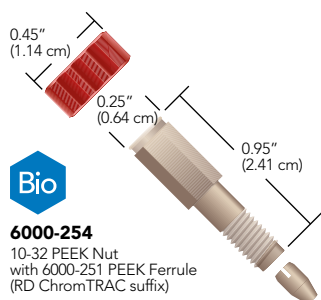

6000-254
10-32 PEEK Nut
with 6000-251 PEEK Ferrule
(RD ChromTRAC suffix)

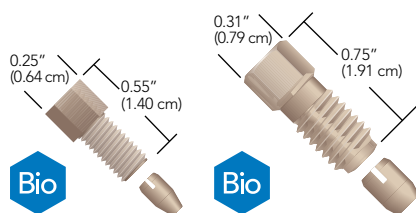

6000-255
10-32 PEEK Nut
with 6000-251 PEEK Ferrule

6000-078
5/16-24 PEEK Nut
with 6000-079 PEEK Ferrule

RheFlex® M4 Fittings

- › Incorporates M4 coned threads for 1/32" OD tubing
- › Pressure rated to 5,000 psi (345 bar)

Our RheFlex M4 Fitting is designed to connect 1/32" OD tubing in MX Series II™ valves (see Actuated Valves, starting on page 119). This PEEK fitting has a one piece design, which eliminates the need for a separate nut and ferrule. The M4 Fitting design provides dependable zero dead volume connections for micro and nano applications. Due to the unique RheFlex gripping design, the M4 Fitting will hold to 5,000 psi (345 bar) on PEEK or with a PEEK tubing sleeve on fused silica tubing. A PEEK M4 Plug is also available.

Use ChromTRAC™ knobs with the RheFlex M4 Fitting for fingertight convenience and to color-code connections.

Two-Piece RheFlex Fingertight Fittings

The RheFlex Precision Two-Piece PEEK Fittings sets provide inert, biocompatible connections for instrumentation. These fittings have a reliable, time-tested design. Each 1/16" fittings set contains a 10-32 threaded nut and a specially-designed PEEK ferrule. Three lengths of the 1/16" nut are available: Standard, Short, and Extra Long. RheFlex Fingertight Fittings are rated for use up to 7,000 psi (483 bar). Also offered in this product line is the 6000-078 fitting, designed to connect 1/8" OD tubing into our manual preparative-scale injection valves. (See page 115 for more information on these valves.) *View the online product bulletin at: www.idex-hs.com.*

ChromTRAC™

- › Brightly colored knobs to easily track inlets and outlets of valves, columns, and detectors

All ChromTRAC-compatible RheFlex fittings offer the ChromTRAC knob option. Specify the ChromTRAC two letter suffix for the color choice when ordering. Please see the ChromTRAC Suffix Codes table below. For example, to order red ChromTRAC knobs with the RheFlex One-Piece Fitting on this page, specify 6000-282RD. No suffix indicates black knobs. *View the online product bulletin for RheFlex fittings at: www.idex-hs.com.*

ChromTRAC Suffix Codes

CODE	COLOR	CODE	COLOR
BL	Blue	WH	White
GN	Green	YL	Yellow
GY	Gray	MC	Multi-color (two each of blue, green, gray, red, and yellow)
RD	Red		

Add these letter suffixes to the end of the seven-digit part numbers of the 10-32 and M4 threaded RheFlex Fittings listed below.

RELATED PRODUCTS

- › For PEEK tubing sleeves that can be used with these M4 RheFlex fittings, see page 52.
- › For reusable fittings that both work in UHPLC applications and can help ensure the tubing is fully inserted into the receiving port, see page 60.

Part No.	Description	Port	Pressure Rating	Head Style	Material	Qty.
RHEFLEX ONE-PIECE FITTINGS						
6000-360	RheFlex Fitting for 1/32" OD Tubing	M4 Coned	5,000 (345 bar)	1/4" Hex	PEEK, Natural	10-pk
RHEFLEX TWO-PIECE FITTINGS (INCLUDES FERRULES)						
6000-078	RheFlex Fitting for 1/8" OD Tubing	5/16-24 Coned	5,000 psi (345 bar)	5/16" Hex	PEEK, Natural	ea.
6000-254	RheFlex Fitting for 1/16" OD Tubing	10-32 Coned	7,000 psi (483 bar)	ChromTRAC knob	PEEK, Natural	10-pk
6000-255	RheFlex Fitting for 1/16" OD Tubing, Short	10-32 Coned	7,000 psi (483 bar)	1/4" Hex	PEEK, Natural	10-pk
REPLACEMENT FERRULES						
6000-079	RheFlex Ferrule for 1/8" OD Tubing	5/16-24 Coned	7,000 psi (483 bar)	ChromTRAC knob	PEEK, Natural	5-pk
6000-251	RheFlex Ferrule for 1/16" OD Tubing	10-32 Coned	7,000 psi (483 bar)	ChromTRAC knob	PEEK, Natural	10-pk

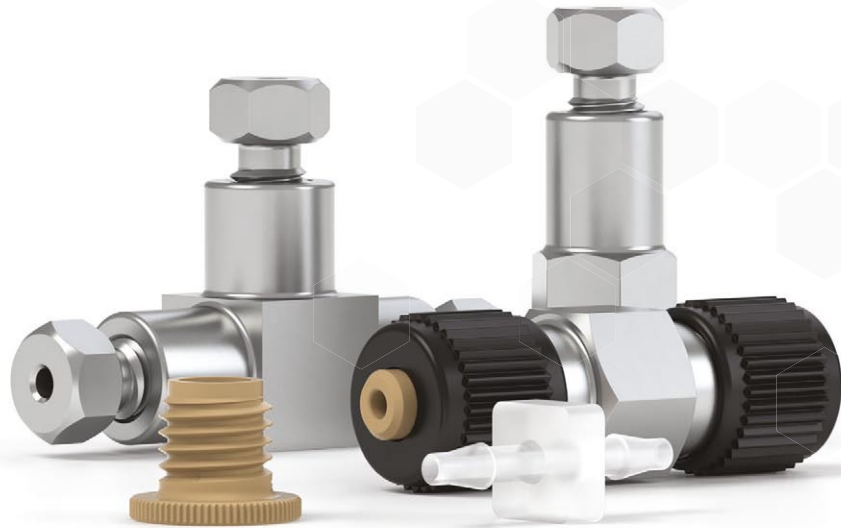

CONNECTORS

Connectors are designed to securely join tubing together or to facilitate the joining of tubing to other fluid pathway components. We offer multiport connectors with different thread and port configurations to meet your system requirements and connection needs. Some of our connectors feature a True ZDV (Zero Dead Volume) internal configuration that helps minimize the formation of dead volume in your fluidic pathway. Our versatile adapters help bring two connectors with different configurations together. Connectors are manufactured from 316 stainless steel or from inert polymers to ensure chemical compatibility with the fluid passing through. Peristaltic tube connectors are ideal for making connections with soft-walled, peristaltic tubing. Our extensive line of connectors includes tees, crosses, Luer Adapters, barbed and threaded adapters, and a variety of other options.

- | | | | |
|-----------|--|-----------|---|
| 63 | THREADED ADAPTERS | 79 | ACCESSORIES |
| 67 | HIGH PRESSURE
MULTIPORT
CONNECTORS | 80 | NANOPORT
ASSEMBLIES |
| 72 | ULTRA HIGH
PRESSURE MULTIPORT
CONNECTORS | 81 | LOW PRESSURE
MULTIPORT
CONNECTORS |
| 77 | MICROTIGHT®
ADAPTERS | 90 | LUER ADAPTERS |
| | | 91 | PERISTALTIC TUBE
CONNECTORS |



Threaded Adapters

- ▶ Threaded adapters in a variety of configurations
- ▶ English, Metric, and NPT threaded adapters offered
- ▶ Bring together connectors with different threads
- ▶ Manufactured from inert polymers — PEEK, PCTFE, ETFE, and PTFE

Two of the many challenges researchers face regularly, are trying to use one style of fitting for all connections, or trying to join two different sizes of tubing. To assist in overcoming these challenges we have engineered one of the most extensive threaded adapter lines available.

Threaded Adapters come in a wide variety of configurations to meet your system requirements. They are designed to effectively bring together connectors with different threads. We offer them in English, Metric, and NPT versions. Manufactured from inert polymers and stainless steel they deliver excellent chemical resistance.



English Threaded Adapters

Our versatile English Threaded Adapters are used specifically to securely attach connectors with different threads. We designed these adapters to work with English to English threaded geometries. Manufactured from Stainless Steel, PEEK, or Tefzel™ (ETFE), they deliver excellent solvent resistance.

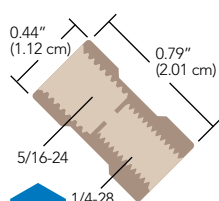

P-135
0.080" (2.05 mm) thru-hole

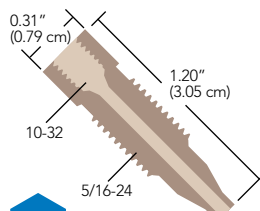

6000-076
0.066" (1.70 mm) thru-hole

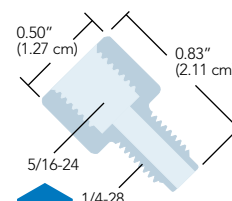

P-681
0.125" (3.20 mm) thru-hole

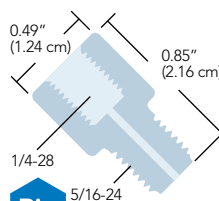

P-718
0.040" (1.00 mm) thru-hole

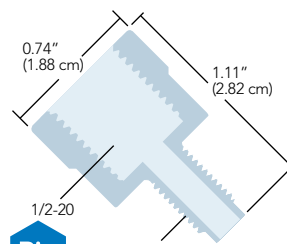

P-684
0.130" (3.30 mm) thru-hole



P-627
0.020" (0.50 mm) thru-hole
Includes (1) F-300 for 1/16" OD tubing

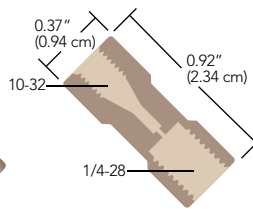

Threaded Adapters (Cont.)

NOTE

- When using an adapter with male (external) threads, we recommend you first attach the adapter body into the receiving port, and then connect your tubing and fitting into the head of the adapter body.

RELATED PRODUCTS

- Use the 6000-076 Adapter to connect 1/16" OD tubing to the Preparative-Scale Injector Valve (page 66).
- You may not need an adapter to connect 1/16" OD tubing into your flat-bottom port. A less expensive alternative is to use a Flangeless Nut and Ferrule starting on page 45 or a Super Flangeless™ Nut and Ferrule starting on page 39.

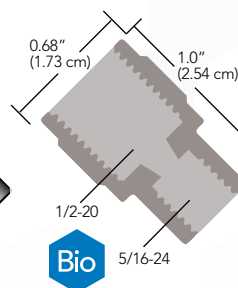
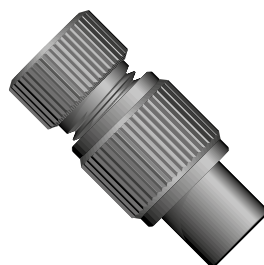

U-659

Tapered thru-hole
Includes (1) U-650/U-655
for 1/4" OD tubing

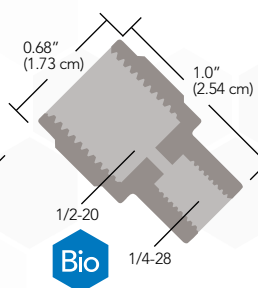

U-665

0.063" (1.60 mm) thru-hole
Includes (1) U-650/U-655
for 1/4" OD tubing



Bio

P-652

0.030" (0.75 mm) thru-hole
(Note the new knurled design)

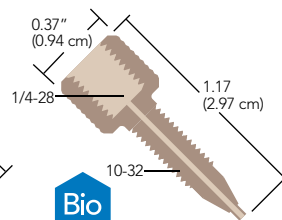
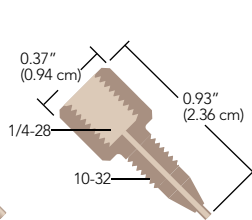

Bio

P-654

Extra Long, 0.030"
(0.76 mm) thru-hole

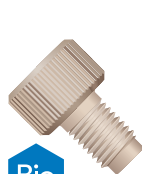

Bio

P-669-01

0.040" (1.00 mm) thru-hole

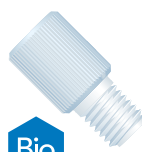
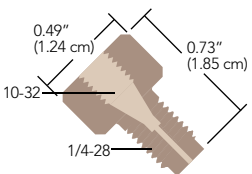

Bio

P-671

0.040" (1.00 mm) thru-hole

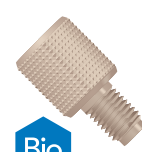
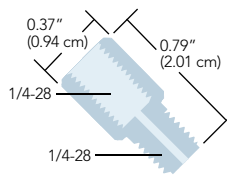

Bio

P-672

0.050" (1.25 mm) thru-hole

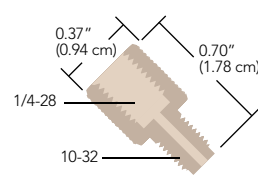

APPLICATION NOTE

Here are application ideas using two of our popular adapters:

- Many injection valves used in HPLC systems have 10-32 coned ports designed to accept 1/16" OD tubing. However, this may be a problem if large injection volumes are required (in excess of 10 mL). The most popular loops for large volume samples are made from 1/8" OD tubing, making it impossible to connect these larger volume loops to your injection valve. The solution: use our P-654 Adapter and the appropriate fittings for your sample loop. This set-up allows connection of 1/8" OD sample loop leads to your injection valve.
- Another potential application is connecting tubing to low-pressure solenoid valves with 1/4-28 flat-bottom ports. Most low-pressure valves of this type have very shallow threaded ports, which typically preclude the use of our Flangeless Fittings. However, by first threading our P-671 Adapter into the valve port(s), you can effectively use standard 1/4-28 fittings to connect your tubing into the backside of the adapter body. This also saves "wear and tear" on the threads in the valve ports.



Metric Threaded Adapters

Our versatile Metric Threaded Adapters are used specifically to effectively attach connectors with different threads. We designed these adapters to work with English to Metric threaded geometries. Manufactured from Stainless Steel, PEEK or Tefzel™ (ETFE) they deliver excellent solvent resistance.

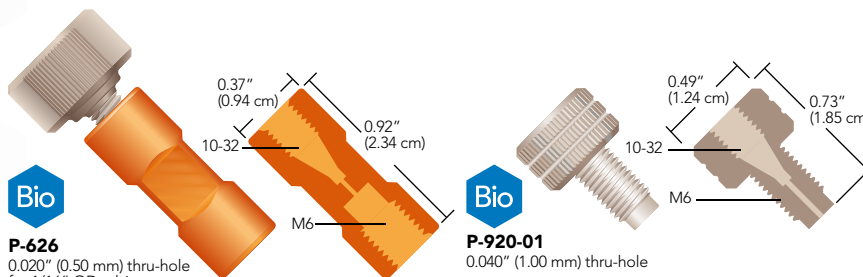

Bio

P-626
0.020" (0.50 mm) thru-hole
for 1/16" OD tubing
Includes (1) F-300

Bio

P-920-01
0.040" (1.00 mm) thru-hole

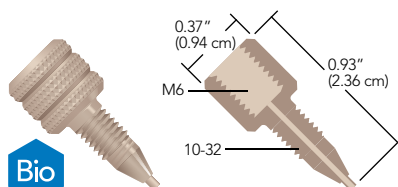

Bio

P-650
0.030" (0.75 mm) thru-hole

Bio

P-670
0.030" (0.75 mm) thru-hole

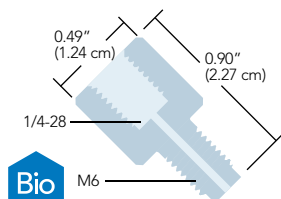

Bio

P-694
0.040" (1.00 mm) thru-hole

Bio

P-673
0.040" (1.00 mm) thru-hole

RELATED PRODUCTS

- › For an alternative to the Female M6 Adapters presented above, try a P-602 or P-622 Low Pressure Metric Union from page 84, along with the appropriate Metric Flangeless Fittings on page 43.
- › To direct connect your tubing into a flat-bottom port, find the appropriate Flangeless or Super Flangeless™ Fittings on page 45 and page 39 respectively.
- › Need metric fittings for your connections? See page 43.

Threaded Adapters (Cont.)



National Pipe Thread Adapters

These adapters make connections to female 1/8" and 1/4" National Pipe Thread (NPT) ports.

Manufactured from PEEK polymer, our NPT Adapters are durable and chemically resistant. We provide versions with either 1/4-28 or 5/16-24 flat-bottom threads, suitable for most low pressure applications.

Please Note: Wrap the threads on the NPT side of these adapters with thread seal tape (plumber's tape) to ensure a leak-free seal.

RELATED PRODUCTS

Replacement fittings for these adapters are located on the pages indicated below:

	Page(s)
1/4-28 for 1/8" OD tubing	41
5/16-24 for 1/8" OD tubing	41, 56
5/16-24 for 3/16" OD tubing	41

Other tubing/fitting combinations are available. For more information, please contact your local Distributor or IDEX Health & Science directly.

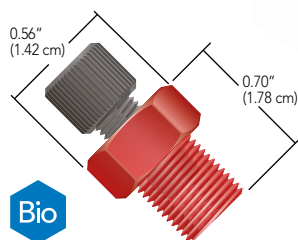

U-510
1/8" NPT to 1/4-28 Flat-Bottom Female Adapter for 1/8" OD tubing Includes (1) XP-308 Fitting

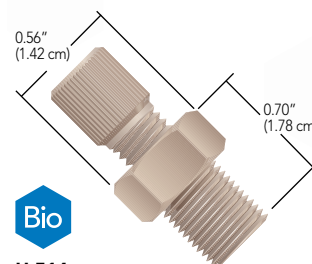

U-514
1/8" NPT to 5/16-24 Flat-Bottom Female Adapter for 3/16" OD tubing Includes (1) XP-132 Fitting

APPLICATION NOTE

Our U-500 and U-510 NPT Adapters are great for attaching 1/8" OD fluoropolymer sparging lines to sparging gas tank regulating valves. Simply thread the appropriately sized NPT Adapter into the valve's receiving port and then attach your sparging tubing to the adapter body using the fittings provided.

Threaded Adapters

Part No.	Description	Includes	Thru-hole	Swept Volume	Pressure Rating	Qty.		
ENGLISH THREADED ADAPTERS								
6000-076	PEEK Adapter, 5/16-24 C, M to 10-32 C, F	N/A	0.066" (1.70 mm)	49.8 µL	3,000 psi (207 bar)	ea.		
P-135	PEEK Adapter, 5/16-24 FB, F to 1/4-28 F	N/A	0.080" (2.05 mm)	4.1 µL	1,000 psi (69 bar)	ea.		
P-627	PEEK Adapter, 10-32 C, F to 1/4-28 FB, F	(1) F-300	0.020" (0.50 mm)	0.30 µL	1,000 psi (69 bar)	ea.		
P-681	PCTFE Adapter, 5/16-24 FB, F to 1/4-28 FB, M	N/A	0.125" (3.20 mm)	96.6 µL	1,000 psi (69 bar)	ea.		
P-684	PCTFE Adapter, 1/2-20 FB, F to 1/4-28 FB, M	N/A	0.130" (3.30 mm)	121.7 µL	250 psi (17 bar)	ea.		
P-718	PCTFE Adapter, 5/16-24 FB, M to 1/4-28 FB, F	N/A	0.040" (1.00 mm)	10.3 µL	1,000 psi (69 bar)	ea.		
U-659	PEEK Adapter, 5/16-24 FB, F to 1/2-20 FB, F	(1) XU-655	Tapered**	42.0 µL	250 psi (17 bar)	ea.		
U-665	PEEK Adapter, 1/2-20 FB, F to 1/4-28 FB, F	(1) XU-655	0.063" (1.60 mm)	6.6 µL	250 psi (17 bar)	ea.		
P-652	PEEK Adapter, 1/4-28 FB, F to 10-32 C, M	N/A	0.030" (0.75 mm)	6.7 µL	1,000 psi (69 bar)	ea.		
P-654	PEEK Adapter, 1/4-28 FB, F to 10-32 C, M, Extra Long	N/A	0.030" (0.75 mm)	9.5 µL	1,000 psi (69 bar)	ea.		
P-669-01	PEEK Adapter, 10-32 C, F to 1/4-28 FB, M	N/A	0.040" (1.00 mm)	6.6 µL	1,000 psi (69 bar)	ea.		
P-671	PTFE Adapter, 1/4-28 FB, F to 1/4-28 FB, M	N/A	0.040" (1.00 mm)	8.0 µL	1,000 psi (69 bar)	ea.		
P-672	PEEK Adapter, 1/4-28 FB, F to 10-32 FB, M	N/A	0.050" (1.25 mm)	11.4 µL	1,000 psi (69 bar)	ea.		
METRIC M6 THREADED ADAPTERS								
P-626	PEEK Adapter, 10-32 C, F to M6 FB, F	(1) F-300	0.020" (0.50 mm)	0.3 µL	1,000 psi (69 bar)	ea.		
P-650	PEEK Adapter, M6 FB, F to 10-32 C, M Standard	N/A	0.030" (0.75 mm)	6.7 µL	1,000 psi (69 bar)	ea.		
P-670	PCTFE Adapter, M6 FB, F to 1/4-28 FB, M	N/A	0.030" (0.75 mm)	2.6 µL	1,000 psi (69 bar)	ea.		
P-673	PCTFE Adapter, 5/16-24 FB, F to M6 FB, M	N/A	0.040" (1.00 mm)	9.9 µL	1,000 psi (69 bar)	ea.		
P-694	PCTFE Adapter, 1/4-28 FB, F to M6 FB, M	N/A	0.040" (1.00 mm)	11.3 µL	1,000 psi (69 bar)	ea.		
P-920-01	PEEK Adapter, 10-32 C, F to M6 FB, M	N/A	0.040" (1.00 mm)	8.0 µL	1,000 psi (69 bar)	ea.		
1/8" MALE NATIONAL PIPE THREAD ADAPTERS								
Part No.	Description	Color	Tubing OD	Includes	Thru-hole	Swept Volume	Pressure Rating	Qty.
U-510	PEEK 1/8" NPT, M to 1/4-28 FB, F Adapter	Red	1/8"	(1) XP-308	0.062" (1.60 mm)	17.3 µL	500 psi (34 bar)	ea.
U-514	PEEK 1/8" NPT, M to 5/16-24 FB, F Adapter	Natural	3/16"	(1) XP-132	0.125" (3.2 mm)	70.4 µL	500 psi (34 bar)	ea.
1/4" MALE NATIONAL PIPE THREAD ADAPTERS								
U-500	PEEK 1/4" NPT, M to 1/4-28 FB, F Adapter	Red	1/8"	(1) XP-308	0.062" (1.60 mm)	17.3 µL	500 psi (34 bar)	ea.
U-504	PEEK 1/4" NPT, M to 5/16-24 FB, F Adapter	Natural	3/16"	(1) XP-132	0.125" (3.2 mm)	70.4 µL	500 psi (34 bar)	ea.

F = Female (internal) threads; M = Male (external) threads; XL = extra long; C = Coned; FB = Flat-Bottom

* The pressure rating of this adapter exceeds the pressure holding ability of the fittings and tubing used with it.

** Thru-hole tapers from 0.188" (4.80 mm) to 0.125" (3.20 mm).



High Pressure Mixing Tees

Mixing Tees utilize a specifically engineered internal geometry to efficiently mix two fluid streams into one combined stream. Mixing Tees are ideal for microbore or analytical gradient HPLC. These mixing tees are specifically designed for high pressure applications.

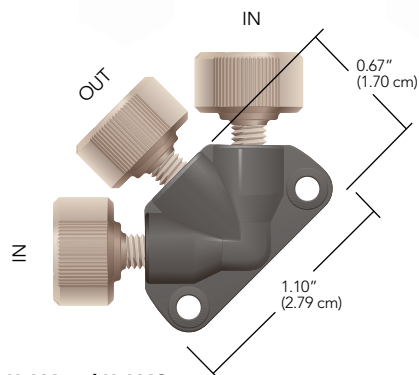

U-466 and U-466S
Static Mixing Tees with F-300 Fingertight Fittings for 1/16" OD tubing

Static Mixing Tees

- › PEEK body with two-piece fingertight fittings
- › Low swept volume

Static Mixing Tees are ideal for microbore or analytical gradient HPLC. They have a low swept volume of 2.2 μL (includes frit volume) and are designed for flow rates of 0.5 to 3 mL/min and a maximum pressure of 5,000 psi (345 bar). The back pressure caused by the tee is typically only 10 to 20 psi (0.7 to 1.4 bar) at these flow rates. The thru-holes are 0.020" (0.50 mm) and the center port features a 10 μm UHMWPE or stainless steel frit that aids mixing.

NOTE

- › Turbulent mixing of solvents often increases outgassing. To maintain a bubble-free fluid pathway, we recommend solvent degassing when using this product.
- › The frit incorporated into our U-466 and U-466S Static Mixing Tees is not replaceable. If it becomes clogged, the Mixing Tee must be replaced.

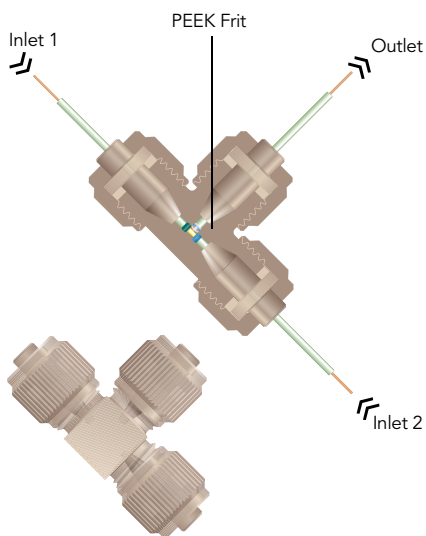

M-540
Micro Static Mixing Tee 0.010" thru-hole with fittings included (tubing and tubing sleeves not included)

Micro Static Mixing Tee

- › Constructed of inert PEEK and PCTFE
- › Low swept volume of 0.95 μL
- › Designed for flow rates of 20–250 $\mu\text{L}/\text{min}$

Our Micro Static Mixing Tee utilizes a specifically engineered internal geometry to efficiently mix two fluid streams into one combined stream. The center port also features a 0.5 μm porosity PEEK polymer frit to aid in mixing. This frit adds a maximum of 20 psi (1.4 bar) back pressure to most systems (within the stated flow rate range). The Mixing Tee handles a maximum pressure of 5,000 psi (345 bar) when directly connecting 1/16" OD tubing, or up to 4,000 psi (276 bar) with capillary tubing when using our NanoTight™ Fittings and Tubing Sleeves (page 37).

RELATED PRODUCTS

- › See our Vacuum Degassing Systems on page 154.
- › Our standard Static Mixing Tees are designed for flow rates from 0.5 mL/min to 3 mL/min.

High Pressure Mixing Tees (Cont.)



APPLICATION NOTE

Several researchers use our PEEK MicroTee to introduce ionizing voltage to their fluid stream just prior to a Mass Spectrometer¹. MicroTees are well suited for this application due to advantageous internal geometry and PEEK polymer's electrical resistance. The materials required for this setup are as follows: one gold or platinum conducting wire, one P-775 or P-875 MicroTee (this page), one MicroTight Tubing Sleeve (page 52) for the conducting wire (as needed to accommodate wire diameter), and at least two more MicroTight Tubing Sleeves (page 52) to connect your capillary tubing.

To set up a similar connection, first thread your wire through the appropriate tubing sleeve, if necessary, with the wire extending beyond both ends of the sleeve. Slip the female nut included with the MicroTee over the wire or sleeved wire, followed by the ferrule — ensuring the wire (and its sleeve) extends well past the end of the ferrule tip. Align the tip of the wire with the thru-hole of the MicroTee and gently insert the wire until it bottoms out. Now finger tighten the female nut into place. Attach your flow path tubing to the MicroTee's two other available ports, following the instructions provided with the MicroTee.

Begin fluid flow through the tee and apply voltage to the conducting wire lead. This setup typically provides effective electrospray ionization in applications having a flow rate of 100 $\mu\text{L}/\text{min}$ or greater.

¹ One such paper describing pioneering electrospray work: *Protein Identification at the Low Femtomole Level from Silver-Stained Gels Using a New Fritless Electrospray Interface for Liquid Chromatography-Microspray and Nanospray Mass Spectrometry*. Christine L. Gatlin, Gerd R. Kleemann, Lara G. Hays, Andrew J. Link, John R. Yates III (1998) *Analytical Biochemistry* 263, 93-101.

MicroTee & Cross for Capillary Tubing

- › Direct connect 1/16", 1/32", 360 μm OD tubing, plus other capillary tubing
- › Low swept volume

Use our MicroTees and MicroCrosses to join capillary tubing. All of these products are made entirely of PEEK and have 0.006" (0.150 mm) thru-holes, with resulting swept volumes ranging from 29 to 81 nL.



NOTE

- › Use only the ferrules supplied with each connector — they are not interchangeable. Replacement ferrules and female nuts are available on page 35. For MicroUnions, MicroTees, and MicroCrosses for UHPLC applications, see page 72.

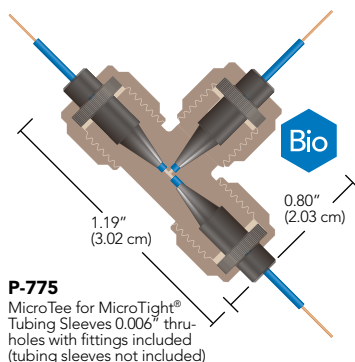

P-775
MicroTee for MicroTight[®] Tubing Sleeves 0.006" thru-holes with fittings included (tubing sleeves not included)

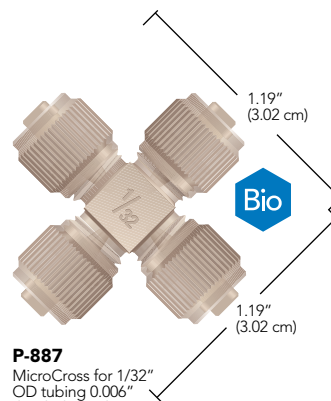

P-887
MicroCross for 1/32" OD tubing 0.006" thru-holes with fittings included

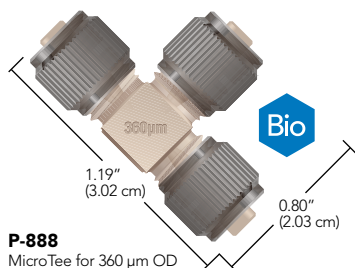

P-888
MicroTee for 360 μm OD tubing 0.006" thru-holes with fittings included

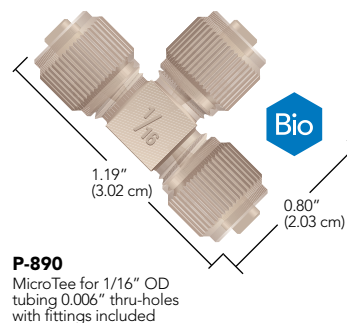

P-890
MicroTee for 1/16" OD tubing 0.006" thru-holes with fittings included

High Pressure Mixing Tees

Part No.	Description	Threads	Includes	Thru-hole	Swept Volume	Pressure Rating	Qty.
STATIC MIXING TEE							
U-466	PEEK Static Mixing Tee for 1/16" OD Tubing, 10 μm UHMWPE Frit	10-32 Coned	(3) F-300	0.020" (0.50 mm)	2.2 μL	5,000 psi (345 bar)	ea.
U-466S	PEEK Static Mixing Tee for 1/16" OD Tubing, 10 μm SST Frit	10-32 Coned	(3) F-300	0.020" (0.50 mm)	2.2 μL	5,000 psi (345 bar)	ea.
MICRO STATIC MIXING TEE							
M-540	PEEK Micro Static Mixing Tee, for 1/16" OD Tubing	5/16-24 Coned	(3) F-132/P-416	0.010" (0.250 mm)	0.95 μL	5,000 psi (345 bar)	ea.
MICROTEE, MICROCROSS AND MICROELBOW							
P-775	PEEK MicroTee for MicroTight Sleeves	5/16-24 Coned	(3) F-172, (3) P-416	0.006" (0.150 mm)	29 nL	4,000 psi (276 bar)	ea.
P-777	PEEK MicroCross for MicroTight Sleeves	5/16-24 Coned	(4) F-172, (4) P-416	0.006" (0.150 mm)	38 nL	4,000 psi (276 bar)	ea.
P-875	PEEK MicroTee with Mounting Hole, for MicroTight Sleeves	5/16-24 Coned	(3) F-172, (3) P-416	0.006" (0.150 mm)	29 nL	4,000 psi (276 bar)	ea.
P-885	PEEK MicroTee for 1/32" OD Tubing	5/16-24 Coned	(3) F-112, (3) P-416	0.006" (0.150 mm)	29 nL	5,000 psi (345 bar)	ea.
P-887	PEEK MicroCross for 1/32" OD Tubing	5/16-24 Coned	(4) F-112, (4) P-416	0.006" (0.150 mm)	38 nL	5,000 psi (345 bar)	ea.
P-888	PEEK MicroTee for 360 μm OD Tubing	5/16-24 Coned	(3) F-152, (3) P-416BLK	0.006" (0.150 mm)	29 nL	5,000 psi (345 bar)	ea.
P-889	PEEK MicroCross for 360 μm OD Tubing	5/16-24 Coned	(4) F-152, (4) P-416BLK	0.006" (0.150 mm)	38 nL	5,000 psi (345 bar)	ea.
P-890	PEEK MicroTee for 1/16" OD Tubing	5/16-24 Coned	(3) F-132, (3) P-416	0.006" (0.150 mm)	58 nL	5,000 psi (345 bar)	ea.
P-891	PEEK MicroCross for 1/16" OD Tubing	5/16-24 Coned	(4) F-132, (4) P-416	0.006" (0.150 mm)	81 nL	5,000 psi (345 bar)	ea.



High Pressure Unions

PEEK ZDV Unions

Our PEEK zero-dead-volume (ZDV) Unions come complete with two F-300 Fingertight Fittings for 1/16" OD tubing and are pressure rated to 5,000 psi (344 bar).

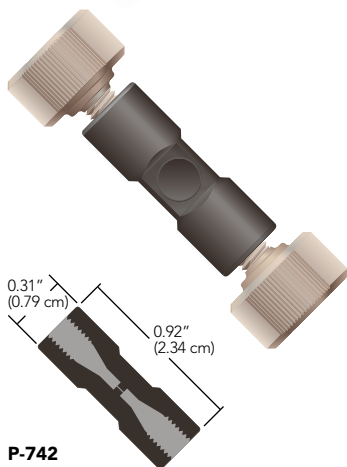

P-742
PEEK ZDV Union
0.010" thru-hole with
F-300 Fittings

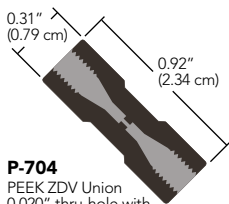

P-704
PEEK ZDV Union
0.020" thru-hole with
F-300 Fittings

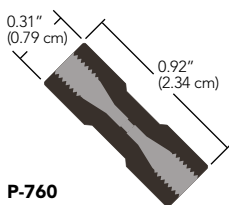

P-760
PEEK ZDV Union
0.050" thru-hole with
F-300 Fittings

Bio-Inert UHPLC Unions

- › Unique, Patent-Pending Process allows a fully-PEEK fluid contact area combined with the strength of stainless steel
- › Pressure rated to 17,400 psi (1,200 bar)
- › Two inner diameters available: 0.008" and 0.016"

These unions are specifically engineered for Bio-Inert UHPLC applications. Combining the physical strength of 316 stainless steel with the inertness and biocompatibility of an all-PEEK fluid pathway, these unions will work well in applications where pressures reach up to 17,400 psi (1,200 bar) — without allowing metal contact by the fluid.

Neither union comes with fittings, but can be paired successfully with any 10-32 coned fitting that uses a polymer nose or ferrule.

Note: All-stainless steel fittings should NOT be used with these unions, as they will damage the internal conical seat.

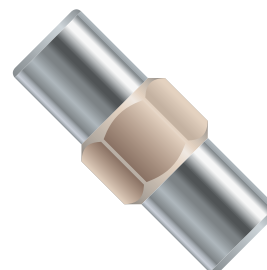

UP-700
Bio-Inert UHPLC Union 0.008" thru-hole for 1/16" OD tubing

NanoTight™ Union

NanoTight Unions improve capillary tubing connections in several ways. The internal design of the union greatly reduces the incidence of tubing misalignment. When using 1/16" OD tubing sleeves (found on page 52) to connect capillary tubing, the webbed thru-hole minimizes breaking of fused silica while adding only miniscule swept volume. The results are fewer blockages, fewer flow rate reductions and fewer back pressure problems.

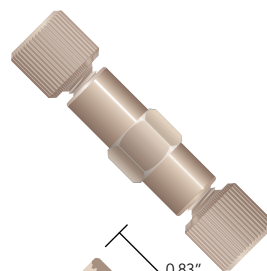

P-779
NanoTight Union
0.005" thru-hole with
F-331N Fittings

Part No.	Description	Threads	Includes	Thru-hole	Swept Volume	Pressure Rating	Qty.
BIO-INERT UHPLC UNIONS							
UP-700	Bio-Inert UHPLC Union for 1/16" OD Tubing, Natural (Tan)	10-32 Coned	N/A	0.008" (0.20 mm)	0.05 µL	17,400 psi (1,200 bar)	ea.
PEEK ZDV UNIONS							
P-704	PEEK Union for 1/16" OD Tubing	10-32 Coned	(2) F-300	0.020" (0.50 mm)	0.28 µL	5,000 psi (344 bar)	ea.
P-742	PEEK Union for 1/16" OD Tubing	10-32 Coned	(2) F-300	0.010" (0.25 mm)	0.07 µL	5,000 psi (344 bar)	ea.
P-760	PEEK Union for 1/16" OD Tubing	10-32 Coned	(2) F-300	0.050" (1.25 mm)	1.2 µL	5,000 psi (344 bar)	ea.
NANOTIGHT UNION							
P-779	PEEK NanoTight Union for 1/16" OD Tubing and Tubing Sleeves	10-32 Coned	(2) F-331N	0.005" (125 µm)	8 nL	5,000 psi (344 bar)	ea.

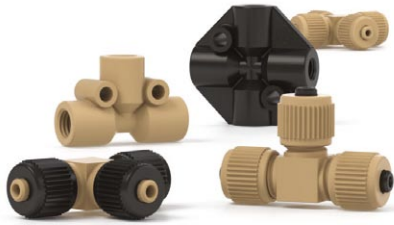

High Pressure PEEK Tees & Crosses

- › Highest pressure holding flat-bottom fitting system we offer
- › Eliminates loosening of fittings due to tubing twist
- › Excellent for Tubing Assemblies
- › Holds tight even through vibration

Our PEEK Tees and Crosses include high pressure F-300 PEEK Fingertight Fittings — allowing maximum operating pressures to 3,500 psi (241 bar) when used with 1/16" OD PEEK or stainless steel tubing.

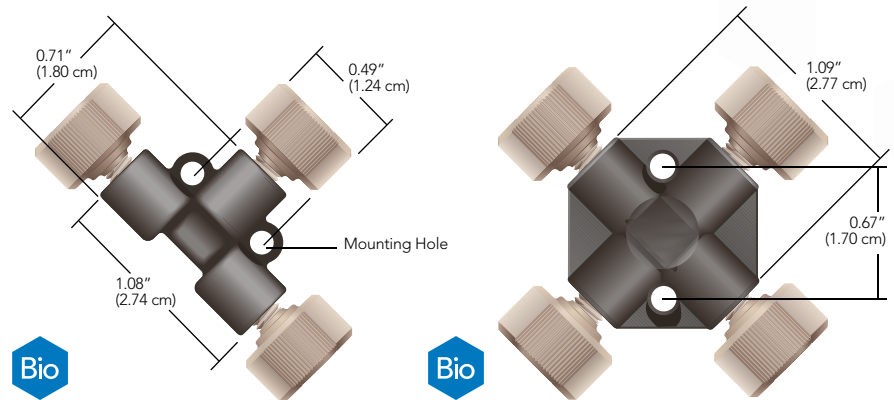

P-727 PEEK Tee
0.020" thru-hole with F-300 Fittings

P-729 PEEK Cross
0.020" thru-hole with F-300 Fittings

PEEK 7-Port Manifold

Combine several streams into one or split one fluid stream into several. This PEEK 7-Port Manifold comes complete with F-331 Fingertight Fittings for 1/16" OD tubing and offers a pressure rating of 5,000 psi (345 bar). Seal unused ports with any of our polymer 10-32 coned plugs on page 55.

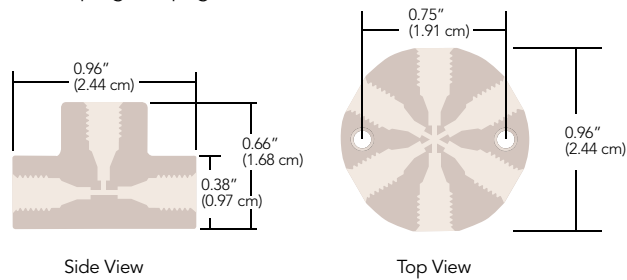

P-170
PEEK 7-Port Manifold 0.020" thru-holes with F-331 Fittings

Part No.	Description	Threads	Includes	Thru-hole	Swept Volume	Pressure Rating	Qty.
PEEK TEES AND CROSSES							
P-727	PEEK Tee for 1/16" OD Tubing	10-32 Coned	(3) F-300	0.020" (0.50 mm)	0.57 μ L	3,500 psi (241 bar)	ea.
P-728	PEEK Tee for 1/16" OD Tubing	10-32 Coned	(3) F-300	0.050" (1.25 mm)	3.0 μ L	3,500 psi (241 bar)	ea.
P-729	PEEK Cross for 1/16" OD Tubing	10-32 Coned	(4) F-300	0.020" (0.50 mm)	0.72 μ L	3,500 psi (241 bar)	ea.
PEEK MANIFOLD							
P-170	PEEK 7-Port Manifold for 1/16" OD Tubing	10-32 Coned	(7) F-331	0.020" (0.50 mm)	2.2 μ L	5,000 psi (345 bar)	ea.

High Pressure MicroTight® Unions

Conductive MicroTight Union

The Conductive MicroTight Union manufactured by IDEX Health & Science provides an excellent opportunity to introduce voltage into an electrospray or capillary electrophoresis system. With an extremely low internal volume of 16 nL, this union can be placed inline with 360 µm OD capillary tubing. Mount and apply voltage to these unions using our Insulating Mounting Bracket below.

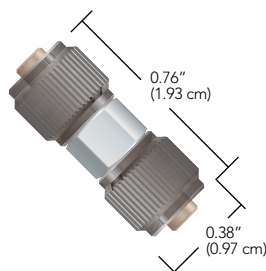

M-572

Conductive MicroTight Union for 360 µm OD tubing with fittings and Capsule Union included

APPLICATION NOTE

For an example of using a Conductive MicroTight Union in a pressure driven ion preconcentration application see: "Self-Sealed Vertical Polymeric Nanoporous Junctions for High Throughput Nanofluidic Applications."

Sun Jae Kim and Jong Yoon Han. *Analytical Chem.* 2008, 80: 3507-3511.

RELATED PRODUCTS

- » Easily integrate the Conductive MicroTight Union into your system with our Insulating Mounting Bracket, shown on page 79.

MicroTight® Connectors for Capillary Tubing

Connect two pieces of capillary tubing with our PEEK MicroTight Connectors. The True ZDV Unions allow two pieces of tubing to connect directly to each other — using the included gauge plug to ensure proper alignment. The standard union and elbow both feature a 0.006" (0.150 mm) thru-hole, adding only a small amount of additional flow-path volume to help ensure proper chromatographic results.

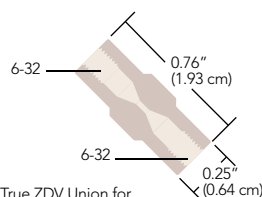

P-720

MicroTight True ZDV Union for use with MicroTight Sleeves with fittings and gauge plug included

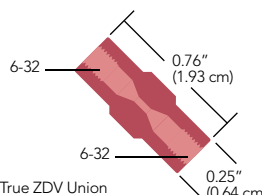

P-771

MicroTight True ZDV Union for 1/32" OD tubing with fittings and gauge plug included

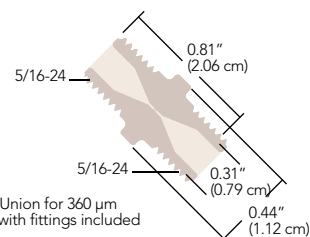

P-772

MicroTight Union for 360 µm OD tubing with fittings included

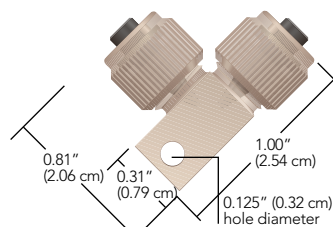

P-874

MicroElbow for MicroTight Tubing Sleeves with fittings included

Part No.	Description	Threads	Includes	Thru-hole	Swept Volume	Pressure Rating	Qty.
MICROTIGHT UNIONS							
P-720	PEEK True ZDV Union for MicroTight Sleeves	6-32 Coned	(2) F-125, (1) P-553	N/A	N/A	4,000 psi (276 bar)	ea.
P-771	PEEK True ZDV Union for 1/32" OD Tubing	6-32 Coned	(2) F-126S, (1) P-553	N/A	N/A	5,000 psi (345 bar)	ea.
P-772	PEEK Union for 360 µm OD Tubing	5/16-24 Coned	(2) F-152, (2) P-416BLK	0.006" (0.150 mm)	5 nL	5,000 psi (345 bar)	ea.
P-874	PEEK MicroElbow for MicroTight Sleeves	5/16-24 Coned	(2) F-172, (2) P-416	0.006" (0.150 mm)	20 nL	4,000 psi (276 bar)	ea.
REPLACEMENT GAUGE PLUGS (TO ACHIEVE TRUE ZDV CONNECTIONS WITH OUR P-720 AND P-771 UNIONS)							
P-553	Gauge Plug, Delrin®	6-32 Coned	N/A	N/A	N/A	N/A	ea.
CONDUCTIVE MICROTIGHT UNIONS							
M-572	Conductive Union for 360 µm OD Tubing, PEEK/SST	5/16-24 Coned	(2) F-152, (2) P-416BLK, (1) M-128NF	0.011" (0.279 mm)	16 nL	5,000 psi (345 bar)	ea.



High Pressure Stainless Steel Tees & Crosses

These 316 stainless steel connectors come complete with 10-32 stainless steel fittings for use with 1/16" OD tubing and are rated to 20,000 psi (1,380 bar). They are compatible with any 10-32 coned threaded fittings.

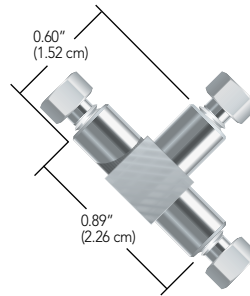

U-428 Stainless Steel Tee
0.020" thru-hole with U-400 and U-401 Fittings

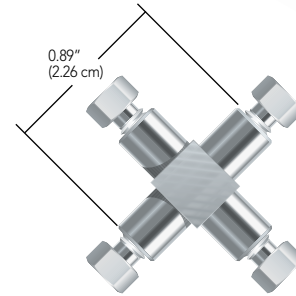

U-430 Stainless Steel Cross
0.020" thru-hole with U-400 and U-401 Fittings

Part No.	Description	Threads	Includes	Thru-hole	Swept Volume	Pressure Rating	Qty.
VHP TEE FOR 1/16" OD TUBING							
U-428	Stainless Steel Tee for 1/16" OD Tubing	10-32 Coned	(3) U-400, (3) U-401	0.020" (0.50 mm)	0.57 µL	20,000 psi (1,380 bar)	ea.
U-429	Stainless Steel Tee for 1/16" OD Tubing	10-32 Coned	(3) U-400, (3) U-401	0.040" (1.00 mm)	2.1 µL	20,000 psi (1,380 bar)	ea.
U-430	Stainless Steel Cross for 1/16" OD Tubing	10-32 Coned	(4) U-400, (4) U-401	0.020" (0.50 mm)	0.72 µL	20,000 psi (1,380 bar)	ea.
U-431	Stainless Steel Cross for 1/16" OD tubing	10-32 Coned	(4) U-400, (4) U-401	0.040" (1.00 mm)	2.5 µL	20,000 psi (1,380 bar)	ea.

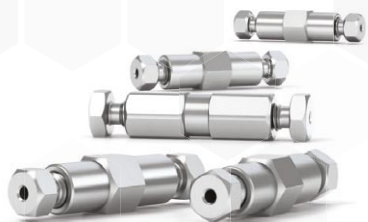

VHP Stainless Steel ZDV Unions

- › Supplied with fittings for 1/16" OD or 1/8" OD tubing
- › Manufactured from 316 stainless steel
- › All union assemblies rated to 20,000 psi (1,380 bar) or higher

NOTE

It is possible to order the products on this page without the fittings. Simply use a -01 at the end of the product number to order the union body without fittings.

Our high pressure, zero-dead-volume (ZDV) unions are precision machined from 316 stainless steel, carefully passivated, then thoroughly rinsed. Each comes complete with stainless steel nuts and ferrules.

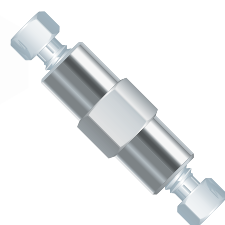

0.31" (0.79 cm)
0.84" (2.13 cm)

U-402
ZDV Union
0.020" thru-hole
for 1/16" OD tubing

0.31" (0.79 cm)
0.84" (2.13 cm)

U-435
ZDV Union
0.010" thru-hole
for 1/16" OD tubing

0.31" (0.79 cm)
0.84" (2.13 cm)

U-438
True ZDV Union
0.067" thru-hole
for 1/16" OD tubing

0.38" (0.97 cm)
1.20" (3.05 cm)

1593
ZDV Union
0.050" thru-hole
for 1/8" OD tubing



U-411
NanoTight™ Union
0.007" thru-hole
for 1/16" OD tubing

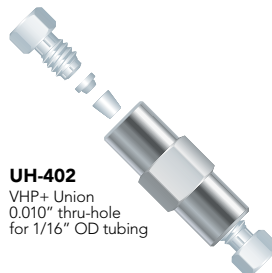

UH-402
VHP+ Union
0.010" thru-hole
for 1/16" OD tubing



U-322
VICI® (Valco) Compatible
ZDV Union 0.020" thru-hole
for 1/16" OD tubing



U-412
Waters Compatible
ZDV Union 0.020" thru-hole
for 1/16" OD tubing

0.31" (0.79 cm)
1.02" (2.59 cm)

Part No.	Description	Threads	Includes	Thru-hole	Swept Volume	Pressure Rating	Qty.
VHP STAINLESS STEEL ZDV UNIONS							
1593	Stainless Steel Union for 1/8" OD Tubing	1/4-28 Coned	(2) C-235/C-236	0.050" (1.25 mm)	1.48 µL	20,000 psi (1,380 bar)	ea.
U-402	Stainless Steel Union for 1/16" OD Tubing	10-32 Coned	(2) U-400/U-401	0.020" (0.50 mm)	0.13 µL	20,000 psi (1,380 bar)	ea.
U-411	Stainless Steel Union for 1/16" OD Tubing	10-32 Coned	(2) U-400/U-401	0.007" (178 µm)	13 nL	20,000 psi (1,380 bar)	ea.
U-435	Stainless Steel Union for 1/16" OD Tubing	10-32 Coned	(2) U-400/U-401	0.010" (0.25 mm)	20 nL	20,000 psi (1,380 bar)	ea.
U-438	Stainless Steel Union for 1/16" OD Tubing	10-32 Coned	(2) U-400/U-401, (1) P-554 Gauge Plug	0.067" (1.70 mm)	Near 0 µL	20,000 psi (1,380 bar)	ea.
UH-402	VHP+ Stainless Steel Union for 1/16" OD Tubing	10-32 Coned	(2) VHP-200	0.010" (0.25 mm)	20 nL	30,000 psi (2,070 bar)	ea.
VICI (VALCO) COMPATIBLE ZDV UNION							
U-322	Stainless Steel Union for 1/16" OD Tubing	10-32 Coned	(2) U-320/U-321	0.020" (0.50 mm)	0.15 µL	20,000 psi (1,380 bar)	ea.
WATERS® COMPATIBLE ZDV UNION							
U-412	Stainless Steel Union for 1/16" OD Tubing	10-32 Coned	(2) U-410/U-401	0.020" (0.50 mm)	0.10 µL	20,000 psi (1,380 bar)	ea.



VHP Tees & Crosses

Our VHP Stainless Steel Tees and Crosses are precision machined from durable stainless steel. It is mechanically designed for bringing together three or four pieces of tubing. Our VHP Tees & Crosses have an extremely high pressure rating of 30,000 psi (2070 bar).

VHP Tees & Crosses for Capillary Tubing

- › Direct-connect either 360 μm or 1/32" OD tubing — no sleeves required!
- › Available in both tee and cross configurations
- › Pressure rated to 15,000 psi (1,034 bar)

To help facilitate multi-port connections in UHPLC applications, our experts have developed a line of MicroTees and MicroCrosses, manufactured from stainless steel and featuring small thru-holes and very low internal volume. Additionally, the stainless steel construction allows these products to be used in applications where electrical conductivity is desired.

Included with the MicroTees and MicroCrosses are the VHP MicroFerrules found on page 59. The P-278 Extender Tool on page 33 can be used to tighten the female nuts that are included with these connectors.

APPLICATION NOTE

Why 1/32" OD Tubing and 360 μm OD Tubing?

IDEX Health & Science has focused strongly on the development of a variety of connectors and accessories for 1/32" OD tubing and 360 μm OD tubing. We have focused on these specific sizes due to their overwhelming popularity in analytical instruments, especially where micro and nano-scale analyses are being performed. By creating products designed for these popular sizes, the overall connection is easier to make and generally holds to increased pressures over connections where tubing sleeves are involved.

VHP Tee for 1/16" OD Tubing

IDEX Health & Science offers this Very High Pressure (VHP) Tee Connector, designed to bring three pieces of tubing together. The all-316 stainless steel connector is designed for 1/16" OD tubing and is pressure rated to 30,000 psi (2,070 bar).

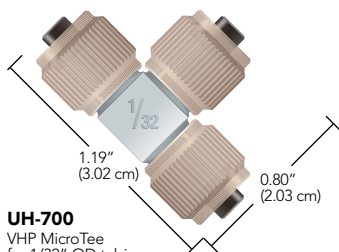

UH-700
VHP MicroTee
for 1/32" OD tubing
with fittings included

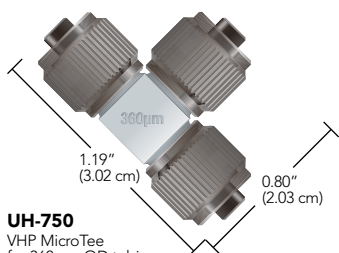

UH-750
VHP MicroTee
for 360 μm OD tubing
with fittings included

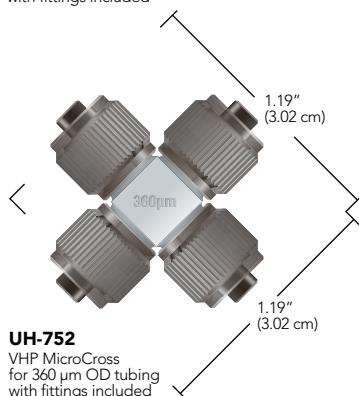

UH-752
VHP MicroCross
for 360 μm OD tubing
with fittings included

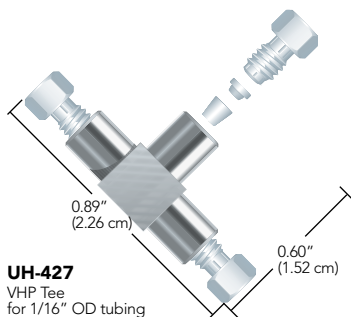

UH-427
VHP Tee
for 1/16" OD tubing
with fittings included

Part No.	Description	Threads	Includes	Thru-hole	Swept Volume	Pressure Rating	Qty.
VHP TEE FOR 1/16" OD TUBING							
UH-427	VHP Tee for 1/16" OD Tubing, SST	10-32 Coned	(3) VHP-200	0.020" (0.50 mm)	0.57 μL	30,000 psi (2,070 bar)	ea.
VHP TEES & CROSSES FOR CAPILLARY TUBING							
UH-700	VHP MicroTee for 1/32" OD Tubing, PEEK/SST	5/16-24 Coned	(3) PK-112, (3) P-416	0.010" (0.25 mm)	84 nL	15,000 psi (1,034 bar)	ea.
UH-750	VHP MicroTee for 360 μm OD Tubing, PEEK/SST	5/16-24 Coned	(3) PK-152, (3) P-416BLK	0.010" (0.25 mm)	84 nL	15,000 psi (1,034 bar)	ea.
UH-752	VHP MicroCross for 360 μm OD Tubing, PEEK/SST	5/16-24 Coned	(4) PK-152, (4) P-416BLK	0.010" (0.25 mm)	101 nL	15,000 psi (1,034 bar)	ea.



VHP MicroTight[®] Unions

- › Featuring stainless steel bodies and PK/PEEK fittings
- › Pressure rated up to 15,000 psi (1,034 bar)
- › Options to direct-connect both 1/32" OD tubing and 360 µm OD tubing

VHP Unions for Capillary Tubing

IDEX Health & Science has expanded its line of specialized fittings and connectors for UHPLC applications to include several innovative unions and adapters.

Two of these products — the UH-432 and UH-436 — follow the design of our popular Mini MicroFilters (see page 109) and allow a convenient union between either 1/32" OD tubing or 360 µm OD tubing. Each features a stainless steel union body and a unique stainless steel union capsule, enabling both excellent chemical compatibility as well as conductivity, making these a great choice for electrical interfacing in certain LC-MS applications. Each is also coupled with direct-connect ferrules made from our proprietary PEEK polymer blend (PK), allowing tubing connections up to 15,000 psi (1,034 bar). *(Please Note: While these connectors can be used at elevated pressures, they are not recommended for applications above 100 °C.)*

The UH-632 is a more traditionally designed connector, incorporating internally threaded ports. The union (UH-632) features a true ZDV (zero dead volume) connection between both tubes. This unique product is coupled with our one-piece Ultra-High Performance Fingertight fittings manufactured from our proprietary PEEK polymer blend, allowing them to be used in high temperature applications (up to 200 °C) at pressures up to 6,000 psi (414 bar) — or use these connectors at room temperature up to 15,000 psi (1,034 bar)!

The 1959-01 is a new VHP union designed to accept the popular M4x0.7 threaded fittings for 1/32" OD tubing. These unions will work nicely with both the VHP-900 fittings (found on page 59) as well as the reusable VHP-920 (found on page 60).

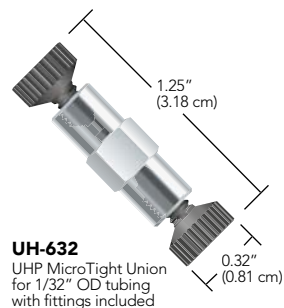
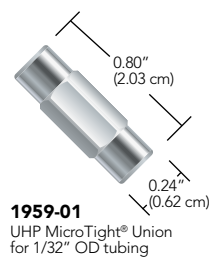
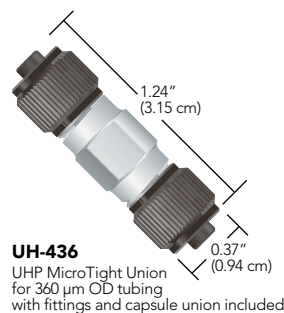
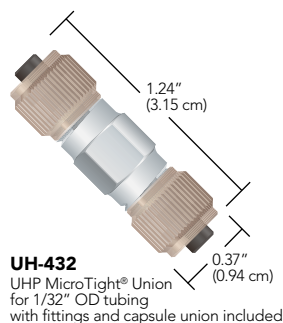

VHP MicroTight® Unions (Cont.)

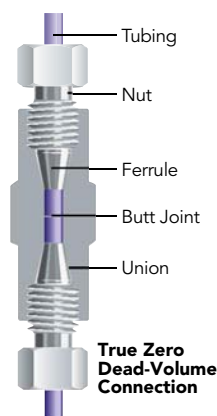

APPLICATION NOTE

What is a True ZDV Union?

True zero dead volume (ZDV) unions are designed so that the two joined pieces of tubing butt perfectly together as shown in the image to the right. These products have no swept volume contained within the union body. The fluid moves directly from one tube into another in this type of connector.

When using true ZDV unions, it is important to take care to ensure connecting tubing has burr-free 90 degree ends. Find tubing cutters on page 28 to assist with cleanly cutting polymer and fused silica tubing. Gauge plugs are supplied with True ZDV Unions to assist with assembly. With the gauge plug inserted into one side of the union, a hard stop is created for the tubing to bottom out against as it is connected to the opposite port. The gauge plug is removed and then the second piece of tubing is connected, using the first piece of tubing to bottom out against resulting in the two tubes joined together in the center of the union.



RELATED PRODUCTS

- › Find replacement VHP fittings on page 59.
- › Find Fused Silica tubing on page 16.
- › Find 1/32" OD Stainless Steel tubing on page 19.
- › To achieve 15,000 psi (1,034 bar) with the female threaded fittings used with some of these products, use the P-278 extender tool found on page 50.

VHP MicroTight Unions

Part No.	Description	Threads	Includes	Thru-hole	Swept Volume	Pressure Rating	Qty.
VHP UNIONS FOR CAPILLARY TUBING							
UH-432	VHP Union for 1/32" OD Tubing, PEEK/SST	5/16-24 Coned	(2) PK-112, (2) P-416	0.006" (0.150 mm)	5 nL	15,000 psi (1,034 bar)	ea.
UH-436	VHP Union for 360 µm OD Tubing, PEEK/SST	5/16-24 Coned	(2) PK-152, (2) P-416BLK	0.006" (0.150 mm)	5 nL	15,000 psi (1,034 bar)	ea.
UH-632	VHP True ZDV Union for 1/32" OD Tubing, PEEK/SST	6-32 Coned	(2) PK-126, (1) P-553 Gauge Plug	N/A	N/A	15,000 psi (1,034 bar)	ea.
1959-01	VHP Union for 1/32" OD Tubing, SST	M4x0.7	N/A (Fittings must be ordered separately)	0.007" (178 µm)	16 nL	30,000 psi (2,070 bar)	ea.



MicroTight[®] Adapters

- › Convenient adapters for common 1/16" OD to capillary tubing
- › Direct connect to 1/32" OD or 360 µm OD tubing options available
- › VHP adapters pressure rated to 12,000 psi (828 bar)

NOTE

While many 10-32 coned fittings are interchangeable, coned fittings using different threads are generally not interchangeable. As such, IDEX Health & Science recommends that only the style of coned fittings that accompanies these connectors be used for replacements.

Create a true zero dead volume (ZDV) connection between 1/16" OD tubing and capillary tubing with our MicroTight Adapters.

For Very High Pressure applications the UH-630 will connect 1/16" OD to 1/32" OD tubing in an inline true ZDV connection with the ability to withstand 12,000 psi (828 bar)! The materials of construction also allow this product to be used up to 200 °C, which reduces the pressure rating to 8,000 psi (552 bar). For more information on the fittings used with the VHP adapter, please see page 59.

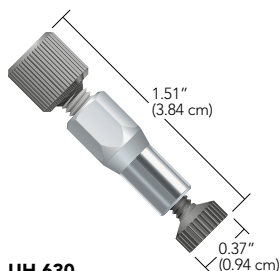

UH-630
VHP MicroTight Adapter for 1/16" and 1/32" OD tubing with fittings included



UH-634
VHP MicroTight Adapter for 1/16" and 360 µm OD tubing with fittings included

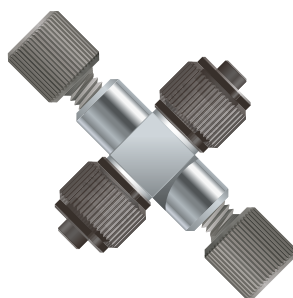

UH-906
VHP MicroTight Adapting Cross 10-32 Coned for 1/16" OD tubing and 5/16-24 Coned for 360 µm OD tubing

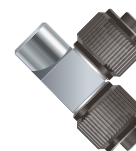

UH-753
VHP MicroTight Adapting Tee 360 µm (2 ports) to 10-32 C for 1/16" OD tubing (1 port)



UH-631-01
VHP MicroTight Adapter 10-32 Coned for 1/16" OD tubing and 6-40 Coned for 1/32" OD tubing fittings not included



1958-01
VHP MicroTight Adapter 10-32 Coned for 1/16" OD tubing and M4x0.7 for 1/32" OD tubing

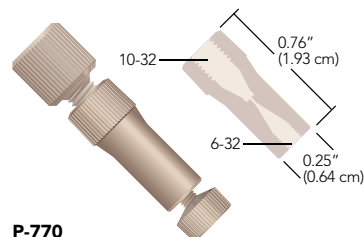

P-770
MicroTight ZDV Adapter for 1/16" OD to MicroTight Sleeves with fittings included

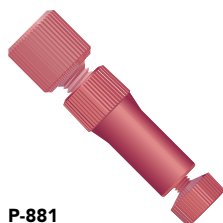

P-881
MicroTight ZDV Adapter for 1/16" to 1/32" OD tubing with fittings included

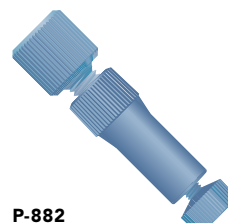

P-882
MicroTight ZDV Adapter for 1/16" to 360 µm OD tubing with fittings included

MicroTight® Adapters (Cont.)



RELATED PRODUCTS

- › Replacement 6-32 fittings are on page 34.
- › Replacement F-120 style nuts are on page 32 (when ordering, replace the “x” with an “R” or “B” to order either red or blue fittings).
- › Use this list to find micro flow products outside this chapter.

	Page
360 µm, 510 µm (0.020”), and 1/32” OD PEEK Tubing	16
360 µm OD Fused Silica Tubing	16
1/16” and 1/32” OD PEEKsil™ Tubing	22
1/32” OD FEP Tubing	26
360 µm OD High Purity PFA Tubing	24
510 µm (0.020”) and 1/32” OD Stainless Steel Tubing	19
Polymer Capillary and Fused Silica Tubing Cutters	28
MX Series II™ Injection and Switching Valves	119
Manual Injection Valves	121
Micro Injection Port Adapters	132
Micro-Splitter Valves	140
Micro-Metering Valves	141
Microbore Guard Column	158
Ultra-Low Volume Back-Pressure Regulators	144
Nonmetallic 10-32 Micro-Volume Inline Check Valve	137

MicroTight® Adapters

Part No.	Description	Threads	Includes	Color	Swept Volume	Pressure Rating	Qty.
MICROTIGHT ADAPTERS							
P-770	PEEK Micro Adapter, True ZDV, for 1/16” OD Tubing to MicroTight Tubing Sleeve	10-32 C to 6-32 C	(1) F-120, (1) F-125, (1) P-554	Natural	N/A	4,000 psi (276 bar)	ea.
P-881	PEEK Micro Adapter, True ZDV, for 1/16” to 1/32” OD Tubing	10-32 C to 6-32 C	(1) F-120R, (1) F-126S, (1) P-554	Red	N/A	5,000 psi (345 bar)	ea.
P-882	PEEK Micro Adapter, True ZDV, for 1/16” to 360 µm OD Tubing	10-32 C to 6-32 C	(1) F-120B, (1) F-124S, (1) P-554	Blue	N/A	5,000 psi (345 bar)	ea.
UH-630	Stainless Steel VHP Micro Adapter, for 1/16” to 1/32” OD Tubing	10-32 C to 6-32 C	(1) PK-120BLK, (1) PK-126, (1) P-554	SST/Black	N/A	12,000 psi (827 bar)	ea.
UH-634	Stainless Steel VHP Micro Adapter, for 1/16” to 360 µm OD Tubing	10-32 C to 6-32 C	(1) PK-120BLK, (1) PK-124, (1) P-554	SST/Black	N/A	12,000 psi (827 bar)	ea.
UH-753	Stainless Steel VHP Micro Adapting Tee, for 1/16” to 360 µm OD Tubing	10-32 C to 5/16-24 C	(2) P-416BLK, (2) PK-152	SST/Black	152 nL	15,000 psi (1,035 bar)*	ea.
1958-01	Stainless Steel VHP Micro Adapter, for 1/16” to 1/32” OD Tubing	10-32 C to M4x0.7 C	N/A	SST	16 nL	30,000 psi (2,070 bar)*	ea.
UH-631-01	Stainless Steel VHP Micro Adapter, for 1/16” to 1/32” OD Tubing	10-32 C to 6-40 C	N/A	SST	13 nL	30,000 psi (2,070 bar)*	ea.
UH-906	Stainless Steel VHP Micro Adapting Cross, for 1/16” to 360 µm OD Tubing	10-32 C to 5/16-24 C	(2) PK-120BLK, (2) P-416BLK, (2) PK-152	SST/Black	0.11 µL	15,000 psi (1,035 bar)*	ea.
REPLACEMENT GAUGE PLUGS (TO ACHIEVE TRUE ZDV CONNECTIONS WITH THE ABOVE ADAPTERS)							
P-554	Delrin® Gauge Plug	10-32 C		White	N/A	N/A	ea.
C = Coned							
* Pressure rating depends upon the fitting used.							



Accessories

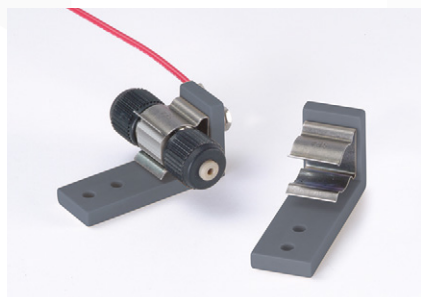

Insulating Mounting Bracket, shown with lead wire and Conductive MicroTight Union, not included.

Insulating Mounting Bracket

Use our Insulating Mounting Bracket to easily integrate the Conductive MicroTight Union (shown on page 71) or our Conductive Mini MicroFilters (on page 109) into your system or lab.

The product snaps into place. Voltage from your lead wire is conducted through the attaching stainless steel nut and screw (included), then onto the mounted product via the stainless steel clip.

The bracket's base includes two holes (#2 screw clearance) for easy mounting onto any lab surface. Dimensions are 1.25" L x 0.45" W x 0.63" H.

Part No.	Description	Threads	Includes	Thru-hole	Swept Volume	Pressure Rating	Qty.
INSULATING MOUNTING BRACKET							
M-447	Insulating Mounting Bracket	N/A	N/A	N/A	N/A	N/A	ea.



NanoPort Assemblies

- › For lab-on-a-chip applications
- › Options to connect 1/16" OD Tubing directly, or 360µm and 1/32" OD Tubing with tubing sleeves
- › **Wetted materials:**
PEEK and perfluoroelastomer

NanoPort Assemblies provide consistent fluid connections for chip-based analyses. NanoPort connections will bond to a variety of substrate materials with the use of Loctite.™

All NanoPort components are made of inert, biocompatible PEEK polymer (nuts and ports), Perlast® perfluoroelastomer (gaskets), and ETFE (ferrules). Their unique design also prevents adhesive contamination of the fluid path. And NanoPort connections add no additional volume to the fluid path, virtually eliminating dead volume traditionally associated with chip-based fluid connections.

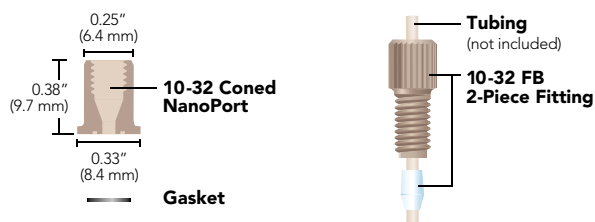

NOTE

Our NanoPort Assembly will readily connect 1/16" OD tubing with the included fittings. To connect 1/32" OD or 360µm OD, tubing sleeves for each size are included in each assembly.

Adhesive is not included in the N-333 NanoPort Assembly. Please contact IDEX Health & Science for bonding information or use common bonding adhesives such as Loctite.

Part No.	Description	Threads	For Chip Hole	Tubing OD	Qty.
NANOPORT ASSEMBLIES					
10-32 Coned NanoPort Assembly					
N-333	F-333N	F-142N	Up to 0.063" (1.6 mm)	1/16"	ea.
NANOPORT REPLACEMENT PARTS					
F-333Nx	Headless Fittings	10-32 C	Up to 0.063" (1.6 mm)	1/16"	10-pk
F-142Nx	Ferrules	10-32 C	Up to 0.063" (1.6 mm)	1/16"	10-pk
Gaskets					
N-123-02	Gasket, For all assemblies except 6-32 Coned Assemblies		N/A	N/A	ea.

Low Pressure Manifolds



Choose a 5, 7, or 9 Port Manifold to combine several streams into one, or split one fluid stream into several. Each PEEK manifold comes complete with 1/4-28 Super Flangeless™ Fittings for either 1/16" or 1/8" OD tubing, with pressure ratings of 2,000 psi (138 bar) and 500 psi (34 bar), respectively.

A few useful applications include:

- › Multiport mixing chamber
- › Gas sparging splitting union
- › Sample injection onto multi-well plates or a multiple direction flow path union

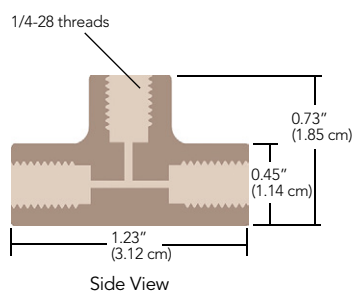

P-150
PEEK 7-Port Manifold
comes with Super Flangeless Fittings

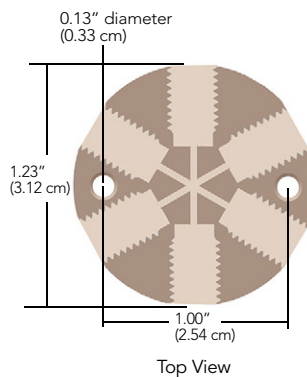

Part No.	Description	Threads	Includes	Thru-hole	Swept Volume	Pressure Rating	Qty.
MANIFOLDS							
Standard							
P-150	PEEK 7-Port Manifold for 1/16" OD Tubing	1/4-28 FB	(7) P-255, (7) P-250	0.040" (1.00 mm)	42.0 µL	1,000 psi (69 bar)	ea.
P-154	PEEK 5-Port Manifold for 1/16" OD Tubing	1/4-28 FB	(5) P-255, (5) P-250	0.040" (1.00 mm)	22.3 µL	1,000 psi (69 bar)	ea.
P-155	PEEK 5-Port Manifold for 1/8" OD Tubing	1/4-28 FB	(5) P-331, (5) P-359	0.062" (1.60 mm)	53.8 µL	500 psi (34 bar)	ea.
P-190	PEEK 9-Port Manifold for 1/8" OD Tubing	1/4-28 FB	(9) P-331, (9) P-359	0.062" (1.60 mm)	160 µL	500 psi (34 bar)	ea.
P-191	PEEK 9-Port Manifold for 1/16" OD Tubing	1/4-28 FB	(9) P-255, (9) P-250	0.040" (1.00 mm)	139 µL	1,000 psi (69 bar)	ea.

FB = Flat Bottom



Low Pressure Bulkhead Unions

- › Designed for plumbing tubing through equipment housing
- › For use with standard 10-32 coned or 1/4-28 flat-bottom threaded fittings

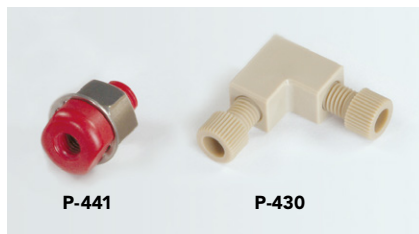
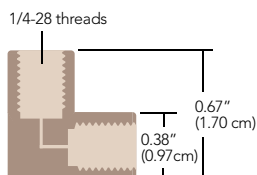
**P-441****P-430****P-430**

PEEK Elbow comes with Flangeless Fittings

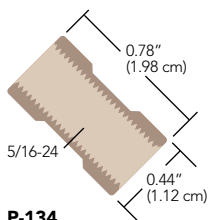
**P-134**

PEEK ZDV Union

Thread PEEK Bulkhead Unions directly through your equipment housing to connect internal tubing to the outside. Each union has unique 3/8-24 external threads and comes complete with a stainless steel nut and lock washer to hold it in place. Requires a 3/8" hole to mount. The recommended torque limit for these unions is 15 in.-lbs (1.7 N-m).

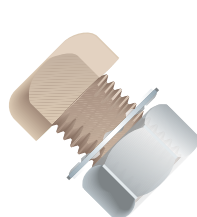
**Bulkhead Union**

includes stainless steel nut/lock washer

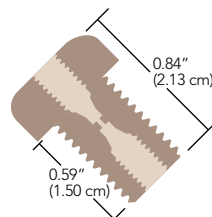
**P-440**

10-32 internal threads

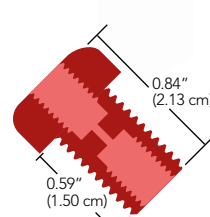
**P-441**

1/4-28 internal threads

Elbow Connectors

Use these Elbow Connectors to easily navigate tight corners. One Elbow is designed for use with 1/16" OD tubing and has a 0.020" (0.50 mm) thru-hole. Use 1/8" OD tubing with the other Elbow, which has a 0.062" (1.6 mm) thru-hole. Both come complete with 1/4-28 PEEK nuts and ETFE ferrules, and are pressure rated to 1,000 psi (69 bar).

Large Bore Union

- › 5/16-24 flat-bottom threads

Use any of the 5/16-24 fittings on page 55 and the appropriate ferrule to create a true zero dead volume (ZDV) connection with the P-134 Union.



RELATED PRODUCTS

- › Stainless Steel Bulkhead Unions are also available. Please contact us for more information.
- › To use Elbows in higher pressure applications, simply replace the provided fittings with Super Flangeless™ Nuts and Ferrules, found on page 39.

Part No.	Description	Threads	Color	Includes	Thru-hole	Swept Volume	Qty.
BULKHEAD UNIONS							
P-440	PEEK Bulkhead Union	10-32 Coned	Natural	(1) SST Nut/Washer	0.020" (0.50 mm)	1.9 µL	ea.
P-441	PEEK Bulkhead Union	1/4-28 Flat-Bottom	Red	(1) SST Nut/Washer	0.040" (1.00 mm)	2.9 µL	ea.
P-441N	PEEK Bulkhead Union	1/4-28 Flat-Bottom	Natural	(1) SST Nut/Washer	0.040" (1.00 mm)	2.9 µL	ea.
ELBOW CONNECTORS							
P-430	PEEK Elbow for 1/16" OD Tubing	1/4-28 Flat-Bottom	Natural	(2) XP-235	0.020" (0.50 mm)	1.4 µL	ea.
P-432	PEEK Elbow for 1/8" OD Tubing	1/4-28 Flat-Bottom	Natural	(2) XP-335	0.062" (1.60 mm)	13.6 µL	ea.
LARGE BORE UNION							
P-134	PEEK True ZDV Union	5/16-24 Flat-Bottom	Natural	N/A	N/A	N/A	ea.



Low Pressure Y Connectors

PEEK Y Connectors are designed to split a stream or join two streams together, just like a tee. However, the configuration of a tee can lead to turbulent flow and solvent outgassing, which increases baseline noise and reduces sensitivity. The geometry of a Y connector creates less turbulence and thus can improve analytical results.

All of these Y Connectors use 1/4-28 Flangeless fittings, except P-515 which uses 5/16-24 fittings (to accommodate larger tubing).

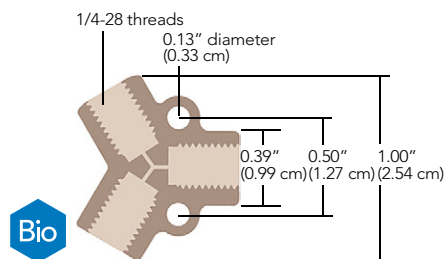

P-512
PEEK Y comes with Flangeless Fittings

Part No.	Description	Threads	Includes	Thru-hole	Swept Volume	Pressure Rating	Qty.
Y CONNECTORS							
P-512	PEEK Y for 1/16" OD Tubing	1/4-28 FB	(3) XP-235	0.020" (0.50 mm)	1.7 μ L	1,000 psi (69 bar)	ea.
P-513	PEEK Y for 1/8" OD Tubing	1/4-28 FB	(3) XP-335	0.040" (1.00 mm)	6.0 μ L	500 psi (34 bar)	ea.
P-514	PEEK Y for 1/8" OD Tubing	1/4-28 FB	(3) XP-335	0.060" (1.50 mm)	13.6 μ L	500 psi (34 bar)	ea.
P-515	PEEK Y for 3/16" OD Tubing	5/16-24 FB	(3) XP-132	0.125" (3.20 mm)	47.7 μ L	500 psi (34 bar)	ea.

FB = Flat-Bottom



- › Manufactured from PEEK, ETFE, Delrin®, polypropylene, or PCTFE
- › Available with 1/4-28, M6, or 10-32 flat-bottom threads

Low Pressure Unions

Our Low Pressure Unions are available in a variety of polymers, providing several low-cost and chemically-resistant options. The union assemblies below include fittings as shown in the table. The unions in the right column do not include fittings, allowing for customizing the fitting selection. In some cases, a union can be configured to connect two different tubing sizes—for example, if 1/4-28 Flangeless fittings for 1/16" and 1/8" OD tubing were selected from page 45 they can be used with the P-603 union to connect the two different tubing sizes.

Low Pressure PEEK Union Assemblies

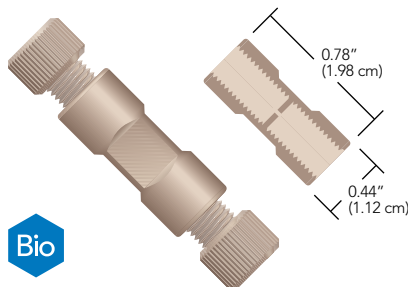

P-702 & P-703
PEEK Unions with Flangeless Fittings
(1/4-28 internal threads)

Low Pressure ETFE Union Assemblies

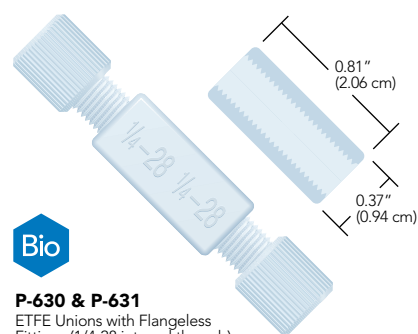

P-630 & P-631
ETFE Unions with Flangeless Fittings
(1/4-28 internal threads)

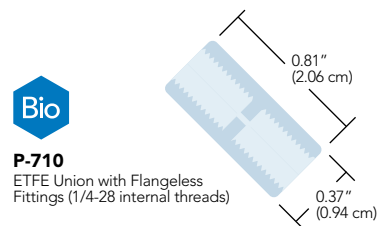

P-710
ETFE Union with Flangeless Fittings
(1/4-28 internal threads)

Low Pressure Standard Unions

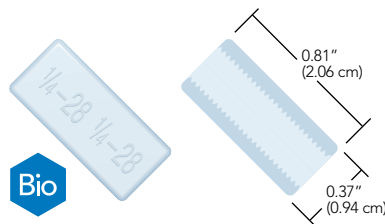

P-603, P-620 & P-623
Standard Unions (1/4-28 internal threads)

Low Pressure Metric Unions

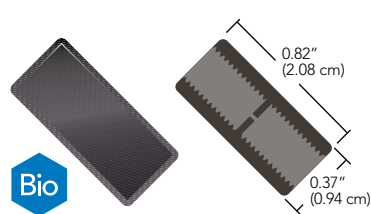

P-602 & P-622
Metric Unions (M6 internal threads)

Low Pressure Male Union

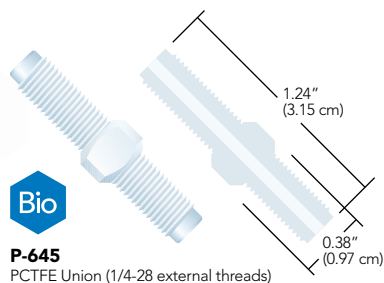

VacuTight™ Union

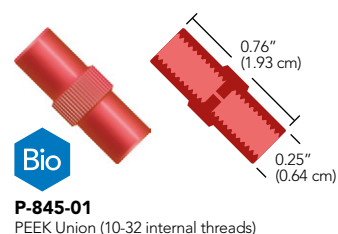

RELATED PRODUCTS

- › To use connectors in higher pressure applications, simply replace the provided fittings with Super Flangeless™ Nuts and Ferrules, found on page 39.
- › Use any of the 10-32 flat-bottom fittings on 39 and 42 to make an inline connection with our VacuTight Union. This product is designed for use with 1/16" OD tubing.

Low Pressure Unions

Part No.	Description	Color	Threads	Includes	Thru-hole	Swept Volume	Pressure Rating	Qty.
PEEK UNION ASSEMBLIES								
P-702	PEEK Union for 1/16" OD Tubing	Natural	1/4-28 FB	(2) XP-235	0.020" (0.50 mm)	0.41 µL	1,000 psi (69 bar)	ea.
P-703	PEEK Union for 1/8" OD Tubing	Natural	1/4-28 FB	(2) XP-335	0.050" (1.25 mm)	2.57 µL	1,000 psi (69 bar)	ea.
ETFE UNION ASSEMBLIES								
P-630	ETFE True ZDV Union for 1/16" OD Tubing	Natural	1/4-28 FB	(2) P-200N/P-245	N/A	N/A	1,000 psi (69 bar)	ea.
P-631	ETFE True ZDV Union for 1/8" OD Tubing	Natural	1/4-28 FB	(2) P-300N/P-345	N/A	N/A	1,000 psi (69 bar)	ea.
P-710	ETFE Union for 1/16" OD Tubing	Natural	1/4-28 FB	(2) XP-245	0.030" (0.75 mm)	0.93 µL	1,000 psi (69 bar)	ea.
STANDARD UNIONS								
P-603	Delrin True ZDV Standard Union	Natural	1/4-28 FB	N/A	N/A	N/A	N/A*	ea.
P-620	Polypropylene True ZDV Standard Union	Natural	1/4-28 FB	N/A	N/A	N/A	N/A*	ea.
P-623	ETFE True ZDV Standard Union	Natural	1/4-28 FB	N/A	N/A	N/A	N/A*	ea.
METRIC UNIONS								
P-602	Delrin Metric Union	Black	M6 FB	N/A	0.020" (0.50 mm)	0.41 µL	N/A*	ea.
P-622	ETFE Metric Union	Blue	M6 FB	N/A	0.020" (0.50 mm)	0.41 µL	N/A*	ea.
MALE UNION								
P-645	PCTFE Male Union	Natural	1/4-28 FB	N/A	0.062" (1.60 mm)	61.3 µL	500 psi (34 bar)	ea.
VACUTIGHT UNION								
P-845-01	PEEK Union for 1/16" OD Tubing	Red	10-32 FB	N/A	0.020" (0.50 mm)	0.20 µL	N/A*	ea.

* Pressure Rating depends on Fittings selected. See pressure rating for fittings on appropriate page.
FB = Flat-Bottom

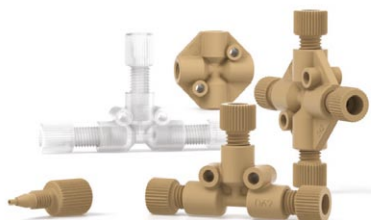

Low Pressure Tees & Crosses

Our Low Pressure Tees and Crosses are available in two inert polymers and can handle pressures to 500 psi (34 bar) or 1,000 psi (69 bar), depending upon the configuration of the products. Each is designed with handy mounting holes. All ETFE Tees and Crosses ship complete with 1/4-28 PFA Flangeless nuts and ETFE ferrules, while their PEEK polymer counterparts ship with 1/4-28 PEEK nuts and ETFE ferrules. Replacement fittings are located on page 47.

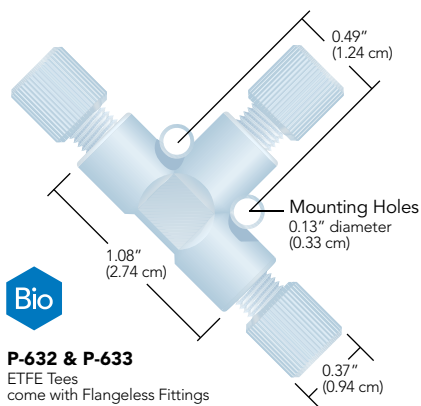

Bio

P-632 & P-633
ETFE Tees
come with Flangeless Fittings

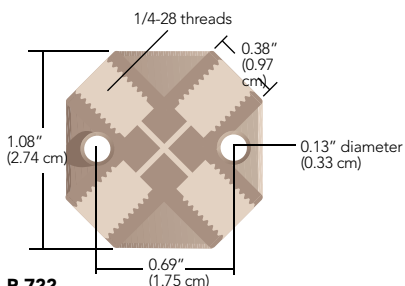

P-722
PEEK Cross
comes with Flangeless Fittings

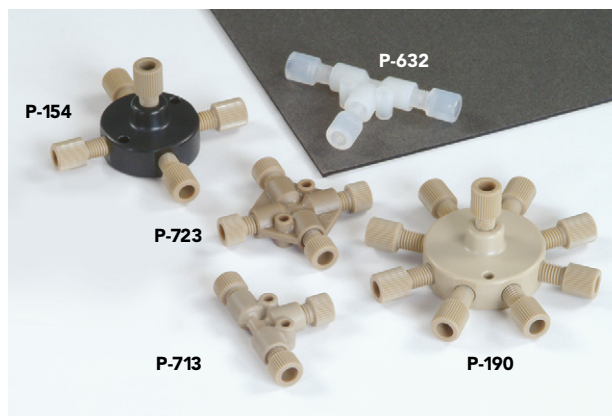

RELATED PRODUCTS

- › Seal off unused ports with any of our 1/4-28 flat-bottom plugs found on page 55.
- › To use the PEEK polymer versions of our Tees and Crosses in higher pressure applications, simply replace the provided fittings with Super Flangeless™ Nuts and Ferrules, found on page 39.
- › High Pressure Tees, Crosses, and a 7-Port Manifold (all with 10-32 threaded ports) are on page 74.

NOTE

- › To order just the body of one of our tees and crosses without fittings, simply add a '-01' to the part number — e.g., P-632-01.

Part No.	Description	Threads	Includes	Thru-hole	Swept Volume	Pressure Rating	Qty.
LOW PRESSURE TEES AND CROSSES							
P-632	ETFE Tee for 1/16" OD Tubing	1/4-28 Flat-Bottom	(3) P-245, (3) P-200N	0.020" (0.50 mm)	2.9 µL	1,000 psi (69 bar)	ea.
P-633	ETFE Tee for 1/8" OD Tubing	1/4-28 Flat-Bottom	(3) P-345, (3) P-300N	0.050" (1.25 mm)	17.5 µL	500 psi (34 bar)	ea.
P-634	ETFE Cross for 1/16" OD Tubing	1/4-28 Flat-Bottom	(4) P-245, (4) P-200N	0.020" (0.50 mm)	3.8 µL	1,000 psi (69 bar)	ea.
P-635	ETFE Cross for 1/8" OD Tubing	1/4-28 Flat-Bottom	(4) P-345, (4) P-300N	0.050" (1.25 mm)	22.8 µL	500 psi (34 bar)	ea.
P-712	PEEK Tee for 1/16" OD Tubing	1/4-28 Flat-Bottom	(3) XP-235	0.020" (0.50 mm)	2.9 µL	1,000 psi (69 bar)	ea.
P-713	PEEK Tee for 1/8" OD Tubing	1/4-28 Flat-Bottom	(3) XP-335	0.050" (1.25 mm)	17.5 µL	500 psi (34 bar)	ea.
P-714	PEEK Tee for 1/16" OD Tubing	1/4-28 Flat-Bottom	(3) XP-235	0.040" (1.00 mm)	11.4 µL	1,000 psi (69 bar)	ea.
P-722	PEEK Cross for 1/16" OD Tubing	1/4-28 Flat-Bottom	(4) XP-235	0.020" (0.50 mm)	3.8 µL	1,000 psi (69 bar)	ea.
P-723	PEEK Cross for 1/8" OD Tubing	1/4-28 Flat-Bottom	(4) XP-335	0.050" (1.25 mm)	22.8 µL	500 psi (34 bar)	ea.



Quick Connect Luer Adapters

- › Delrin®, polypropylene, ETFE, or PEEK Versions
- › Adapts luers to 1/4-28, 10-32, 5/16-24, or M6 threaded ports

These luer adapters were designed to work in a variety of applications. By connecting any male luer to any female luer, you can create your own quick connect union or adapter. Each Quick Connect Luer Adapter conforms to ISO requirements for medical luer taper configuration and performance (45 psi/3.1 bar).

Find fittings to connect tubing to the threaded ports of these adapters in the Fittings chapter, starting on page 30.

Please Note: Our Female Quick Connect Luer Adapters can be used with any of the Male Luers on this page, i.e., those with and without lock hubs.



APPLICATION NOTE

- › Our A-626 Bottle Cap Plug (page 55) can be used to plug any of the female luer adapters on this page.
- › To prevent a chemical spill when disconnecting your solvent reservoir tubing from the pump, try our Quick-Stop Luer Check Valve on page 139.
- › To economically prime an HPLC pump, simply remove the 10-32 fitting on the outlet check valve (standard on most models), insert a P-642 luer adapter, attach a syringe (such as our B-310) and draw the mobile phase through the pump head.

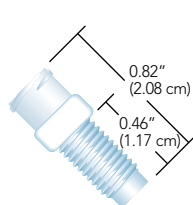

P-604, P-618, P-624
Female Luer to 1/4-28 Male
(luer end of P-604 different than shown)

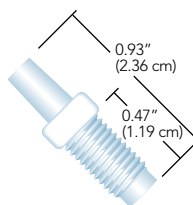

P-619, P-625
Male Luer to 1/4-28 Male

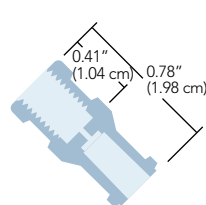

P-628
Female Luer to 1/4-28 Female

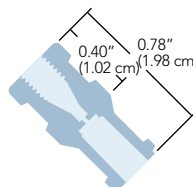

P-629
Female Luer to 10-32 Female

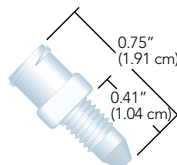

P-642
Female Luer to 10-32 Male

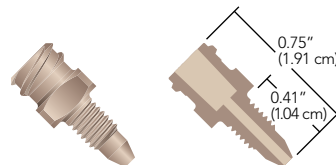

P-719
Female Luer to 10-32 Male

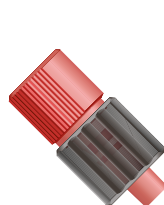

P-655, P-675
Male Luer to 1/4-28 Female

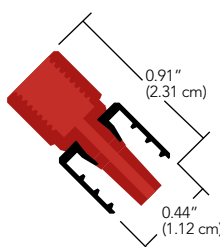

P-656
Male Luer to 10-32 Female

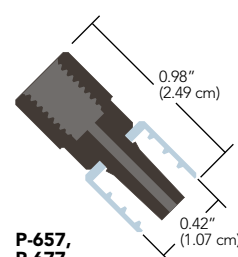

P-657, P-677
Male Luer to M6 Female

Quick Connect Luer Adapters (Cont.)

Luer-To-MicroTight® Adapter

› Easily connect 360 µm OD tubing to a syringe



P-662 Luer-to-MicroTight Adapter, shown with a B-310 Syringe (see table below) and PEEK capillary tubing (page 16), not included.

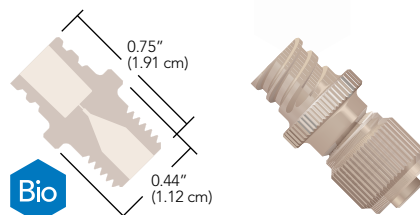

P-662
Luer-To-MicroTight Adapter for Luer to 360 µm OD tubing with fittings included

Quick Connect Luer Adapters

Part No.	Description	Body Material	Lock Hub Material	Thru-hole	Qty.
QUICK CONNECT LUER ADAPTERS					
P-604	F Luer to 1/4-28 FB, M	Nat. Delrin	N/A	0.05" (1.3 mm)	ea.
P-618	F Luer to 1/4-28 FB, M	Nat. PP	N/A	0.05" (1.3 mm)	ea.
P-619	M Luer to 1/4-28 FB, M	Nat. PP	None *	0.05" (1.3 mm)	ea.
P-624	F Luer to 1/4-28 FB, M	Nat. ETFE	N/A	0.05" (1.3 mm)	ea.
P-625	M Luer to 1/4-28 FB, M	Nat. ETFE	None *	0.04" (1.0 mm)	ea.
P-628	F Luer to 1/4-28 FB, F	Nat. ETFE	N/A	0.04" (1.0 mm)	ea.
P-629	F Luer to 10-32 C, F	Nat. ETFE	N/A	0.04" (1.0 mm)	ea.
P-642	F Luer to 10-32 C, M	Nat. ETFE	N/A	0.05" (1.3 mm)	ea.
P-655	M Luer to 1/4-28 FB, F	Red PEEK	Black PEEK	0.04" (1.3 mm)	ea.
P-656	M Luer to 10-32 C, F	Nat. PEEK	Black PEEK	0.05" (1.3 mm)	ea.
P-657	M Luer to M6 FB, F	Black PEEK	Black PEEK	0.05" (1.3 mm)	ea.
P-658	F Luer to 1/4-28 FB, F	Red PEEK	N/A	0.05" (1.3 mm)	ea.
P-659	F Luer to 10-32 C, F	Nat. PEEK	N/A	0.05" (1.3 mm)	ea.
P-660	F Luer to M6 FB, F	Black PEEK	N/A	0.05" (1.3 mm)	ea.
P-661	F Luer to 5/16-24 FB, M	Nat. ETFE	N/A	0.05" (1.3 mm)	ea.
P-675	M Luer to 1/4-28 FB, F	Red ETFE	Natural PP	0.05" (1.3 mm)	ea.
P-677	M Luer to M6 FB, F	Black ETFE	Natural PP	0.05" (1.3 mm)	ea.
P-678	F Luer to 1/4-28 FB, F	Red ETFE	N/A	0.05" (1.3 mm)	ea.
P-680	F Luer to M6 FB, F	Black ETFE	N/A	0.05" (1.3 mm)	ea.
P-683	M Luer to 1/4-28 FB, M	Nat. PEEK	Black PEEK	0.04" (1.0 mm)	ea.
P-686	F Luer to M6 FB, M	Black ETFE	N/A	0.05" (1.3 mm)	ea.
P-719	F Luer to 10-32 C, M	Nat. PEEK	N/A	0.05" (1.3 mm)	ea.
SYRINGE WITH MALE LUER LOCK					
B-310	10 cc Disposable Luer-Lock Syringe. For use with any Female Luer Adapter			0.05" (1.3 mm)	ea.
LUER-TO-MICROTIGHT ADAPTER					
P-662	Luer-to-MicroTight Adapter	(1) F-152, (1) P-416	0.006" (0.150 mm)	45 psi (2.4 bar)	ea.

F = Female (internal) threads; M = Male (external) threads; Nat. = Natural; N/A = Not Applicable;
PP = Polypropylene; FB = Flat-Bottom; C = Coned
* Slip-type male luer.



LuerTight[™] Fittings

- › Luer fittings for fluoropolymer tubing
- › Quick disconnect and barbless
- › For 1/16" and 1/8" OD tubing

Our LuerTight fittings are specifically designed to connect fluoropolymer tubing without barbs or nuts! By integrating ferrules into the luer bodies, LuerTights will reliably hold your tubing in place while giving you the convenience of a luer connection. An inline set of LuerTight fittings provides a quick and easy disconnection option. LuerTight connections are also less bulky and more economical than nut-to-luer style fittings.

The bodies of these products are manufactured from polypropylene and the ferrules, where used, are made of ETFE.

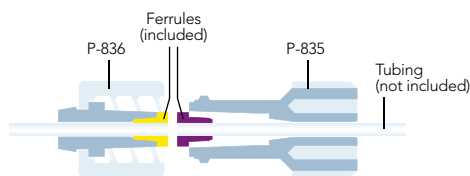

P-837
LuerTight Fittings System for 1/16" OD tubing

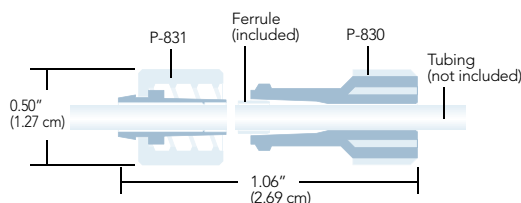

P-838
LuerTight Fittings System for 1/8" OD tubing



NOTE

LuerTight fittings are designed to be used exclusively within the LuerTight family. Combining LuerTight fittings with non-LuerTight luer products may result in a poor connection.

Part No.	Description	Includes	Thru-hole	Pressure Rating	Qty.
LUERTIGHT FITTINGS SYSTEMS					
P-837	LuerTight System for 1/16" OD Tubing	(1) P-835, (1) P-836, (1) P-830T	N/A	100 psi (7 bar)	ea.
P-838	LuerTight System for 1/8" OD Tubing	(1) P-830, (1) P-831, (1) P-830T	N/A	100 psi (7 bar)	ea.
LUERTIGHT FITTING COMPONENTS					
P-830	Female Fitting for 1/8" OD Tubing	(1) Ferrule	N/A	N/A	ea.
P-830T	Set Plug to swage Ferrules into P-835 and P-830	N/A	N/A	N/A	ea.
P-831	Male Fitting for 1/8" OD Tubing	No Ferrule Required	N/A	N/A	ea.
P-835	Female Fitting for 1/16" OD Tubing	(1) Ferrule	N/A	N/A	ea.
P-836	Male Fitting for 1/16" OD Tubing	(1) Ferrule	N/A	N/A	ea.

Female = internal receiving luer pocket; Male = external luer nose (surrounded by internally-threaded locking ring)



Barbed Connectors

Our Type 1 Barbed Unions have been engineered to effectively join two pieces of soft-walled tubing together. This type of connector is typically the connector of choice for joining two peristaltic tubes with similar inner diameters together. Our unions are manufactured from either polypropylene or nylon.

Barbed to Barbed Adapters

- › Adapters on this page feature various luer to barb adaptations
- › Adapters on the next page feature a variety of barb-to-barb connectors

Use these barbed adapters to connect peristaltic-type flexible tubing for general, low pressure applications. The polypropylene used to manufacture the majority of these products is a Class VI material. Due to the low melt point of polypropylene (PP), these adapters are not autoclavable, however, they can be sterilized via gamma radiation. There are also Barb to Female Luer-Lock connectors available from ETFE, which has superior solvent resistance and a higher temperature rating (80 °C).

Barbed "Y" Adapters

Our Barbed "Y" Adapters, manufactured from polypropylene, are engineered to effectively join three pieces of soft-walled tubing together in a Y configuration, offering less turbulence and gentler mixing of fluids than a traditional Tee Connector. This type of connector works well for joining three peristaltic tubes with similar inner diameters together.

Thread to Barbed Adapters

- › Three barb sizes, for 1/16", 1/8", and 3/16" ID flexible tubing
- › Adapt to 1/4-28 flat-bottom, 5/16-24 flat-bottom, or 10-32 coned receiving ports

These adapters make it easy to connect flexible tubing to any standard 1/4-28 flat-bottom or 10-32 coned receiving port. Simply thread the adapter into a receiving port and slip tubing over the barbed stem to create a reliable low pressure connection.

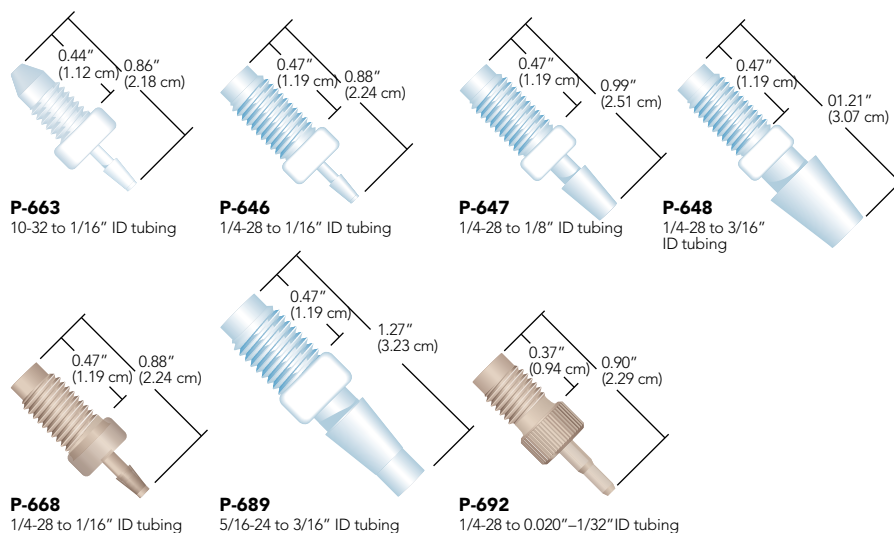



Swivel Barb Adapters

- › Barb connection spins freely from the nut to prevent twist during installation
- › Manufactured from polypropylene

The Swivel Barb Adapters from IDEX Health & Science are made up of two captive pieces acting as a one-piece fitting for ease of use. Manufactured from polypropylene and available in three barb sizes, the Swivel Barb will facilitate connection between flexible tubing to a 1/4-28 flat-bottom port. The barbed insert spins freely from the threaded nut in order to prevent the tubing from twisting during installation.

RELATED PRODUCTS

- › To connect low pressure fluoropolymer tubing, try the LuerTight™ Adapters on page 89.
- › To connect peristaltic tubing to low pressure fluoropolymer tubing, see page 92.
- › For peristaltic tubing, see page 15.

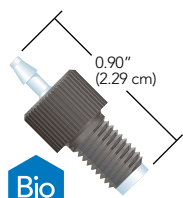

D-646
1/4-28 to 1/16" ID tubing

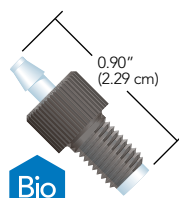

D-647
1/4-28 to 3/32" ID tubing

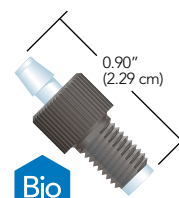

D-648
1/4-28 to 1/8" ID tubing



Luer to Barbed Adapters

Our Luer to Barbed Adapters are an excellent choice when connecting between soft-walled tubing and luer-based products, such as a syringe or a low-pressure filter, for example. We offer several different configurations, allowing you to connect various sizes of soft-walled tubing to receiving ports that accept a male luer "slip" style connection; a male luer "lock" style connection; and a female-luer style of connector.

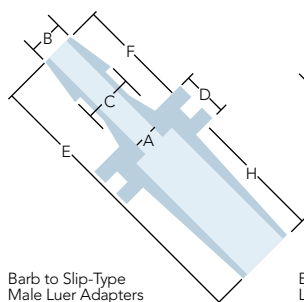

Barb to Slip-Type
Male Luer Adapters

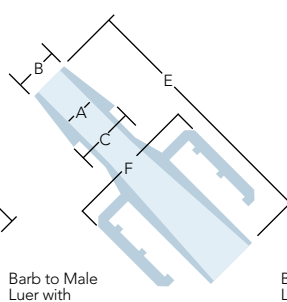

Barb to Male
Luer with
Lock Ring Adapters

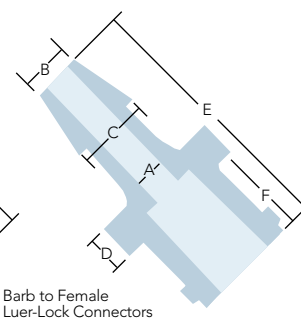

Barb to Female
Luer-Lock Connectors

Barbed Connectors (Cont.)



Conical Adapters

- › Direct connect 1/16" and 1/8" OD rigid and semi-rigid tubing to peristaltic tubing
- › Accept 0.020"–1/8" (0.50–3.2 mm) ID peristaltic tubing
- › Biocompatible flow path with excellent chemical compatibility

Conical Adapters provide a reliable connection between rigid/semi-rigid tubing and peristaltic-type flexible tubing, such as Tygon® and PharMed®. These adapters are composed of a PEEK polymer female nut, our Super Flangeless™ ferrule system and an ETFE or PEEK conical adapter body. The narrow coned end of the adapter body allows peristaltic tubing to slide on more easily than it does onto conventional barbed adapters. Peristaltic tubing is also easier to remove from our Conical Adapters, since no cutting or excessive pulling is required.



APPLICATION NOTE

To help secure peristaltic tubing more firmly to the Conical Adapters, simply attach a cable tie to the outside of the peristaltic tubing once it has been placed onto the Adapter body.

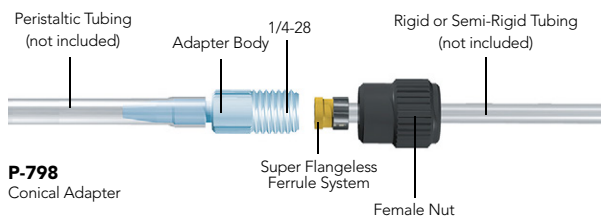
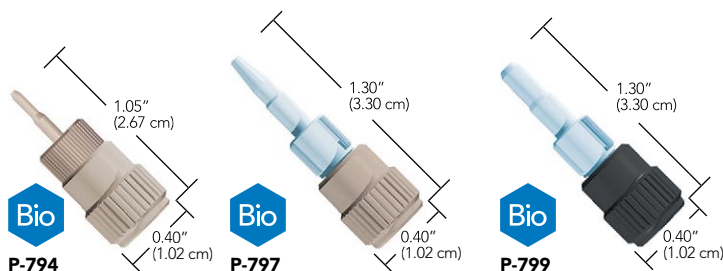

Peristaltic Tubing Adapters

These unique adapters connect peristaltic tubing to standard 1/16" or 1/8" OD tubing. A specially-designed nose allows the peristaltic tubing to simply press fit over the nose and then be held tightly in place by the retainer sleeve. Your 1/16" OD tubing may then be connected with the Flangeless Fittings supplied with the adapter. To connect your peristaltic tubing to tubing with a different OD, simply replace the supplied fittings with your choice of Flangeless Fittings from page 45.

One popular application for these adapters is to use them as "stops" for your peristaltic pump. By doing so, you can reduce the amount of peristaltic tubing required for your flow path, thus reducing cost.

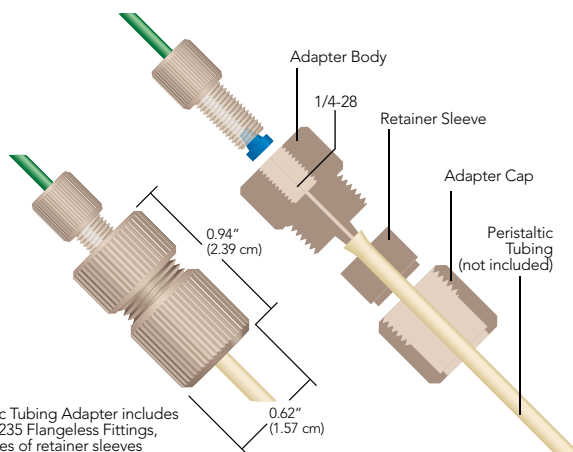

Barbed Connectors

Part No.	Tubing ID	Material	Qty.		
BARBED TO BARBED ADAPTERS					
P-801	0.06" (1.5 mm)	Polypropylene	ea.		
P-802	0.12" (3.0 mm)	Polypropylene	ea.		
BARBED "Y" CONNECTORS					
P-860	0.06" (1.5 mm)	Polypropylene	ea.		
P-861	0.10" (2.5 mm)	Polypropylene	ea.		
P-862	0.12" (3.0 mm)	Polypropylene	ea.		
P-863	0.18" (4.8 mm)	Polypropylene	ea.		
P-864	0.25" (6.4 mm)	Polypropylene	ea.		
THREAD TO BARBED ADAPTERS					
Part No.	Description	Material	Threads	Thru-hole	Qty.
P-663	Barb Adapter, 1/16" (1.55 mm) ID Tubing	ETFE	10-32 Coned	0.04" (1.0 mm)	ea.
P-646	Barb Adapter, 1/16" (1.55 mm) ID Tubing	ETFE	1/4-28 Flat-Bottom	0.04" (1.0 mm)	ea.
P-647	Barb Adapter, 1/8" (3.20 mm) ID Tubing	ETFE	1/4-28 Flat-Bottom	0.08" (2.0 mm)	ea.
P-648	Barb Adapter, 3/16" (4.75 mm) ID Tubing	ETFE	1/4-28 Flat-Bottom	0.10" (2.5 mm)	ea.
P-668	Barb Adapter, 1/16" (1.55 mm) ID Tubing	PEEK	1/4-28 Flat-Bottom	0.04" (1.0 mm)	ea.
P-689	Barb Adapter, 3/16" (4.75 mm) ID Tubing	ETFE	5/16-24 Flat-Bottom	0.10" (2.5 mm)	ea.
P-692	Barb Adapter, 0.020" to 1/32" (0.50 to 0.80 mm) ID Tubing	PEEK	1/4-28 Flat-Bottom	0.02" (0.5 mm)	ea.
SWIVEL BARB ADAPTERS					
D-646	Swivel Barb Adapter, 1/16" (1.55 mm) ID Tubing	Polypropylene	1/4-28 Flat-Bottom	0.03" (0.75 mm)	ea.
D-647	Swivel Barb Adapter, 3/32" (2.40 mm) ID Tubing	Polypropylene	1/4-28 Flat-Bottom	0.056" (1.5 mm)	ea.
D-648	Swivel Barb Adapter, 1/8" (3.20 mm) ID Tubing	Polypropylene	1/4-28 Flat-Bottom	0.08" (2.0 mm)	ea.
BARB TO SLIP-TYPE MALE LUER ADAPTERS					
Part No.	Description	Material	Qty.		
P-854	Male Luers (Slip-type) for use with 1/16" ID (1.55 mm) Tubing A=0.046" B=0.064" C=0.090" D=0.129" E=0.711" F=0.198" H=0.384"	PP	ea.		
<i>These slip-type male luer fittings are for use in systems for which luer lock rings are not desired.</i>					
BARB TO MALE LUER WITH LOCK RING ADAPTERS					
P-850	Male Luers with Lock Ring for use with 1/16" ID (1.55 mm) Tubing A=0.049" B=0.065" C=0.090" E=0.583" F=0.434"	PP	ea.		
P-851	Male Luers with Lock Ring for use with 3/32" ID (2.40 mm) Tubing A=0.071" B=0.100" C=0.139" E=0.681" F=0.436"	PP	ea.		
P-852	Male Luers with Lock Ring for use with 1/8" ID (3.20 mm) Tubing A=0.099" B=0.132" C=0.184" E=0.777" F=0.436"	PP	ea.		
BARB TO FEMALE LUER-LOCK CONNECTORS					
P-857	Female Luer Connectors for use with 1/16" ID (1.55 mm) Tubing A=0.030" B=0.063" C=0.106" D=0.100" E=0.598" F=0.253"	PP	ea.		
P-858	Female Luer Connectors for use with 3/32" ID (2.40 mm) Tubing A=0.056" B=0.102" C=0.145" D=0.100" E=0.648" F=0.253"	PP	ea.		
P-859	Female Luer Connectors for use with 1/8" ID (3.20 mm) Tubing A=0.080" B=0.135" C=0.187" D=0.100" E=0.733" F=0.253"	PP	ea.		
P-870	For use with 1/16" (1.55 mm) ID Tubing A=0.030" B=0.063" C=0.106" D=0.100" E=0.598" F=0.253"	ETFE	ea.		
P-872	For use with 1/8" (3.20 mm) ID Tubing A=0.080" B=0.137" C=0.187" D=0.100" E=0.733" F=0.253"	ETFE	ea.		
PERISTALTIC TUBING ADAPTERS					
Part No.	Description	Tubing OD	Peristaltic Tubing ID	Thru-Hole	Qty.
P-757	Standard Adapter	up to 0.180" (4.55 mm)	0.048"–0.110" (1.20–2.80 mm)	0.030" (0.75 mm)	ea.
P-767	Large Bore Adapter	up to 0.250" (6.35 mm)	0.100"–0.150" (2.55–3.80 mm)	0.070" (1.78 mm)	ea.
CONICAL ADAPTER ASSEMBLIES					
Part No.	Description	Rigid or Semi-Rigid Tubing OD	Peristaltic Tubing ID	Thru-Hole	Qty.
P-794	Conical Adapter	1/16"	0.020"–0.030" (0.50 mm–0.75 mm)	0.020" (0.50 mm)	ea.
P-797	Conical Adapter	1/16"	1/16"–3/32" (1.55 mm–2.40 mm)	0.040" (1.0 mm)	ea.
P-798	Conical Adapter	1/8"	1/16"–3/32" (1.55 mm–2.40 mm)	0.040" (1.0 mm)	ea.
P-799	Conical Adapter	1/8"	3/32"–1/8" (2.40 mm–3.20 mm)	0.060" (1.5 mm)	ea.
CONICAL ADAPTER REPLACEMENT PARTS					
Part No.	Description	For Use With	Material	Qty.	
F-156	Female Nut, 1/8", 1/4-28	P-798, P-799	Black PEEK	ea.	
P-420	Female Nut, 1/16", 1/4-28	P-794, P-797	Natural PEEK	ea.	
P-259	Super Flangeless Ferrule, 1/16"	P-794, P-797	Yellow ETFE/SST	ea.	
P-359	Super Flangeless Ferrule, 1/8"	P-798, P-799	Yellow ETFE/SST	ea.	
P-691	Conical Adapter Body	P-799	Natural ETFE	ea.	
P-692	Conical Adapter Body	P-794	Natural PEEK	ea.	



FILTERS & FRITS

Our Filters offer an optimal way to filter your solvents, preventing pump cavitation and system damage. We offer different style filters for specific system specifications. Our filters protect your system from particulate matter from the solvent that may otherwise damage expensive hardware.

We offer a complete line of Frits manufactured from two different materials: PEEK and stainless steel. Both materials offer a variety of sizes of frit discs, as well as being available in numerous porosities. All our frits are designed with exceptional uniform porosity and a long filtration life.

- 95** FRITS
- 100** FILTERS
- 111** BOTTLE CAPS & PLUGS



Stainless Steel Frits

Our Analytical-scale 316 Stainless Steel Frits are available in 0.5 μm or 2 μm porosity—the most common HPLC filtration ratings. Each frit includes a PCTFE or PEEK polymer sealing ring.

Many of the frits shown have the common 0.250" (0.64 cm) and 0.254" (0.64 cm) ODs, which allow them to be used in many of the Precolumn and Inline Filters found starting on page 103. Choose the larger diameter faces and/or larger porosity frits for faster flow rates. Choose frits with a smaller diameter face and/or smaller porosity for applications sensitive to extra flow path volume.

APPLICATION NOTE

To Clean Or Not To Clean?

It is rarely worth the time and effort to clean frits, given the relatively low cost of replacements. Furthermore, cleaning may leave some debris embedded in the frit pores. If the washed frit is accidentally returned to your instrument in a reverse orientation, any remaining debris could be flushed out and deposited further down the fluid path. If this frit is being used as a column head frit, the debris may be washed directly onto the column bed.

NOTE

Frits without the polymer rings cannot be used with our standard Precolumn and Inline Filter assemblies.

0.5 μm Stainless Steel Frits

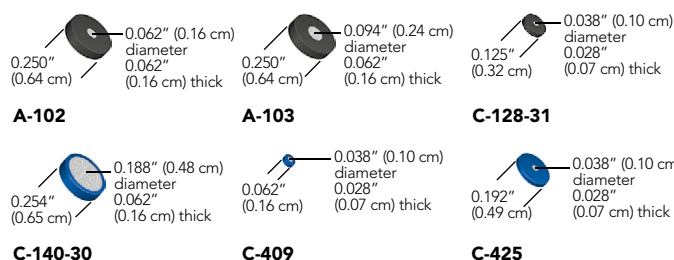

2 μm Stainless Steel Frits

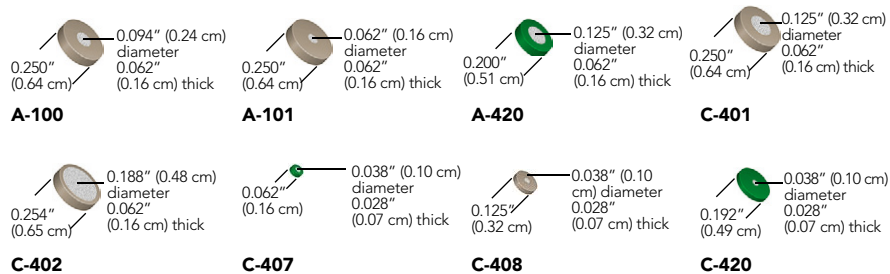

Semi-Prep Stainless Steel Frits

Many of these frits come complete with a PCTFE, ETFE, or PTFE sealing ring. Choose from 2 μm , 5 μm , 10 μm , and 20 μm filtration porosities and a range of diameters to match your intended flow rate and filtration requirements.

2 μm Semi-Prep Stainless Steel Frits

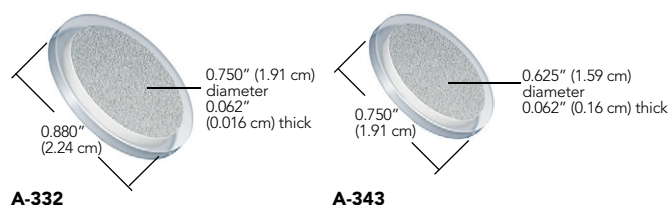

Stainless Steel Frits (Cont.)

5 µm Semi-Prep Stainless Steel Frits

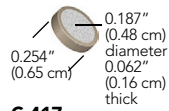

C-417

10 µm Semi-Prep Stainless Steel Frits

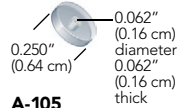

A-105

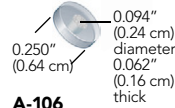

A-106

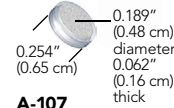

A-107

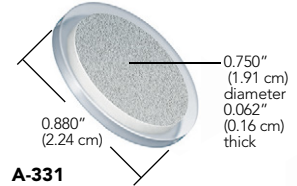

A-331

20 µm Semi-Prep Stainless Steel Frits

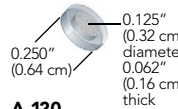

A-120

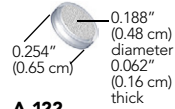

A-122

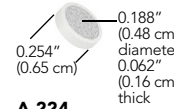

A-224

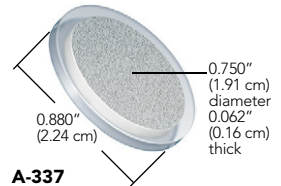

A-337

Stainless Steel Frits

Part No.	Porosity	Disc Diameter	Disc Thickness	Ring OD	Ring Material	Frit Volume	Qty.
STAINLESS STEEL FRITS							
A-100	2 µm	0.094" (0.24 cm)	0.062" (0.16 cm)	0.250" (0.64 cm)	PEEK	1.7 µL	ea.
A-101	2 µm	0.062" (0.16 cm)	0.062" (0.16 cm)	0.250" (0.64 cm)	PEEK	0.7 µL	ea.
A-102	0.5 µm	0.062" (0.16 cm)	0.062" (0.16 cm)	0.250" (0.64 cm)	PEEK	0.6 µL	ea.
A-103	0.5 µm	0.094" (0.24 cm)	0.062" (0.16 cm)	0.250" (0.64 cm)	PEEK	1.4 µL	ea.
A-420	2 µm	0.125" (0.32 cm)	0.062" (0.16 cm)	0.200" (0.51 cm)	PCTFE	3.0 µL	ea.
C-128-31	0.5 µm	0.038" (0.10 cm)	0.028" (0.07 cm)	0.125" (0.32 cm)	PEEK	0.1 µL	ea.
C-140-30	0.5 µm	0.188" (0.48 cm)	0.062" (0.16 cm)	0.254" (0.65 cm)	PCTFE	6.5 µL	ea.
C-401	2 µm	0.125" (0.32 cm)	0.062" (0.16 cm)	0.250" (0.64 cm)	PEEK	3.0 µL	ea.
C-402	2 µm	0.188" (0.48 cm)	0.062" (0.16 cm)	0.254" (0.65 cm)	PEEK	7.8 µL	ea.
C-407	2 µm	0.038" (0.10 cm)	0.028" (0.07 cm)	0.062" (0.16 cm)	PCTFE	0.1 µL	ea.
C-408	2 µm	0.038" (0.10 cm)	0.028" (0.07 cm)	0.125" (0.32 cm)	PEEK	0.1 µL	ea.
C-409	0.5 µm	0.038" (0.10 cm)	0.028" (0.07 cm)	0.062" (0.16 cm)	PCTFE	0.1 µL	ea.
C-420	2 µm	0.038" (0.10 cm)	0.028" (0.07 cm)	0.192" (0.49 cm)	PCTFE	0.1 µL	ea.
C-425	0.5 µm	0.038" (0.10 cm)	0.028" (0.07 cm)	0.192" (0.49 cm)	PCTFE	0.1 µL	ea.
SEMI-PREP STAINLESS STEEL FRITS							
A-105	10 µm	0.062" (0.16 cm)	0.062" (0.16 cm)	0.250" (0.64 cm)	PCTFE	0.9 µL	ea.
A-106	10 µm	0.094" (0.24 cm)	0.062" (0.16 cm)	0.250" (0.64 cm)	PCTFE	2.0 µL	ea.
A-107	10 µm	0.189" (0.48 cm)	0.062" (0.16 cm)	0.254" (0.65 cm)	PCTFE	9.1 µL	ea.
A-120	20 µm	0.125" (0.32 cm)	0.062" (0.16 cm)	0.250" (0.64 cm)	PCTFE	3.7 µL	ea.
A-122	20 µm	0.188" (0.48 cm)	0.062" (0.16 cm)	0.254" (0.65 cm)	PCTFE	9.7 µL	ea.
A-224	20 µm	0.188" (0.48 cm)	0.062" (0.16 cm)	0.254" (0.65 cm)	PTFE	9.7 µL	ea.
A-331	10 µm	0.750" (1.91 cm)	0.062" (0.16 cm)	0.880" (2.24 cm)	ETFE	141.9 µL	ea.
A-332	2 µm	0.750" (1.91 cm)	0.062" (0.16 cm)	0.880" (2.24 cm)	ETFE	141.9 µL	ea.
A-337	20 µm	0.750" (1.91 cm)	0.062" (0.16 cm)	0.880" (2.24 cm)	ETFE	152 µL	ea.
A-343	2 µm	0.625" (1.59 cm)	0.062" (0.16 cm)	0.750" (1.91 cm)	PCTFE	112.6 µL	ea.



PEEK Frits

- › Inert, biocompatible, and metal-free
- › Uniform porosity, longer filtration life
- › Sealing rings manufactured from PCTFE

Patented IDEX Health & Science PEEK Frits offer exceptionally uniform porosity. This property ensures longer filtration life and consistent frit-to-frit swept volumes. The PEEK polymer frit discs are biocompatible and inert to most solvents, making them well-suited for bioanalytical applications. PEEK's robust properties make these products suitable for low and high pressure applications.

Disc rings, included on all PEEK frits, are made of PCTFE and are slightly thicker than the frit disc, providing enhanced sealing and excellent chemical resistance. PCTFE surrounded PEEK frits can be used up to 80 °C.

0.5 µm PEEK Frits

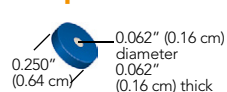

A-701

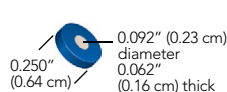

A-703

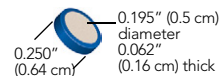

A-707

2 µm PEEK Frits

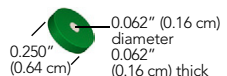

A-700



A-702

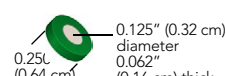

A-704

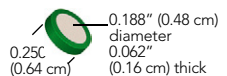

A-706

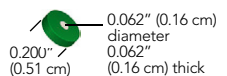

A-708

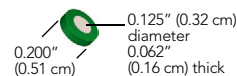

A-710

2 µm Semi-Prep PEEK Frits

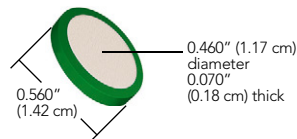

OC-802

5 µm and 10 µm PEEK Frits

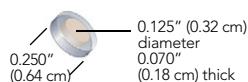

A-720

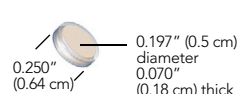

A-722

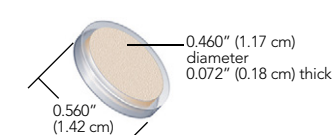

OC-803

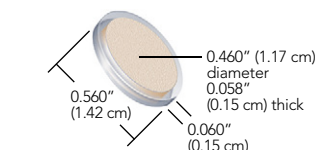

OC-805

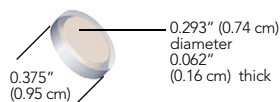

OC-815

PEEK Frits (Cont.)

NOTE

- › The thickness dimension in the part drawings and the pricing tables represents the thickness of the frit disc not the frit ring. Frit rings are often slightly thicker to ensure a proper seal. When tightened into a filter holder the ring compresses to nearly match the thickness of the frit disc.
- › The manufacturing process may cause some slight color variance in our PEEK frits. This does not affect their quality or performance. Frit dimensions are approximate. Actual batch-to-batch frit dimensions may vary slightly.

RELATED PRODUCTS

Any 0.247" to 0.254" diameter frit (including polymer ring) can be used with the Standard HPLC Inline Solvent Filters on page 102 and the Standard Precolumn Filters on page 105.

APPLICATION NOTE

Frit Volume

The term "frit volume" refers to the volume of the various fluid pathways that comprise the matrix of a frit. A standard frit is a mass of small particles fused together through a controlled process of compression and heat. Because of their shape, there are gaps between the fused particles. Fluid makes its way through these gaps, creating a pathway from one side of the frit to the other (see the diagram, below, where the white circles represent frit particles, and the black area represents the void between the particles.)

Generally, when the frit particles increase in size, the frit's porosity increases as well. The larger the particles, the larger the gaps between particles. Cumulatively, these gaps comprise what is known as "frit volume." Using gravimetric determination, it has been experimentally shown that the total volume of any given frit may range from 18%–30%, depending upon the porosity of the frit.

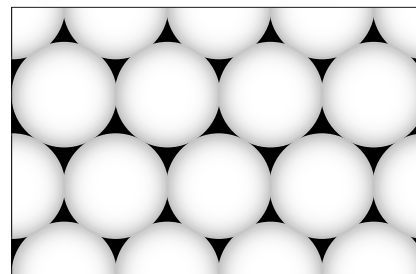

Frit volume is calculated by determining what the mass of the frit would be if it were a solid block of material of equal size. Then the solid mass of the frit is multiplied by the percentage assigned to the porosity to determine the theoretical frit volume.

20% for 0.5 µm frits 26% for 5 µm frits 30% for 20 µm frits
24% for 2 µm frits 28% for 10 µm frits

From a chromatographic perspective, it's important to know the volume of the frit used in your system. It is possible for a frit to negatively impact your chromatography if the total frit volume is too large and if it is placed in an area through which the sample will pass. To avoid frit-related problems like band broadening and loss of resolution, most inline filters placed after the sample introduction point (e.g., between the injection valve and the column) are smaller in size and porosity than inline filters that are placed in areas before the sample is introduced into the flow path (e.g., between the pump and the injection valve).

PEEK Frits

Part No.	Porosity	Disc Diameter	Disc Thickness	Ring OD	Ring Material	Frit Volume	Qty.
PEEK FRITS							
A-700	2 µm	0.062" (0.16 cm)	0.062" (0.16 cm)	0.250" (0.64 cm)	PCTFE	0.7 µL	ea.
A-701	0.5 µm	0.062" (0.16 cm)	0.062" (0.16 cm)	0.250" (0.64 cm)	PCTFE	0.6 µL	ea.
A-702	2 µm	0.091" (0.23 cm)	0.062" (0.16 cm)	0.250" (0.64 cm)	PCTFE	1.7 µL	ea.
A-703	0.5 µm	0.092" (0.23 cm)	0.062" (0.16 cm)	0.250" (0.64 cm)	PCTFE	1.4 µL	ea.
A-704	2 µm	0.125" (0.32 cm)	0.062" (0.16 cm)	0.250" (0.64 cm)	PCTFE	3.0 µL	ea.
A-706	2 µm	0.188" (0.48 cm)	0.062" (0.16 cm)	0.250" (0.64 cm)	PCTFE	7.1 µL	ea.
A-707	0.5 µm	0.195" (0.5 cm)	0.062" (0.16 cm)	0.250" (0.64 cm)	PCTFE	6.1 µL	ea.
A-708	2 µm	0.062" (0.16 cm)	0.062" (0.16 cm)	0.200" (0.51 cm)	PCTFE	0.7 µL	ea.
A-710	2 µm	0.125" (0.32 cm)	0.062" (0.16 cm)	0.200" (0.51 cm)	PCTFE	3.0 µL	ea.
SEMI-PREP PEEK FRITS							
A-720	10 µm	0.125" (0.32 cm)	0.070" (0.18 cm)	0.250" (0.64 cm)	PCTFE	4.2 µL	ea.
A-722	10 µm	0.197" (0.5 cm)	0.070" (0.18 cm)	0.250" (0.64 cm)	PCTFE	9.9 µL	ea.
OC-802	2 µm	0.460" (1.17 cm)	0.070" (0.18 cm)	0.560" (1.42 cm)	PCTFE	46.4 µL	ea.
OC-803	10 µm	0.460" (1.17 cm)	0.072" (0.18 cm)	0.560" (1.42 cm)	PCTFE	57.2 µL	ea.
OC-805	5 µm	0.460" (1.17 cm)	0.058" (0.15 cm)	0.560" (1.42 cm)	PCTFE	41.1 µL	ea.
OC-815	5 µm	0.293" (0.74 cm)	0.062" (0.16 cm)	0.375" (0.95 cm)	PCTFE	17.8 µL	ea.



Frit-in-a-Ferrule™

- › Seals and filters simultaneously
- › Less expensive and more convenient than traditional inline filter systems
- › Available in both Flangeless and Super Flangeless™ versions

Now you can filter at any point in your system where 1/16" or 1/8" OD tubing is used in a flat-bottom 1/4-28, M6 or 5/16-24 connection.

Our Frit-In-A-Ferrule product line is designed to seal and filter simultaneously by incorporating a frit into the body of a flat-bottom ferrule. This simple design allows you to eliminate traditional inline filters and reduce the number of additional connections in your system.

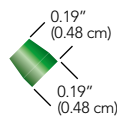

P-372
Flangeless Frit-In-A-Ferrule
for 1/8" OD tubing

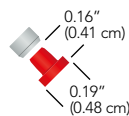

P-276
Super Flangeless Frit-In-A-Ferrule
for 1/16" OD tubing



Part No.	Description	Porosity	Frit Material	Frit Diameter	Frit Thickness	Swept Volume	Maximum Pressure	Qty.
FRIT-IN-A-FERRULE FOR 1/16" OD TUBING								
P-270	Super Flangeless, Natural PEEK, SST lock ring	2 µm	SST	0.062"	0.062"	0.74 µL	2,500 psi (172 bar)	ea.
P-272	Flangeless, Green PCTFE	2 µm	SST	0.062"	0.062"	0.74 µL	2,000 psi (138 bar)	ea.
P-273	Flangeless, Blue PCTFE	0.5 µm	SST	0.062"	0.062"	0.61 µL	2,000 psi (138 bar)	ea.
P-274	Super Flangeless, Natural PEEK, SST lock ring	2 µm	PEEK	0.046"	0.030"	0.20 µL	2,500 psi (172 bar)	ea.
P-275	Super Flangeless, Black PEEK, SST lock ring	0.5 µm	PEEK	0.046"	0.030"	0.16 µL	2,500 psi (172 bar)	ea.
P-276	Super Flangeless, Stainless Steel, Natural ETFE, SST lock ring	10 µm	SST	0.062"	0.062"	0.90 µL	2,500 psi (172 bar)	ea.
FRIT-IN-A-FERRULE FOR 1/8" OD TUBING								
P-372	Flangeless, Green PCTFE	2 µm	SST	0.094"	0.062"	1.69 µL	500 psi (34 bar)	ea.
P-373	Flangeless, Blue PCTFE	0.5 µm	SST	0.094"	0.062"	1.41 µL	500 psi (34 bar)	ea.
P-374	Super Flangeless**, Natural PEEK, SST lock ring	2 µm	PEEK	0.094"	0.042"	1.15 µL	2,500 psi (172 bar)	ea.

* Swept volumes include/reflect theoretical frit volume values.

** The 1/8" Super Flangeless versions cannot be used in M6 ports.



Bottom-of-the-Bottle™ Filters

Our uniquely designed Bottom-of-the-Bottle™ Filters effectively protect your system by filtering out particulate matter that may otherwise damage expensive hardware.

Stainless Steel Bottom-of-the-Bottle Solvent Filters

- › Draws solvent from within 1/8" of the bottom of the bottle
- › Replaceable stainless steel filter cups
- › Versions for 1/8" and 3/16" OD tubing
- › Materials of construction: PEEK, ETFE, and 316 Stainless Steel

Patented Stainless Steel Bottom-of-the-Bottle Solvent Filter Assemblies feature a 2 µm or 10 µm replaceable stainless steel filter cup and a design that allows solvent to be drawn from within 1/8" of the bottom of your solvent bottle. The filter cups are inexpensive and easy to replace, making this an economical, trouble-free choice.

A-550 Bottom-of-the-Bottle Inlet Solvent Filter

Maximum Flow Rates:
2 µm—up to 10 mL/min.
10 µm—up to 40 mL/min.

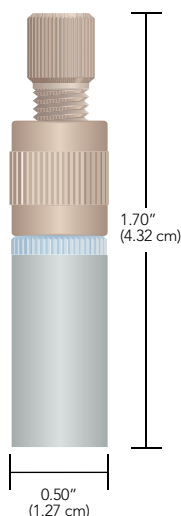

All-PEEK Bottom-of-the-Bottle Solvent Filters

- › Most recommended filtering unit
- › 100% PEEK polymer construction
- › Easy operation — no fittings required

These biocompatible filters are made from 100% PEEK polymer, including the two built-in PEEK frits. The bottom frit (2 µm or 10 µm) will draw solvents from within 0.080" (2.0 mm) of the bottom of the solvent bottle. The 2 µm frit on the side may be used for a 1/8" OD helium sparging line.

To use, simply press fit your appropriately sized fluoropolymer tubing firmly into the top holes. That's it!

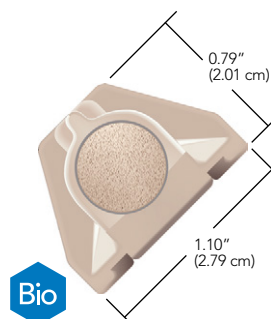
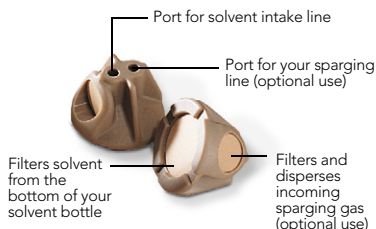

A-435
Bottom-of-the-Bottle Filter

Maximum Flow Rate: up to 30 mL/min

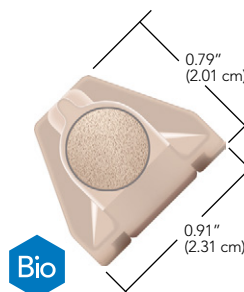

A-438
Bottom-of-the-Bottle Filter
(for small neck bottles)

UHMWPE Bottom-of-the-Bottle™ Solvent Filters

- › Replaceable filter cup
- › Economical
- › Materials of construction: UHMWPE, ETFE
- › Versions for 1/16" and 1/8" OD tubing

The design of the UHMWPE solvent filters allows tubing to pass through to the bottom of the filter cup, enabling the filter to draw solvent from within 0.10" (2.5 mm) of the bottom of your solvent bottle.

Please Note: UHMWPE is a hydrophobic material. To establish proper surface wetting, you may need to prime the filter with methanol or acetonitrile.

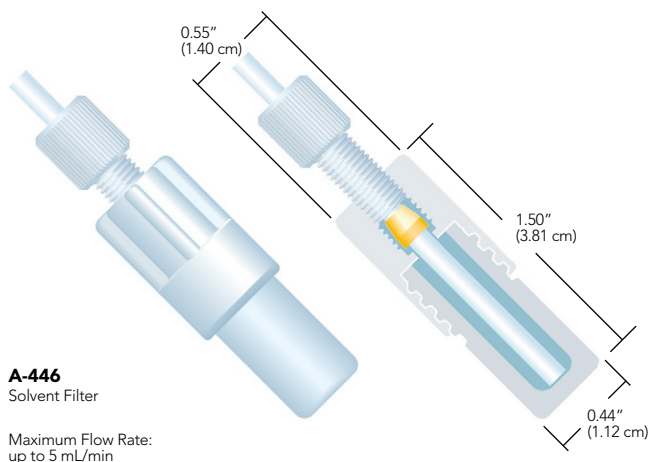

Bottom-of-the-Bottle Filters

Part No.	Description	Porosity	For Tubing Size	Includes	Qty.
STAINLESS STEEL BOTTOM-OF-THE-BOTTLE SOLVENT FILTERS					
A-550	SST Filter Assembly, with A-520 filter cup	10 µm	1/8" OD	(1) XP-130	ea.
A-551	SST Filter Assembly, with A-522 filter cup	2 µm	1/8" OD	(1) XP-130	ea.
A-520x	SST Replacement Solvent Filter Cups, 10-pk	10 µm	—	—	ea.
A-522x	SST Replacement Solvent Filter Cups, 10-pk	2 µm	—	—	ea.
ALL-PEEK BIOCOMPATIBLE BOTTOM-OF-THE-BOTTLE SOLVENT FILTERS					
A-435	PEEK Filter	2 µm	1/8" OD	—	ea.
A-437	PEEK Filter, for small-neck (GL-38) bottles	2 µm	1/8" OD	—	ea.
A-438	PEEK Filter, for small-neck (GL-38) bottles	10 µm	1/8" OD	—	ea.
A-440	PEEK Filter	10 µm	1/8" OD	—	ea.
A-441	PEEK Filter	10 µm	3/16" OD	—	ea.
A-451	PEEK Filter	10 µm	1/16" OD	—	ea.
UHMWPE BIOCOMPATIBLE BOTTOM-OF-THE-BOTTLE SOLVENT FILTERS					
A-445	UHMWPE Filter Assembly	10 µm	1/16" OD	(1) XP-245	ea.
A-446	UHMWPE Filter Assembly	10 µm	1/8" OD	(1) XP-345	ea.
A-427	UHMWPE Replacement Solvent Filter Cups, 5-pk	10 µm	—	—	ea.



Inlet Solvent Filters

- ▶ Large surface areas prevent pump cavitation
- ▶ Disposable
- ▶ 2 μm , 10 μm , and 20 μm pore sizes available
- ▶ General use and prep filters for higher flow applications



APPLICATION NOTE

Why Use An Inlet Solvent Filter?

- ▶ To filter out particulate matter from the solvent that may otherwise damage expensive hardware. (Use a 10 μm or 20 μm version for this purpose. The A-309 and A-230A filters have an added "Bottom of the Bottle™" feature to help draw solvent to within 1/8" of the bottom of your solvent bottle.)
- ▶ To prevent particulates originating from the sparging system from entering the mobile phase reservoir and to help disperse the sparging gas efficiently. (Use a 2 μm filter for this purpose.)
- ▶ To hold your tubing in place at the bottom of the bottle. (Most stainless steel filter options work best for this purpose.)

Note: It is usually a good idea to change the inlet filter as part of your semi-annual or annual preventative maintenance program.

It is good practice to filter your solvents to prevent pump damage. Our 316 stainless steel filters provide that protection.

Because filters should be changed periodically, we make it easy to replace them without tools. For those filters using a plastic fitting, the tubing can be reconnected by finger tightening the fitting into the new filter. The filters with stems allow easy insertion into the inlet tubing.

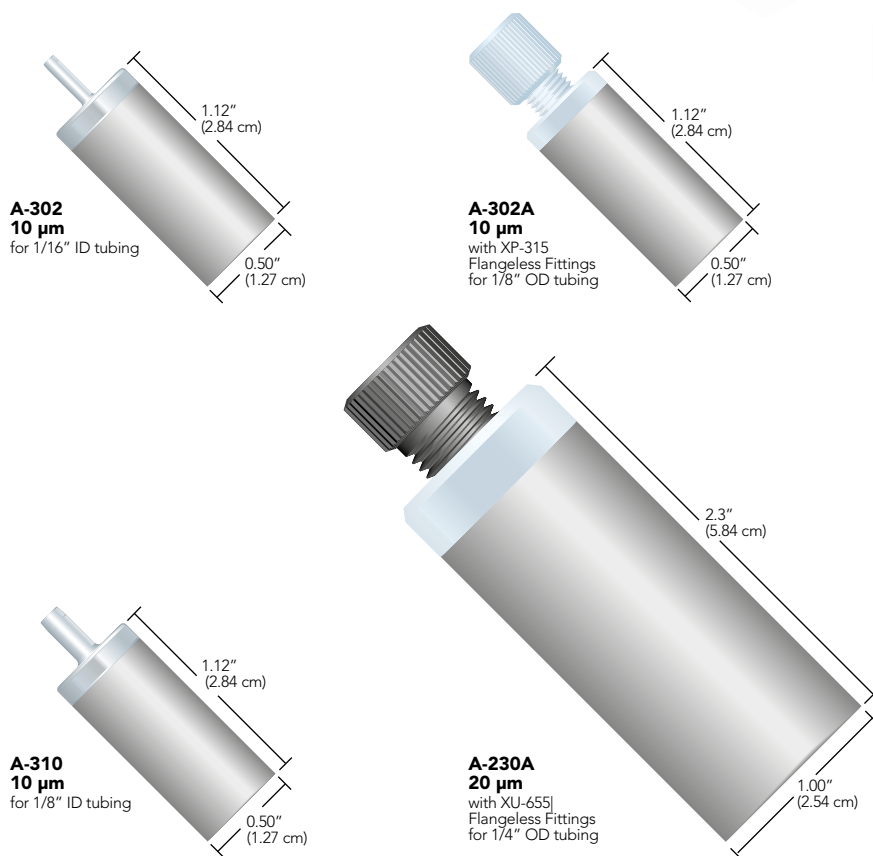

Part No.	Description	Porosity	Material	For Tubing Size	Includes	Max. Suggested Flow Rate*	Qty.
INLET SOLVENT FILTERS FOR ANALYTICAL HPLC							
A-242	Inlet Solvent Filter with One-Piece Fitting	2 μm	PCTFE, SST	1/8" OD	(1) P-100	10 mL/min	ea.
A-243	A-242, 5-pack	2 μm	PCTFE, SST	1/8" OD	(5) P-100	10 mL/min	ea.
A-228	Inlet Solvent Filter with stem	2 μm	SST	1/8" ID	—	80 mL/min	ea.
A-302	Inlet Solvent Filter with stem	10 μm	SST	1/16" ID	—	40 mL/min	ea.
A-302A	Inlet Solvent Filter with Flangeless Fittings	10 μm	PCTFE, SST	1/8" OD	(1) XP-315	40 mL/min	ea.
A-309	Inlet Solvent Filter with stem	10 μm	SST	1/16" ID	—	40 mL/min	ea.
A-231A	Inlet Solvent Filter with Flangeless Fittings	20 μm	PCTFE, SST	3/16" OD	(1) XP-132	100 mL/min	ea.
A-310	Inlet Solvent Filter with stem	10 μm	SST	1/8" ID	—	40 mL/min	ea.
INLET SOLVENT FILTERS FOR PREPARATIVE HPLC SYSTEMS							
A-225	Inlet Solvent Filter with stem	20 μm	SST	1/16" ID	—	100 mL/min	ea.
A-225A	Inlet Solvent Filter with Flangeless Fittings	20 μm	PCTFE, SST	1/8" OD	(1) P-315, (1) P-300N	100 mL/min	ea.
A-227A	Inlet Solvent Filter with Flangeless Fittings	10 μm	PCTFE, SST	1/4" OD	(1) XU-655	100 mL/min	ea.
A-230A	Inlet Solvent Filter with Flangeless Fittings	20 μm	PCTFE, SST	1/4" OD	(1) XU-655	100 mL/min	ea.
A-311	Inlet Solvent Filter with stem	10 μm	SST	1/16" ID	—	100 mL/min	ea.
A-311A	Inlet Solvent Filter with Flangeless Fittings	10 μm	PCTFE, SST	1/8" OD	(1) XP-315	100 mL/min	ea.

* Maximum suggested flow rates are determined by porosity and surface area.



Inline Filters

- › Specially engineered for inline filtration
- › Versions include Micro, Standard, and Semi-Preparative
- › Bio-inert and stainless steel options offered
- › Variety of porosities, application appropriate

Our Inline Filters are specially engineered for inline filtration. It is specifically designed to help prevent particulate contamination from clogging sensitive equipment. It is ideally suited for placement along the flow path line between the pump and injection valve/autosampler. We offer a variety of porosities for your application.

Standard Inline Solvent Filters

- › For 1/16" OD tubing
- › Versions for Standard HPLC (6,000 psi/414 bar) and UHPLC (25,000 psi/1,725 bar)
- › Replacement frits available Versions for Standard HPLC (6,000 psi/414 bar) and UHPLC (25,000 psi/1,725 bar)
- › Help prevent particulate contamination from clogging sensitive equipment
- › Ideally suited for placement along the flow path line between the pump and injection valve/autosampler

RELATED PRODUCTS

Fittings

All Standard Inline Solvent Filters have 10-32 threads for 1/16" OD tubing, allowing the use of most standard chromatography high pressure fittings.

Inline filter assemblies that begin with the letter "A" are engineered for standard HPLC applications (up to 6,000 psi/414 bar). Inline Filter Assemblies that begin with the "VHP" prefix are suitable for use in UHPLC systems, where pressures can reach 25,000 psi (1,725 bar).

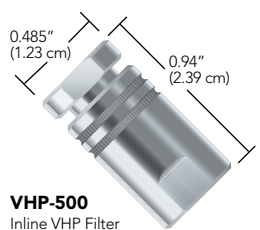
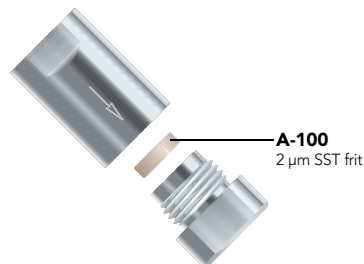
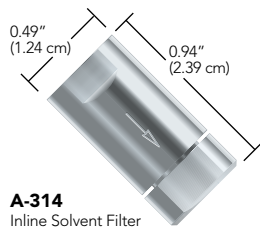
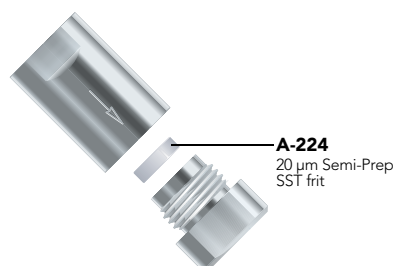
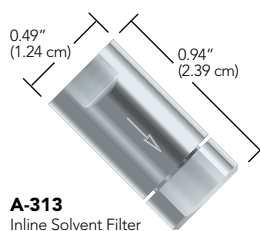

Biocompatible Standard Inline Filters

- › 0.5 µm and 2 µm versions available
- › Features 100% PEEK flow path

Our A-430 and A-431 Inline Filters consist of a stainless steel body and two PEEK end fittings. Maximum recommended flow rate is 25 mL/min for the A-430 Filter and 10 mL/min for the A-431 Filter. And, you get the added benefit of biocompatibility since all wetted surfaces are PEEK. When you need to replace the frit, simply dispose of the end fitting that contains the frit and replace it with a new one.

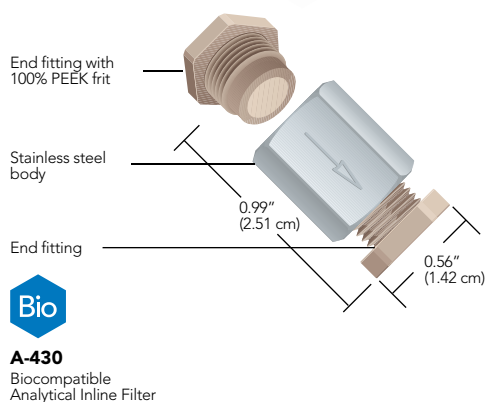

Inline Filters

Part No.	Description	Porosity	For Tubing Size	Threads	Includes	Swept Volume	Pressure Rating	Qty.
STANDARD INLINE SOLVENT FILTERS								
A-313	Solvent Filter Assembly	20 µm	1/16" OD	10-32 Coned	(1) A-224	12.3 µL	6,000 psi (414 bar)	ea.
A-314	Solvent Filter Assembly	2 µm	1/16" OD	10-32 Coned	(1) A-100	4 µL	6,000 psi (414 bar)	ea.
A-100	Replacement Frits, Stainless Steel, ea.	2 µm	N/A	—	—	1.4 µL	N/A	ea.
A-224	Replacement Frits, Stainless Steel, ea.	20 µm	N/A	—	—	9.7 µL	N/A	ea.
VHP-500	Inline VHP Filter	0.5 µm	1/16" OD	10-32 Coned	(5) VHP-501	1.2 µL	25,000 psi (1,725 bar)	ea.
VHP-505	Inline VHP Filter	0.2 µm	1/16" OD	10-32 Coned	(5) VHP-506	1.1 µL	25,000 psi (1,725 bar)	ea.
VHP-501	Replacement Inline VHP Frit	0.5 µm	N/A	N/A	N/A	0.60 µL	N/A	ea.
VHP-506	Replacement Inline VHP Frit	0.2 µm	N/A	N/A	N/A	0.54 µL	N/A	ea.
BIOCOMPATIBLE INLINE FILTERS								
A-430	Biocompatible Filter Assembly	2 µm		10-32 Coned	(1) A-429	7.1 µL	6,000 psi (414 bar)	ea.
A-431	Biocompatible Filter Assembly	0.5 µm		10-32 Coned	(1) A-428	5.9 µL	6,000 psi (414 bar)	ea.
A-428x	PEEK Filter End Fittings, Black PEEK body, 10-pk	0.5 µm		10-32 Coned	—	5.7 µL	N/A	10-pk
A-429x	PEEK Filter End Fittings, Natural PEEK body, 10-pk	2 µm		10-32 Coned	—	6.9 µL	N/A	10-pk

*Swept volumes include/reflect theoretical frit volume values.
SST = Stainless Steel



Precolumn Filters

Our economical Precolumn Filters offer secure protection for analytical columns in HPLC and UHPLC. We offer traditional versions that can successfully connect tubing on both sides and our direct-connect versions attach to the inlet port of most standard columns. All versions feature a 10-32 coned ports for 1/16" OD tubing.

Standard Precolumn Filters

- › Economical protection for larger columns and injections
- › Traditional versions connect tubing on both sides
- › Direct-connect versions attach to the inlet port of most standard columns
- › All versions feature 10-32 coned ports for 1/16" OD tubing

These are designed to protect columns by filtering out particulate matter originating from the sample or from rotor seal wear.

- › Assemblies that begin with the letter "A" are traditional versions for standard HPLC
- › Assemblies that begin with "VHP" are direct-connect versions for UHPLC applications
- › Versions that begin with "9085" are direct-connect for standard HPLC and must be used with polymer fittings

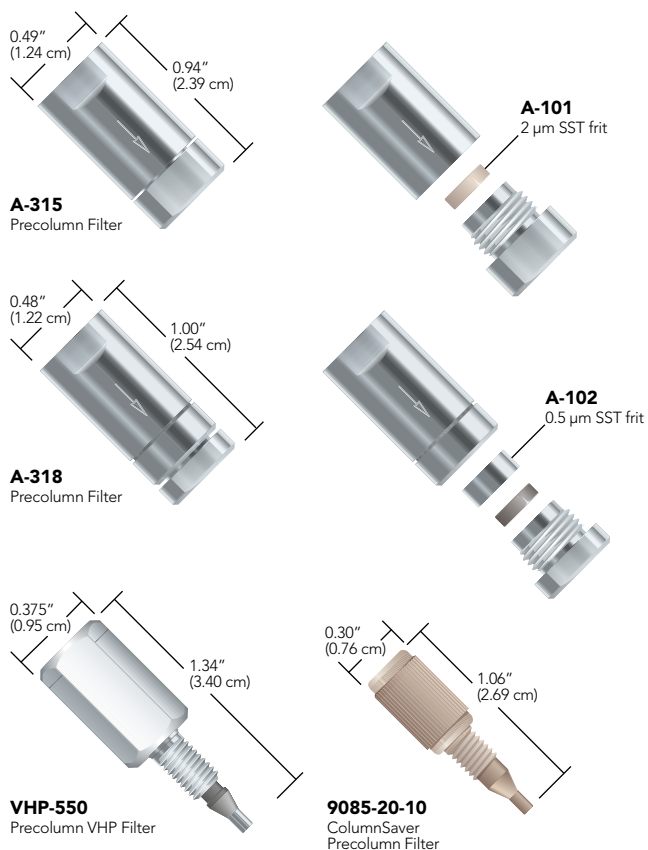

Precolumn Filters (Cont.)

Biocompatible Precolumn Filters

- › Pre-assembled with either 0.5 µm or 2 µm porosity frits
- › Great column protection
- › Feature PEEK bodies and PCTFE-surrounded PEEK frits

Biocompatible Precolumn Filters have 0.020" (0.50 mm) diameter thru-holes and 8° distribution cones for minimal band spreading and mixing. The bodies of these filters are manufactured from biocompatible PEEK polymer and are pressure rated to 5,000 psi (345 bar). These filters are designed for use with 1/16" OD tubing, which can be connected to these filters using standard Fingertight fittings.

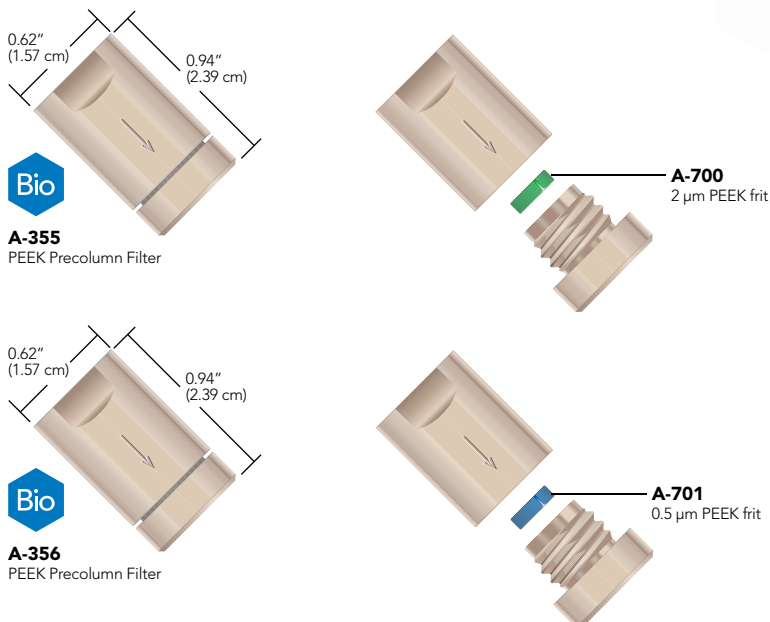

Precolumn Filters

Part No.	Description	Porosity	For Tubing Size	Threads	Includes	Swept Volume*	Pressure Rating	Qty.
STANDARD PRECOLUMN FILTERS								
A-315	Solvent Filter Assembly	2 µm	1/16" OD	10-32 Coned	(1) A-101	1.4 µL	6,000 psi (414 bar)	ea.
A-318	Solvent Filter Assembly	0.5 µm	1/16" OD	10-32 Coned	(1) A-102	0.84 µL	6,000 psi (414 bar)	ea.
A-101	Replacement Frits, Stainless Steel, ea.	2 µm	N/A	—	—	0.74 µL	N/A	ea.
A-102	Replacement Frits, Stainless Steel, ea.	0.5 µm	N/A	—	—	0.61 µL	N/A	ea.
VHP-550	Precolumn VHP Filter	0.5 µm	1/16" OD	10-32 Coned	(5) VHP-551	1.9 µL	20,000 psi (1,380 bar)	ea.
VHP-555	Precolumn VHP Filter	0.2 µm	1/16" OD	10-32 Coned	(5) VHP-556	1.8 µL	20,000 psi (1,380 bar)	ea.
VHP-551	Replacement Precolumn VHP Frit Assembly	0.5 µm	N/A	N/A	N/A	1.9 µL	N/A	ea.
VHP-556	Replacement Precolumn VHP Frit Assembly	0.2 µm	N/A	N/A	N/A	1.8 µL	N/A	ea.
9085-05-10	ColumnSaver Precolumn Filter, with SST frit	0.5 µm	1/16" OD	10-32 Coned	N/A	3.1 µL	6,000 psi (414 bar)	10-pk
9085-20-10	ColumnSaver Precolumn Filter, with SST frit	2 µm	1/16" OD	10-32 Coned	N/A	3.1 µL	6,000 psi (414 bar)	10-pk
BIOCOMPATIBLE PRECOLUMN FILTERS								
A-355	Solvent Filter Assembly, Biocompatible	2 µm		10-32 Coned	(1) A-700	1.4 µL	5,000 psi (345 bar)	ea.
A-356	Solvent Filter Assembly, Biocompatible	0.5 µm		10-32 Coned	(1) A-701	1.3 µL	5,000 psi (345 bar)	ea.
A-700	Replacement Frit, PEEK Polymer	2 µm		—	—	0.74 µL	N/A	ea.
A-701	Replacement Frit, PEEK Polymer	0.5 µm		—	—	0.61 µL	N/A	ea.

SST = Stainless Steel

*Swept volumes include/reflect theoretical frit volume values.



Semi-Prep Filters

Biocompatible Semi-Prep Filters consist of a stainless steel body, two PEEK end fittings, and a separate PEEK frit. These filters are ideal for many higher flow analytical, semi-prep and preparative applications. Best of all, if the filter becomes clogged, simply unscrew the assembly, remove the frit and replace it. The frits are interchangeable.

Semi-Prep Inline Filters

- › Designed for high-flow applications
- › Economical protection for larger columns and injections
- › SFC and HPLC compatible

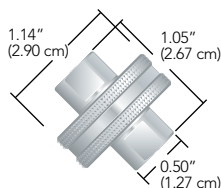

A-330
High Pressure Semi-Prep Inline Filter

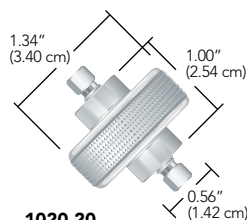

1020-20
Iso-Prep Filter
Shown with standard 10-32 stainless steel nuts and ferrules (not included)

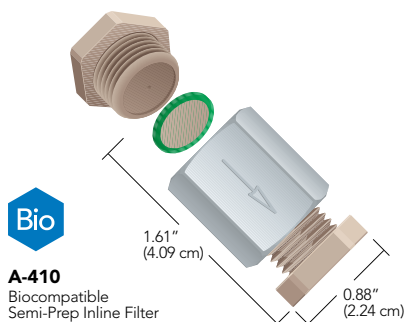

A-410
Biocompatible
Semi-Prep Inline Filter

Biocompatible Semi-Prep Inline Filters

- › Versions for 1/16", 1/8", 3/16", 1/4", and 5/16" OD tubing
- › 100% PEEK flow path

Biocompatible Semi-Prep Filters consist of a stainless steel body, two PEEK end fittings, and a separate PEEK frit. These filters are ideal for many higher flow analytical, semi-prep and preparative applications. Best of all, if the filter becomes clogged, simply unscrew the assembly, remove the frit and replace it. The frits are interchangeable.

Part No.	Description	Porosity	Threads	Includes	Swept Volume*	Pressure Rating	Qty.
SEMI-PREP INLINE FILTERS							
A-330	Semi-Prep Filter Assembly	10 µm	10-32 Coned	(1) A-331	223 µL	7,500 psi (517 bar)	ea.
A-360	Semi-Prep Filter Assembly	10 µm	5/16-24 Flat Bottom	(1) A-331	235 µL	3,500 psi (207 bar)	ea.
A-331	Stainless Steel Frits, Natural ETFE ring	10 µm	N/A	N/A	142 µL	N/A	ea.
A-332	Stainless Steel Frits, Natural ETFE ring	2 µm	N/A	N/A	122 µL	N/A	ea.
A-337	Stainless Steel Frits, Natural ETFE ring	20 µm	N/A	N/A	152 µL	N/A	ea.
ISO-PREP FILTERS							
1020-05	21.2 mm Filter Holder	0.5 µm	10-32 Coned	(1) 7031-05	203 µL	8,000 psi (552 bar)	ea.
1020-20	21.2 mm Filter Holder	2 µm	10-32 Coned	(1) 7031-20	196 µL	8,000 psi (552 bar)	ea.
7031-05	21.2 mm Replacement Filter	0.5 µm	N/A	N/A	122 µL	8,000 psi (552 bar)	ea.
7031-20	21.2 mm Replacement Filter	2 µm	N/A	N/A	115 µL	8,000 psi (552 bar)	ea.
BIOCOMPATIBLE SEMI-PREP INLINE FILTERS							
A-410	Biocompatible Filter Assembly	2 µm	10-32 Coned	(1) OC-802	89 µL	6,000 psi (414 bar)	ea.
A-411	Biocompatible Filter Assembly	10 µm	10-32 Coned	(1) OC-803	103 µL	6,000 psi (414 bar)	ea.
A-510	Biocompatible Filter Assembly	5 µm	5/16-24 Flat Bottom	(1) OC-805	89 µL	500 psi (34 bar)	ea.
OC-802	PEEK Frit, Green PCTFE ring	2 µm	N/A	N/A	46 µL	N/A	ea.
OC-803	PEEK Frit, Natural PCTFE ring	10 µm	N/A	N/A	57 µL	N/A	ea.
OC-805	PEEK Frit, Natural PCTFE ring	5 µm	N/A	N/A	50 µL	N/A	ea.

*Swept volumes include/reflect theoretical frit volume values.



Inline MicroFilters

- › 100% biocompatible PEEK polymer option available
- › Miniscule 240 nL void volume
- › Two versions: direct connect 1/32" OD tubing or use MicroTight® tubing sleeves for 70–520 µm OD capillary tubing

Our Inline MicroFilters protect your column from particles originating in the mobile phase or sample, or from pump seal and sample injection valve wear. These filters have a 0.006" (150 µm) thru-hole. Choose the M-520 with a 0.5 µm 100% PEEK frit to connect to capillary tubing using the MicroTight tubing sleeves (page 52). You may also directly connect 1/32" OD tubing using the M-525 which contains a 0.5 µm PEEK frit.

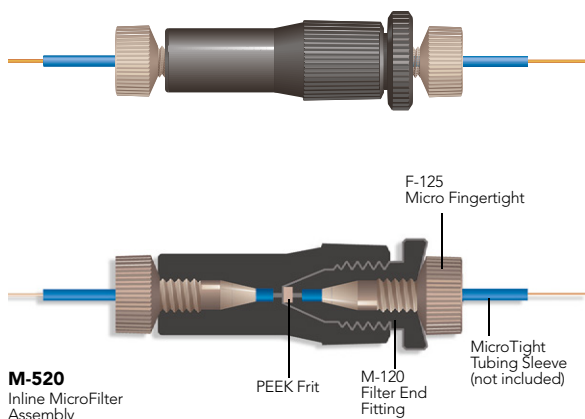

M-520
Inline MicroFilter
Assembly



M-525
Inline MicroFilter
Assembly

Part No.	Description	Porosity	For Tubing Size	Threads	Includes	Swept Volume	Pressure Rating	Qty.
INLINE MICROFILTERS								
M-520	Inline MicroFilter Assembly, PEEK Frit	0.5 µm	MicroTight Tubing Sleeve	MicroTight Tubing Sleeve	(5) M-120, (2) F-125	240 nL	4,000 psi (276 bar)	ea.
M-525	Inline MicroFilter Assembly, PEEK Frit	0.5 µm	1/32" OD	1/32" OD	(5) M-140, (2) F-126	240 nL	4,000 psi (276 bar)	ea.
REPLACEMENT INLINE MICROFILTER END-FITTINGS								
M-120x	End-Fittings, Black, with PEEK Frit	0.5 µm	MicroTight Tubing Sleeve	MicroTight Tubing Sleeve	N/A	216 nL	N/A	10-pk
M-140x	End-Fittings, Natural, with PEEK Frit	0.5 µm	1/32" OD	1/32" OD	N/A	216 nL	N/A	10-pk



Mini MicroFilters

- › Total volume as low as 10 nL
- › Conductive version for CEC and mass spectrometry applications

Our Inline Mini MicroFilter Assemblies filter effectively with internal volumes low enough to ensure reliable chromatographic results — even at nanoliter per minute flow rates! Internal volumes of these encapsulated filters are as low as 85 nL with the micro-screen and 10 nL to 22 nL with the frit disc option.



APPLICATION NOTE

The Mini MicroFilters can be used to pack capillary tubing. Simply place one of these filters on the effluent side of the capillary tubing, then slurry pack. Once packed, place a filter at the head of the tubing. This creates a reliable capillary column without fusing the silica to make frits or pressing filter paper inside the capillary tubing.

Increase the Life of Your Column

Why use a Precolumn Filter when there is a frit at the head of the column itself? Changing the column frit is extremely difficult to do without disturbing the column packing. A Precolumn Filter provides relatively inexpensive insurance against column damage, and changing its frit is easy. A Precolumn Filter placed between the sample injection valve and the HPLC column protects the column from particles originating in the sample and from pump and valve seal wear.

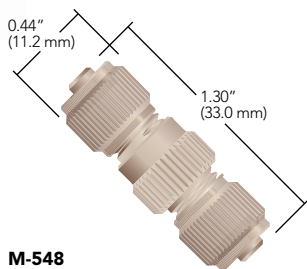

M-548
Mini MicroFilter Assembly



SPECIFICATIONS & DETAILS

Because of the size-specific nature of the ferrules included with each Mini MicroFilter assembly, please note that these ferrules are not interchangeable with other MicroFerrules for different tubing sizes.

Filter Capsule Color Identification



M-121



M-125



M-128



M-131



M-133

What's the Difference Between Precolumn & Inline Filters?

You may have noticed that the bodies of Precolumn and Inline Filters look similar, and as such, you may have wondered what the differences are. Because Precolumn Filters, by definition, are typically placed in a volume-sensitive area immediately preceding the column, these filters usually feature smaller thru-holes and smaller frit diameters. In contrast, Inline Filters are often placed where the internal volume is not as critical and where longer life and less fluid restriction is more important.

Part No.	Description	Porosity	Frit Type	For use with Tubing	Includes	Swept Volume	Pressure Rating	Qty.
MINI MICROFILTER ASSEMBLY								
M-547	Mini MicroFilter Assembly	1 µm	SST Frit	1/32" (790 µm) OD	(5) M-133, (2) F-112, (2) P-416	22 nL	4,000 psi (276 bar)	ea.
M-548	Mini MicroFilter Assembly	1 µm	Ti Frit	1/32" (790 µm) OD	(5) M-134, (2) F-112, (2) P-416	22 nL	4,000 psi (276 bar)	ea.
REPLACEMENT MINI MICROFILTER CAPSULES								
Part No.	Description	Porosity	Frit Type	For Use With	Material	Swept Volume		Qty.
M-121	Filter Capsule	1 µm	SST Screen	M-530 and M-531	PEEK	85 nL		2-pk
M-125	NanoFilter Capsule	1 µm	SST Frit	M-537 and M-538	PEEK	10 nL		2-pk
M-126	NanoFilter Capsule	1 µm	Ti Frit	M-537 and M-538	PEEK	10 nL		2-pk
M-131	Filter Capsule	1 µm	SST Screen	M-543	PEEK	85 nL		2-pk
M-133	NanoFilter Capsule	1 µm	SST Frit	M-547 and M-548	PEEK	10 nL		2-pk
M-134	NanoFilter Capsule	1 µm	Ti Frit	M-547 and M-548	PEEK	10 nL		2-pk
M-128	Conductive NanoFilter Capsule	1 µm	SST Frit	M-534	SST/PEEK	10 nL		2-pk

SST = Stainless Steel; Ti = Titanium



Precolumn MicroFilters

- › Direct connects to columns with 10-32 threads
- › Total void volume of 0.5 μ L
- › Two versions: direct connect 1/16" OD tubing or use MicroTight® tubing sleeves for 70–520 μ m OD capillary tubing

The Precolumn MicroFilters directly connect into your microbore or analytical column. Total theoretical void volume is only 0.5 μ L (includes frit volume) and the PEEK tubing used in the assembly of these units has a 0.005" (125 μ m) ID, virtually eliminating any mixing of the sample with the mobile phase.

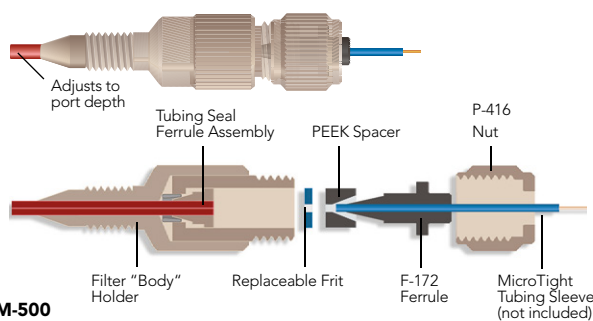

M-500
Precolumn MicroFilter Assembly
(Includes indicated products)

Part No.	Description	Porosity For Tubing Size		Threads	Includes	Swept Volume*	Pressure Rating	Qty.
PRECOLUMN MICROFILTER ASSEMBLIES								
M-500	Precolumn MicroFilter Assembly, SST Frit	0.5 μ m	MicroTight Tubing Sleeve	10-32 Coned	(5) C-425, (1) F-172, (1) P-416	0.5 μ L	4,000 psi (276 bar)	ea.
M-510	Precolumn MicroFilter Assembly, PEEK Frit	0.5 μ m	MicroTight Tubing Sleeve	10-32 Coned	(5) A-735, (1) F-172, (1) P-416	0.5 μ L	4,000 psi (276 bar)	ea.
M-550	Precolumn MicroFilter Assembly, SST Frit	0.5 μ m	1/16" OD	10-32 Coned	(5) C-425, (1) F-132, (1) P-416	0.5 μ L	4,000 psi (276 bar)	ea.
M-560	Precolumn MicroFilter Assembly, PEEK Frit	0.5 μ m	1/16" OD	10-32 Coned	(5) A-735, (1) F-132, (1) P-416	0.5 μ L	4,000 psi (276 bar)	ea.
REPLACEMENT PRECOLUMN MICROFILTER FRITS (FRIT DIAMETER X FRIT THICKNESS X OVERALL DIAMETER)								
A-735	PEEK Frits, 0.045" x 0.031" x 0.192"	0.5 μ m	N/A	N/A	N/A	216 nL	N/A	ea.
C-420	SST Frits, 0.038" x 0.028" x 0.192"	2 μ m	N/A	N/A	N/A	101 nL	N/A	ea.
C-425	SST Frits, 0.038" x 0.028" x 0.192"	0.5 μ m	N/A	N/A	N/A	101 nL	N/A	ea.



Bottle Caps

- › Extremely simple — no threaded ports or fittings
- › Manufactured from ETFE and Polypropylene



APPLICATION NOTE

- › A self-regulating sparging system can help reduce helium consumption and improve pump performance. Set this up by pressing your tubing through the appropriate holes in your bottle cap and attaching each line to a filter. Sparge your mobile phase with an inert gas (preferably helium) for 15–20 minutes. Then reduce the outlet pressure of the sparging gas to a maximum of 5 psi (0.34 bar) and insert a plug (A-626 or A-628) into the remaining port of the cap. The sparging gas will shut off once the incoming pressure equals the pressure inside the reservoir. As the mobile phase is consumed and the internal pressure lowers, sparging gas will enter to keep the system pressurized and degassed. Please *Note: If gas leaks while pressurizing the bottle, try removing the sealing ring from the bottle, as it sometimes interferes with the sealing of these bottle caps.*
- › One concern with sparging systems is the possibility of solvent backing up the sparging inlet line. This can occur if the gas tank completely evacuates with the regulating valves open, creating a vacuum in the tubing. Solvent backup may damage sparging system components and cause cross-contamination of mobile phase reservoirs. To help prevent solvent backup, install the CV-3010 In-line Check Valve (page 135) along the tubing line that runs between the gas supply and the solvent bottle.
- › For a more efficient degassing system, please see the HPLC Vacuum Degassing Systems on page 154.
- › Please see the Quick-Stop Luer Check Valve on page 139 for another solvent inlet Application Note.

If you are looking for a bottle cap that is quick and easy to use, but still allows many connection options, we have just what you need! The Bottle Caps fit standard GL-45 (1 L) or smaller-neck GL-38 (4 L) glass bottles.

Each cap has three holes. With two of the holes you simply push your tubing straight through. The third hole, with a luer taper, can be used for a number of options. Any male luer (such as a luer-lock syringe) will fit snugly in this hole, or you can use the A-626 or A-627 Plug. Exceptions are the A-610 Bottle Caps. Please see the note below.

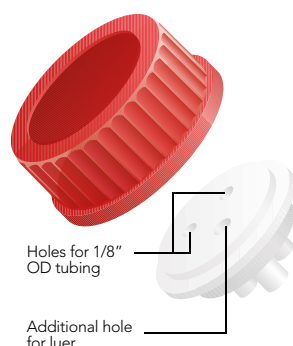

A-620
GL-45 Bottle Cap
for 1/8" tubing

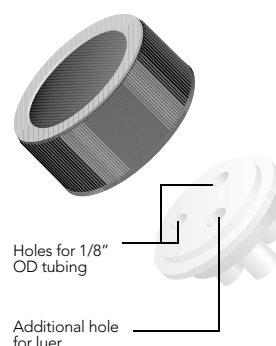

A-622
GL-38 Bottle Cap
for 1/8" tubing



NOTE

The A-610 Bottle Cap has a slightly different configuration than other caps. One hole accepts 3/16" OD tubing, the typical size used with some Waters® systems. The remaining two holes accept 1/8" OD tubing. Unlike the other caps, the A-610 does not have a tapered luer hole. If desired, use our A-628 Plug or A-629 Filter Plug for one of the 1/8" holes.



RELATED PRODUCTS

To ensure a tight seal, use fluoropolymer tubing with these bottle caps (page 55).

Part No.	Description	Qty.
BOTTLE CAPS FOR GL-45, 1 L BOTTLES		
A-610	for 3/16" OD tubing, Red	ea.
A-620	for 1/8" OD tubing, Red	ea.
A-630	for 1/16" OD tubing, Red	ea.
BOTTLE CAPS FOR GL-38, 4 L BOTTLES		
A-622	for 1/8" OD tubing, Black	ea.



Bottle Cap Plugs

Use the A-626 Bottle Cap Plug to seal the third "tapered" luer hole found in most IDEX Health & Science Bottle Caps. Or, use the A-628 Plug to seal any unused 1/16" or 1/8" bottle cap holes.

Alternatively, try the A-627 or A-629 Filter Bottle Cap Plug to cap an unused hole in your bottle cap. The 20 µm stainless steel frit in these products prevents foreign matter from contaminating your solvent while leaving the bottle open to the atmosphere, thus allowing fluid to be pulled out without creating a vacuum (generally not used with sparging applications). All plug bodies are manufactured from ultra-high molecular weight polyethylene (UHMWPE).



A-626
Bottle Cap Plug

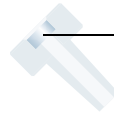

A-629
Filter Bottle Cap Plug

20 µm stainless
steel frit

Part No.	Description	Qty.
BOTTLE CAP PLUGS		
A-626	Bottle Cap Plug for luer hole, UHMWPE	ea.
A-627	Filter Bottle Cap Plug for luer hole, UHMWPE with 20 µm stainless steel frit	ea.
A-628	Bottle Cap Plug for 1/16", 1/8" or 3/16" hole, UHMWPE	ea.
A-629	Filter Bottle Cap Plug for 1/16", 1/8" or 3/16" hole, UHMWPE with 20 µm stainless steel frit	ea.

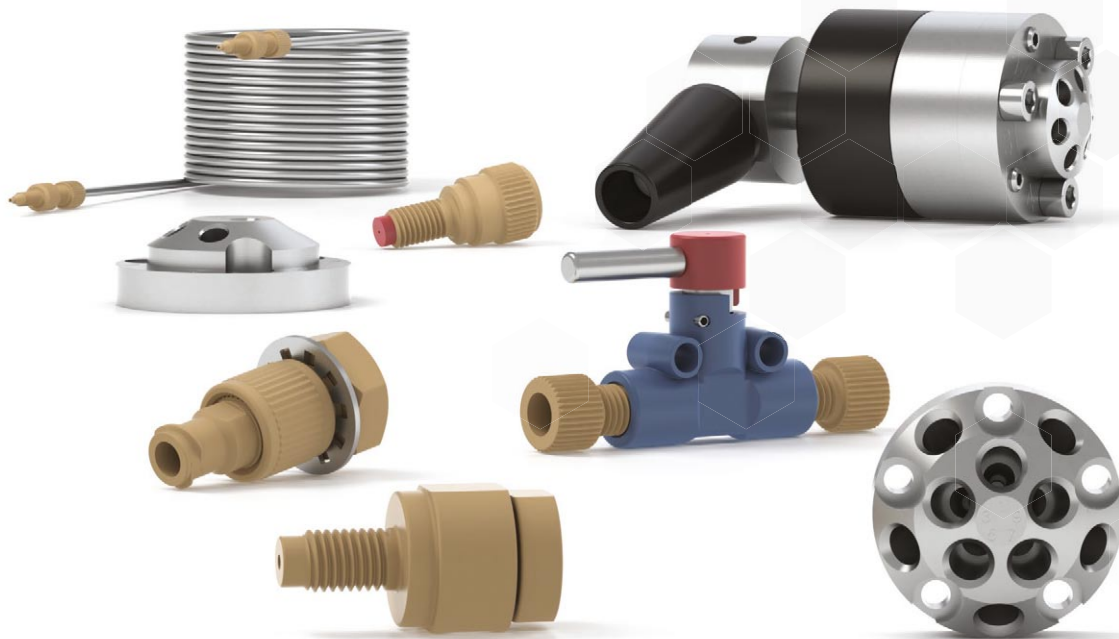

Valves

Our valves are an integral part of advanced fluid-handling solutions for a wide range of analytical instrumentation and clinical diagnostic systems. Our valve options include manual valves for lower frequency use and rotary shear valves that meet the high duty cycle requirements of UHPLC and also come in high and low pressure versions to meet your system requirements. We also offer check valves when there is a need to limit the fluid flow to one direction. Our Back Pressure Regulators products are designed to enhance system performance through outgassing prevention. All of our valve products, components, tools, and accessories are designed keeping our customer's system needs first.

115

VALVE OVERVIEW & FUNCTIONS

115

ROTARY SHEAR VALVES

119

STAND ALONE VALVE PRODUCTS

121

MANUAL VALVES

124

SPARE PARTS

126

VALVE ACCESSORIES

134

FLOW REGULATING VALVES

143

BACK PRESSURE REGULATORS

VALVE OVERVIEW & FUNCTIONS

Valve Module	Flow Configurations	Page
ACTUATED VALVES		
UP TO 15,000 PSI		119
Switching	2-Position, 6-Port 2-Position, 10-Port	
Injection	For Injection, add the appropriately sized Sample Loop to the Switching valves above	
Selection	6-Position, 7-Port	
UP TO 6,000 PSI		119
Switching	2-Position, 6-Port (Analytical and Nano Scale) 2-Position, 10-Port (Analytical and Nano Scale)	
Injection	For Injection, add the appropriately sized Sample Loop to the Switching valves above 2-Position, 6-Port (vertical port)	
Selection	6-Position, 7-Port	
UP TO 125 PSI		119
Switching	2-Position, 6-Port 2-Position, 6-Port (Double 3-Way)	
Selection	6-Position, 7-Port 10-Position, 11-Port	
MANUAL VALVES		
UP TO 9,000 PSI		123
Injection	2-Position, 6-Port (Front-Loading, 9,000 psi)	
UP TO 6,000 PSI		123
Switching	2-Position, 6-Port (Analytical and Micro Scale)	
Injection	2-Position, 6-Port	
Selection	6-Position, 7-Port	
UP TO 1,000 PSI		123
Switching	2-Way, Right Angle 4-Position, 4-Port 3-Way, T-Shape 4-Position, 4-Port 4-Way, Diagonal Flow 4-Position, 4-Port	
Injection	2-Position, 6-Port	
Selection	6-Position, 7-Port	

Rotary Shear Valves

Our Rotary Shear Valves were developed in tandem with the evolution of liquid chromatography, where combinations of elevated system pressures, aggressive chemicals, and ever-diminishing fluid volumes continually challenged system manufacturers who required highly precise fluid control and delivery. Today, many other disciplines utilize Rotary Shear Valves for their versatility, reliability, repeatability, long system uptime, and easy preventive maintenance.

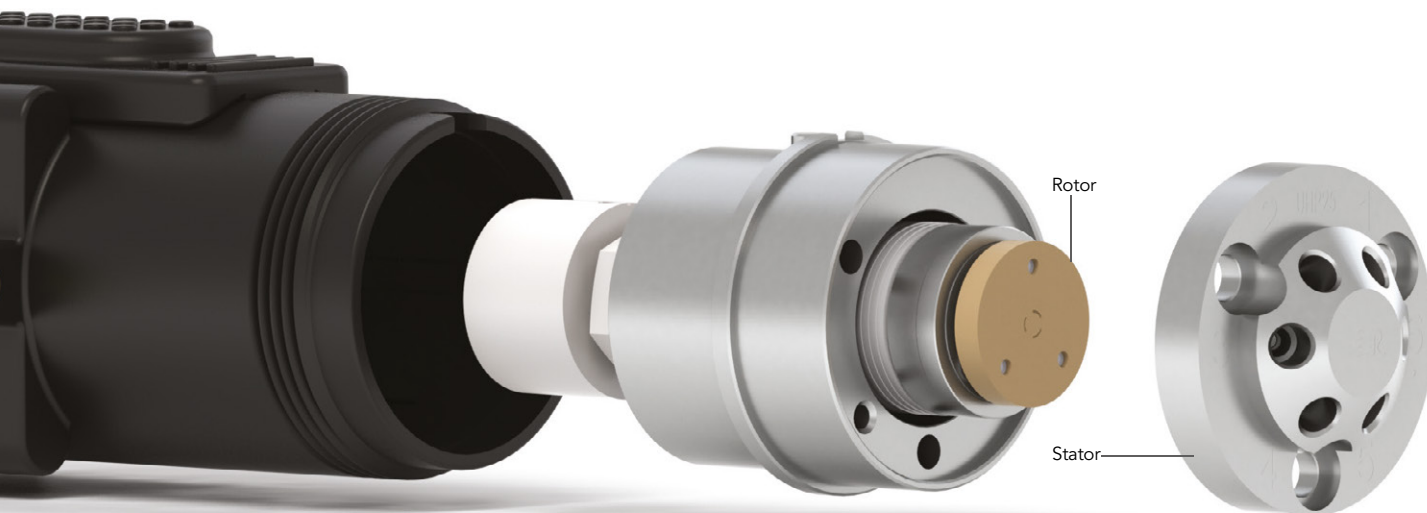

Valve Overview and Functions (Cont.)

Choosing a Rotary Shear Valve

Evaluating some simple variables will assist you in choosing the best valve for your needs.

Identify the Operating Pressure of Your Instrument or Application

Valves are designed to repeatedly deliver specific fluids to different locations in a fluidic circuit. Achieving fluidic precision at 15,000 psi requires different valve-design features than those required to achieve fluidic precision at 100 psi. A wide variety of variables such as valve architectures, metals, polymers, coatings, actuation speeds, and manufacturing techniques have been tested to achieve the fluidic accuracy and precision required for the full array of pressure conditions in life science applications. In this catalog, we define four separate pressure groupings:

Up to 15,000 psi (1,035 bar)	UHPLC/Fast Chromatography
Up to 6,000 psi (410 bar)	HPLC
Up to 1,000 psi (69 bar)	Medium Pressure Applications
Up to 125 psi (8.5 bar)	Low Pressure/ Atmospheric Pressure

Identify the Range of Flow Rates in Your System

Because Rotary Shear Valves have been used most often in chromatography systems, certain flow rate ranges have evolved functionally. However, these ranges can apply to any system, not just chromatography:

- › Micro/Nano Scale — flow rates less than 100 μ L per minute
- › Analytical Scale — flow rates from 100 μ L to 10 mL per minute
- › Prep (or Semi-Prep) Scale — flow rates greater than 10 mL per minute

Decide What You Want the Valve to Do

In this chapter Rotary Shear Valves perform three functions:

- › Switching one or more flow paths to a different destination under pressure
- › Injection into a flowing stream under pressure
- › Selection/distribution of a variety of system liquids by means of a common port
- › Read more about valve functions on page 114.

Identify Whether You Want Automated or Manual Control

An automated valve offers more sophisticated functionality. Choose an automated valve if the application requires fast, consistent flow-stream switching. Some other advantages of automated valves include control options (PC- or instrument-triggered), higher torque operation, valve-position feedback, or very small flow paths.

Choose a manual valve if your application involves low frequency of use, demands operator control, or involves injection of smaller sample volumes. (See page 122 for more on Single Mode vs. Dual Mode operation.)

Identify the Chemical Compatibility Requirements Related to Your Fluids

Consulting the chemical compatibility chart in the Technical Resources section at the back of The IDEX Health & Science Laboratory Products catalog helps identify what valve materials to use — and avoid — in your application. You can also find Chemical Compatibility information at www.idex-hs.com under Materials and Tools.

Identify Fluidic Connection Requirements in Your System

The rotary shear valves in this catalog accommodate one or more of the following tubing outer diameters: 1/8", 1/16", or 1/32".

Effects of Valves & Tubing on Resolution

The effect of tubing on analytical and microscale analyses can be significant. Since dispersion caused by tubing is proportional to the fourth power of diameter, large bore tubing should be avoided when performing analytical scale or microscale analyses. Tubing ID size \leq 0.25 mm (0.010") is recommended.

Consider a system with injection and column switching valves and analytical columns with small-bore connecting tubing. The chromatograms below, made using a typical analytical chromatograph, show these effects. Scheme A is the control (injection valve \rightarrow column \rightarrow detector) with no valve in the system. In Schemes B and C, two model 7060 Six-Position Switching Valves were placed side by side (injection valve \rightarrow valve #1 \rightarrow column \rightarrow valve #2 \rightarrow detector).

The injection valve and detector were connected to these valves by the same tubing used in the control. The extra tubing pieces required to connect the valves to the column were a 10 cm length for valve #1-to-column, and a 35 cm length for column-to-valve #2. The diameters of these tubes are indicated in the experimental details, to the right.

Comparison of Observed Column Plates of Analytical and MicroScale Injection Valves

	7725	8125	Δ
k' = 0.6	2930	5054	72%
k' = 1.5	4653	6904	48%
k' = 7.9	7875	8305	5.0%

UV detector: 1 μ L volume, 4 mm path. Sample volume: 2 μ L, partial-filling method.
Column: 2 mm ID x 100 mm long, 4 μ m C-18. True plates of column = 11,570.

Effects of Valves and Tubing on Resolution

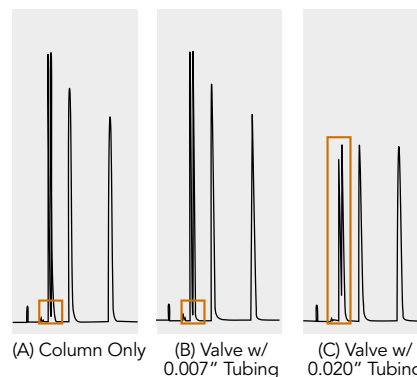

Conclusion: These sequential chromatograms show the effect of adding volume to the flow path through the addition of components.

- (A) Establishes a baseline quality of separation with the minimum volume of liquid in the flow path.
(B) Adding a valve plus smaller-ID tubing, and thereby increasing the liquid volume in the flow path marginally, barely affects the separation. However in
(C) Adding a valve plus larger-ID tubing, thereby increasing the liquid volume in the flow path to a greater degree, distinctly impairs the quality of the separation and the detectable sample.

WHAT IS MAKE-BEFORE-BREAK™, AND WHEN DOES IT MATTER?

Make-Before-Break is a unique design feature of certain dual-mode manual injection valves.

Flow paths of model 7725(i) and 9725(i) with MBB design

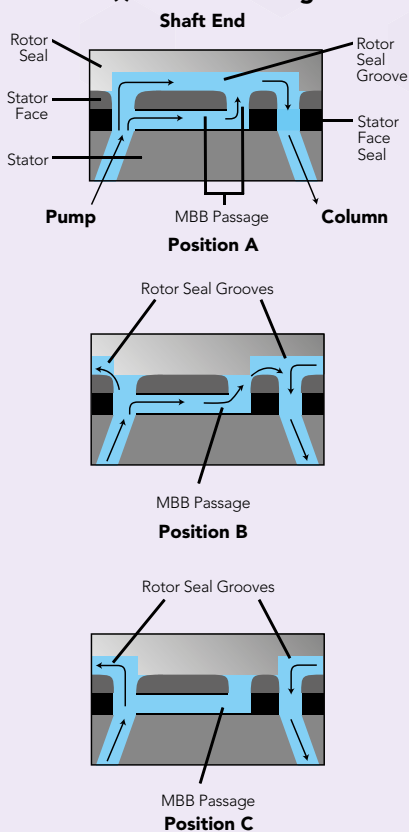

To maintain a constant, desired high-pressure flow, our Make-Before-Break (MBB®) design creates continuous flow between the LOAD and INJECT positions that virtually eliminates pressure transient shock to the system. A passage in the stator face makes a new connection before old connections break. The MBB design — an improvement over bypass-style injectors — does not dilute the sample and is easy to maintain and troubleshoot.

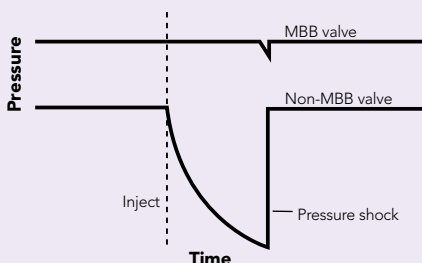

Switching Valves

Switching valves dynamically alternate between two fluid paths without manually disconnecting plumbing. In Chromatography, these valves can be used for column switching, backflushing, sample enrichment, and other techniques. In Diagnostic or Sequencing applications, the switching valve may alternate flow paths to enable back flushing or other fluidic tasks within the instrument.

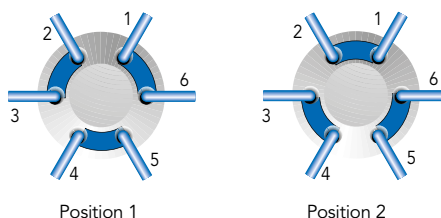

Flow path of Two-Position, Six-Port Switching Valve

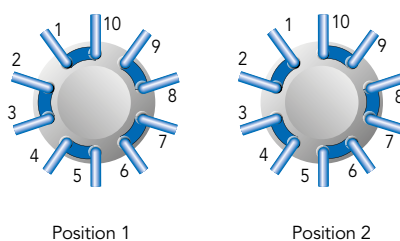

Flow path of Two-Position, Ten-Port Switching Valve

Our switching valves operate between two positions, and may have 6 or 10 ports on the face of the stator (2/6 or 2/10). The flow paths connect ports around the circumference of the stator. The manual switching valves (to 1,000 psi) described on page 123 have different flow path geometry as noted.

Injection Valves

Our injection valves are a form of switching valve. Injection valves can be automated or manual, and they are generally utilized in the two-position, six-port (2/6) configuration and have a sample loop attached.

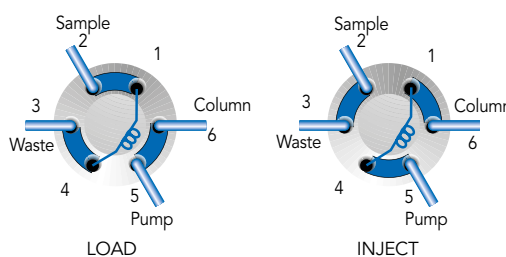

Flow path of Two-Position, Six-Port Injection Valve

The purpose of an Injection valve is to introduce a sample into a flowing stream of liquid. Some Switching valves become Injection valves by the addition of a Sample Loop (a defined length of tubing and fittings configured to match the angle of the valve ports). Sample is loaded and held in the loop until injection is triggered, either manually or automatically.

Injection valves are classified as either Single or Dual Mode based on how the Sample Loop can be filled. A Single Mode Injection valve requires complete filling of the sample loop and is configured for Rear loading, generally in an auto-sample configuration. A Dual Mode Injection valve allows either partial or complete filling of the loop, and introduces sample by syringe through the needle port built into the valve shaft. Complete filling of the sample loop in both the Dual and Single Mode Injection valves provides greater repeatability injection to injection. (See the Application Note, page 131 for greater detail on partial vs. complete loop filling.)

Valve Overview and Functions (Cont.)

Selection Valves

Selection valves enable discrete connections among multiple system liquids (mobile phase, reagents, buffers) by means of a common port (inlet or outlet) connected to a number of different reciprocal ports. In Diagnostic or Sequencing applications, the selection valve alternates between different reagents or sample streams.

Numerous configurations exist among selection valves (e.g., 6-position 7-port, or 10-position 11-port), but these valves typically operate between more than two positions. The ports are usually spaced radially, or outward in some manner around the center port of the stator.

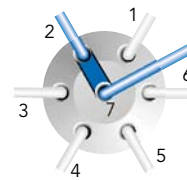

Flow path of Six-Position, Seven-Port Selector Valve



APPLICATION NOTE

Six column selection using two selection valves.

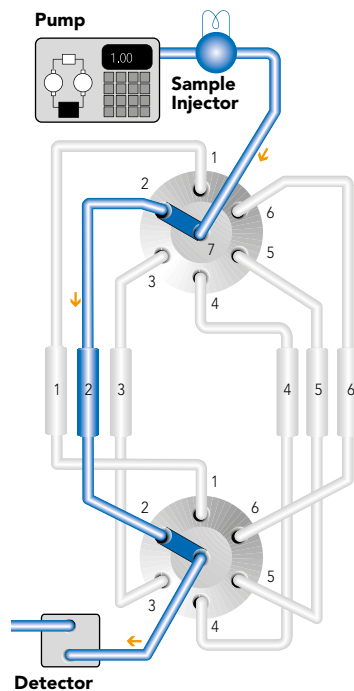



Stand Alone Valve Products

An automated valve offers more sophisticated functionality. Choose an automated valve if the application requires fast, consistent flow-stream switching. Some other advantages of automated valves include control options (PC- or instrument-triggered), higher torque operation, valve-position feedback, or very small flow paths.

MX Series II

› **MXT** to 15,000 psi
(1,035 bar)



› **MXP** to 6,000 psi
(410 bar)



› **MXX** to 125 psi
(8.5 bar)

Add our MX Series II™ actuated valves to your existing instrument or use in stand-alone lab configurations. MX valves can be controlled remotely or operated manually using the push-button front panel with LED position indicator. MX valves connect to your instrument or PC through contact closure, BCD, serial port, or USB. Commands can be sent to the MX valves using your chromatography software or the included proprietary software for timed-events programmability.

Available flow rates include options for Analytical, Micro/Nano, or Semi-Prep in a range of pressure capabilities. Valve liquid ends are available in materials chosen to be chemically inert and biocompatible. Routine maintenance using authorized RheBuild® kits (page 124) or — for the higher-pressure MXP and MXP valves — the Rapid Replacement Pods™ (page 120) assures optimal performance.

Part No.	Description	Ports, Connections	Wetted Material	Rapid Replacement Pod	Qty.
ACTUATED VALVES UP TO 15,000 PSI (1,035 BAR)					
SWITCHING					
MXT715-000	2-Position, 6-Port	10-32 Ports for 1/16" OD Tubing	UltraLife	PD715-000	ea.
MXT715-102	2-Position, 10-Port	10-32 Ports for 1/16" OD Tubing	UltraLife	PD715-102	ea.
INJECTION For Injection, add the appropriately sized Sample Loop to the Switching valves above					
SELECTION					
MXT715-105	6-Position, 7-Port	10-32 Ports for 1/16" OD Tubing	UltraLife	PD715-105	ea.
All of these MXT valves include a set of 1/16" fittings. Replacement Fittings for MXT valves can be located on page 133.					
ACTUATED VALVES UP TO 6,000 PSI (410 BAR)					
SWITCHING					
MXP7900-000	2-Position, 6-Port	10-32 Ports for 1/16" OD Tubing	DuraLife®*	PD7900	ea.
MXP7960-000	2-Position, 10-Port	10-32 Ports for 1/16" OD Tubing	DuraLife	PD7960	ea.
MXP7980-000	2-Position, 6-Port, Nano, 5,000 psi (345 bar)	M4 Ports for 1/32" OD Tubing	DuraLife II	PD7980	ea.
MXP7986-000	2-Position, 10-Port, Nano, 5,000 psi (345 bar)	M4 Ports for 1/32" OD Tubing	DuraLife II	PD7986	ea.
MXP9900-000	2-Position, 6-Port, Biocompatible, 5,000 psi (345 bar)	10-32 Ports for 1/16" OD Tubing	PEEK	PD9900	ea.
MXP9960-000	2-Position, 10-Port, Biocompatible, 5,000 psi (345 bar)	10-32 Ports for 1/16" OD Tubing	PEEK	PD9960	ea.
INJECTION For Injection, add the appropriately sized Sample Loop to the Switching valves above					
MXP7920-000	2-Position, 6-Port, Vertical Port	10-32 Ports for 1/16" OD Tubing	DuraLife	PD7920	ea.
SELECTION					
MXP7970-000	6-Position, 7-Port	10-32 Ports for 1/16" OD Tubing	DuraLife II**	PD7970	ea.
* DuraLife is a proprietary material combination of SST and an advanced polymer.					
** DuraLife II is a proprietary material combination consisting of Titanium and an advanced polymer.					
All of these MXP valves include a set of 1/16" fittings. Replacement Fittings for MXP valves can be located on page 133.					
ACTUATED VALVES UP TO 125 PSI (8.5 BAR)					
SWITCHING					
MXX777-601	2-Position, 6-Port	Accepts Either 1/16" or 1/8" Tubing	RPC-7*	1/16" and 1/8"	ea.
MXX777-603	2-Position, Double Three Way	Accepts Either 1/16" or 1/8" Tubing	RPC-7	1/16" and 1/8"	ea.
MXX777-612	2-Position, 6-Port, Large Bore	Accepts Either 1/16" or 1/8" Tubing	RPC-7	1/16" and 1/8"	ea.
SELECTION					
MXX777-605	6-Position, 7-Port	Accepts Either 1/16" or 1/8" Tubing	RPC-7	1/16" and 1/8"	ea.
MXX777-616	6-Position, 7-Port, Large Bore	Accepts Either 1/16" or 1/8" Tubing	RPC-7	1/16" and 1/8"	ea.
MXX778-605	10-Position, 11-Port	Accepts Either 1/16" or 1/8" Tubing	RPC-7	1/16" and 1/8"	ea.

* RPC-7 Proprietary Polymer Combination.

All of these MXX valves include a set of 1/16" and 1/8" ferrules. Replacement Fittings for MXX valves can be located on page 133.



Rapid Replacement Pods™

For IDEX Health & Science MX Series II Valves

- › Zero downtime maintenance
- › Improves lab throughput

To help keep your instrument online and performing at maximum precision, select the exact Rapid Replacement Pod for your higher pressure MX Series II valves. Replacement pods are easily exchanged as part of scheduled preventive maintenance, or in an emergency, a pod can be substituted quickly while the original is examined and maintained at your convenience. The pod kit contains complete instructions for removal and replacement.



Part No.	Description	For Valve Part No.	Qty.
TO 15,000 PSI (1,035 BAR)			
SWITCHING			
PD715-000	Rapid Replacement Pod	MXT715-000	ea.
PD715-102	Rapid Replacement Pod	MXT715-102	ea.
SELECTION			
PD715-105	Rapid Replacement Pod	MXT715-105	ea.
UP TO 6,000 PSI (410 BAR)			
SWITCHING			
PD7900	Rapid Replacement Pod	MXP7900-000	ea.
PD7960	Rapid Replacement Pod	MXP7960-000	ea.
PD7980	Rapid Replacement Pod	MXP7980-000	ea.
PD7986	Rapid Replacement Pod	MXP7986-000	ea.
PD9900	Rapid Replacement Pod	MXP9900-000	ea.
PD9960	Rapid Replacement Pod	MXP9960-000	ea.
INJECTION			
PD7920	Rapid Replacement Pod	MXP7920-000	ea.
SELECTION			
PD7970	Rapid Replacement Pod	MXP7970-000	ea.



Manual Valves

Choose a manual valve if your application involves low frequency of use, demands operator control, or involves injection of smaller sample volumes.



7725i
Manual Injection Valve
Up to 9,000 psi (600 bar)



7060
Manual Switching Valve
Up to 7,000 psi (483 bar)



3725i-038
Manual Switching Valve
Up to 7,000 psi (483 bar)



NOTE

Manual Switching Valve Options

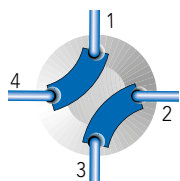

4-Way Diagonal Flow Switching Valves
(V-100D, V-101D)

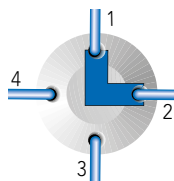

Right Angle Flow Switching Valves
(V-100L, V-101L)

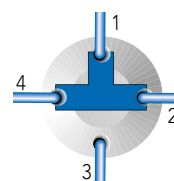

3-Way Flow Switching Valves
(V-100T, V-101T)



V-101L
Manual Switching Valve
Up to 1,000 psi (69 bar)

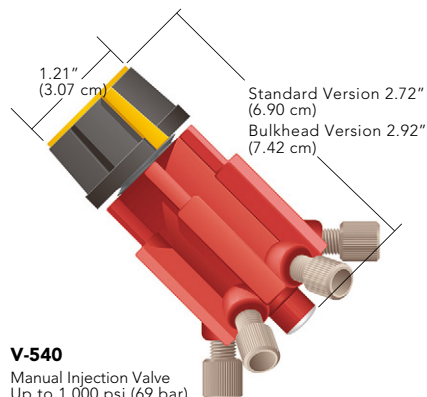

V-540
Manual Injection Valve
Up to 1,000 psi (69 bar)

Manual Valves (Cont.)

APPLICATION NOTE

Switching Valve Applications

Protect sensitive system components (such as a column) during a cleaning cycle with our Diagonal Flow Switching Valve ("D"). This valve eliminates the need to remove, plug and reconnect a low pressure column (see below).

› A typical application for a Right Angle Flow Switching Valve ("L") is column switching, allowing two columns to use one detector. Detector switching is another common application for this valve (see below). Plug off the extra port with the included plug.

› Your detector switching application may require the flexibility of routing the column effluent to both detectors simultaneously while retaining the ability to isolate each detector. Use our 3-Way Flow Switching Valve ("T"), plugging off the fourth port with the included plug.

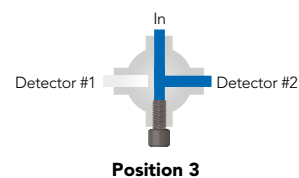
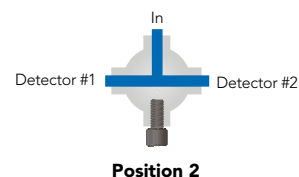
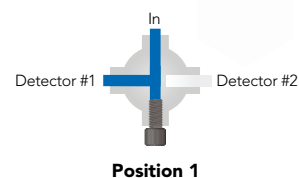
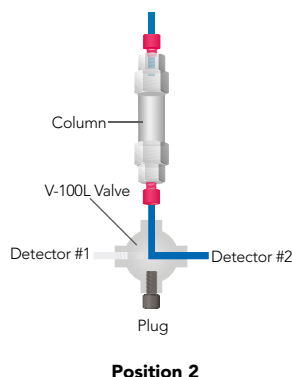
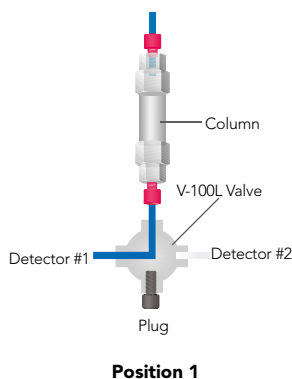
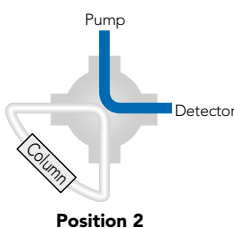
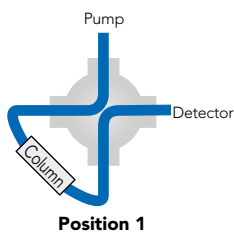

Characteristics of Manual Sample Injection Valves

Type & Capabilities	Scale	Partial Filling Volumes (Range)	Sample Loop Sizes (Range)	Wetted Materials	Max. psi (bar) ¹	Max. T (°C)	MBB ²	Model ³
Dual Mode Can load the loop by two methods: 1) Partial filling – syringe determines volume without wasting sample 2) Complete filling – loop determines volume by over filling loop	Analytical	1 µL–2.5 mL	2 µL–5.0 mL	316 SST, Vespel® PEEK, ETFE, ceramic	7,000 (483)	80°	Yes	7725, 7725i
		1 µL–5.0 mL	2 µL–10 mL		5,000 (340)	50°	Yes	9725, 9725i
	Micro	0.1 µL–500 µL	5 µL–1.0 mL	316 SST, PEEK, Vespel, ceramic	7,000 (483)	80°	No	8125
Single Mode Can load the loop by one method: Complete filling — loop determines volume by over filling loop	Preparative	100 µL–10 mL	2.0 mL–20 mL	316 SST, PEEK PEEK	5,000 (340)	50°	Yes	3725(i)-038, 3725i
		Analytical	Not Applicable		5 µL–5.0 mL 5 µL–10 mL	316 SST, Vespel PEEK, ETFE, Ceramic	7,000 (483) 5,000 (340)	150° 50°

SST = Stainless Steel

¹ This is the maximum pressure to which the valve can be adjusted. Some models are shipped from the factory set for lower pressures.

² MBB (Make-Before-Break™) is a design that provides uninterrupted flow when switching between LOAD and INJECT. MBB also greatly reduces transient pressure shocks.

³ Models with an "i" suffix have a built-in position sensing switch. Models 8125 and 9010 also have a built-in switch.



SPECIFICATIONS & DETAILS

Part No.	Stator Passage Diameter	Factory Set Pressure	Maximum Field Set Pressure	Maximum Temperature (°C)
3000 (PEEK)	1.0 mm (0.040")	3,000 psi (207 bar)	4,000 psi (276 bar)	50°
7000, 7010 (SST)	0.6 mm (0.024")	5,000 psi (340 bar)	7,000 psi (483 bar)	150°
7000L (SST)	1.0 mm (0.040")	3,000 psi (207 bar)	5,000 psi (340 bar)	150°
7030 (SST)	0.6 mm (0.024")	5,000 psi (340 bar)	7,000 psi (483 bar)	150°
7030L (SST)	1.0 mm (0.040")	3,000 psi (207 bar)	5,000 psi (340 bar)	150°
7060 (SST)	0.4 mm (0.016")	5,000 psi (340 bar)	7,000 psi (483 bar)	80°

SST = Stainless Steel

Manual Valves

Part No.	Description	Tubing/Fitting Size	Wetted Material	Configuration	Qty.
MANUAL VALVES UP TO 9,000 PSI (600 BAR)					
INJECTION					
7725i-188	2-Position, 6-Port, 9,000 psi (600 bar)	10-32 Ports for 1/16" OD Tubing	Stainless Steel, PEEK, Ceramic	Front loading	ea.
MANUAL VALVES UP TO 6,000 PSI (410 BAR)					
SWITCHING					
3000	2-Position, 6-Port, Prep Scale	5/16-24 Ports for 1/8" OD Tubing	PEEK	—	ea.
7000	2-Position, 6-Port, Large Bore	10-32 Ports for 1/16" OD Tubing	Stainless Steel & Vespel®	—	ea.
7000L	2-Position, 6-Port, Large Bore	10-32 Ports for 1/16" OD Tubing	Stainless Steel & Vespel	—	ea.
7030	2-Position, 6-Port	10-32 Ports for 1/16" OD Tubing	Stainless Steel & Vespel	Double 3-Way	ea.
7030L	2-Position, 6-Port, Large Bore	10-32 Ports for 1/16" OD Tubing	Stainless Steel & Vespel	Double 3-Way	ea.
INJECTION*					
7010	2-Position, 6-Port Single Mode	10-32 Ports for 1/16" OD Tubing	Stainless Steel & Vespel	20 µL*	ea.
9010	2-Position, 6-Port Single Mode (Switching, Injection)	10-32 Ports for 1/16" OD Tubing	PEEK, ETFE, Ceramic	20 µL*	ea.
3725-038	2-Position, 6-Port, Prep Scale Dual Mode	5/16-24 Ports for 1/8" Tubing	Stainless Steel & PEEK	10 mL*	ea.
3725i	2-Position, 6-Port, Prep Scale Dual Mode with Switch	5/16-24 Ports for 1/8" Tubing	PEEK	10 mL*	ea.
3725i-038	2-Position, 6-Port, Prep Scale Dual Mode with Switch	5/16-24 Ports for 1/8" Tubing	Stainless Steel & PEEK	10 mL*	ea.
7725	2-Position, 6-Port, Analytical Scale Dual Mode	10-32 Ports for 1/16" OD Tubing	Stainless Steel, Ceramic, Vespel	20 µL*	ea.
7725i	2-Position, 6-Port, Analytical Scale Dual Mode with Switch	10-32 Ports for 1/16" OD Tubing	Stainless Steel, Ceramic, Vespel	20 µL*	ea.
8125**	2-Position, 6-Port, Micro Scale Dual Mode with Switch	10-32 Ports for 0.020" (0.5 mm) or 1/16" Tubing	Stainless Steel, Ceramic, Vespel	5 µL*	ea.
9725	2-Position, 6-Port, Analytical Scale Dual Mode	10-32 Ports for 1/16" OD Tubing	PEEK, ETFE, Ceramic	20 µL*	ea.
9725i	2-Position, 6-Port, Analytical Scale Dual Mode with Switch	10-32 Ports for 1/16" OD Tubing	PEEK, ETFE, Ceramic	20 µL*	ea.
SELECTION					
7060	6-Position, 7-Port	10-32 Ports for 1/16" OD Tubing	Stainless Steel & Vespel	6-Way	ea.

* Ships with a sample loop of indicated volume attached to ports 1 and 4.

** The 8125 requires special ferrules for 0.020" (0.5 mm) tubing. 8125-084-0.5 mm ferrule for 8125; 8125-086-0.5 mm ferrule for 8125 — 4-pk.

Part No.	Description	Tubing/Fitting Size	Wetted Material	Configuration	Includes	Qty.
SWITCHING						
V-100D	4-Position, 4-Port, 500 psi (34 bar)	1/4-28 Ports for 1/16" OD Tubing	PEEK, PTFE	Double Diagonal	*	ea.
V-101D	4-Position, 4-Port, Bulkhead, 500 psi (34 bar)	1/4-28 Ports for 1/16" OD Tubing	PEEK, PTFE	Double Diagonal	*	ea.
V-100L	4-Position, 4-Port, 500 psi (34 bar)	1/4-28 Ports for 1/16" OD Tubing	PEEK, PTFE	Right-Angle "L"	**	ea.
V-101L	4-Position, 4-Port, Bulkhead, 500 psi (34 bar)	1/4-28 Ports for 1/16" OD Tubing	PEEK, PTFE	Right-Angle "L"	**	ea.
V-100T	4-Position, 4-Port, 500 psi (34 bar)	1/4-28 Ports for 1/16" OD Tubing	PEEK, PTFE	Single "T"	***	ea.
V-101T	4-Position, 4-Port, Bulkhead, 500 psi (34 bar)	1/4-28 Ports for 1/16" OD Tubing	PEEK, PTFE	Single "T"	***	ea.
INJECTION For Injection, add the appropriately sized Sample Loop to the Switching valves above						
V-450	2-Position, 6-Port, 1,000 psi (69 bar)	1/4-28 Ports for 1/16" OD Tubing	Polyimide, PTFE	Injection	(6) XP-235	ea.
V-451	2-Position, 6-Port, Bulkhead Version, 1,000 psi (69 bar)	1/4-28 Ports for 1/16" OD Tubing	Polyimide, PTFE	Injection	(6) XP-235	ea.
V-540	2-Position, 6-Port, 1,000 psi (69 bar)	1/4-28 Ports for 1/8" OD Tubing	Polyimide, PTFE	Injection	(6) XP-335	ea.
V-541	2-Position, 6-Port, Bulkhead Version, 1,000 psi (69 bar)	1/4-28 Ports for 1/8" OD Tubing	Polyimide, PTFE	Injection	(6) XP-335	ea.
SELECTION						
V-240	6-Position, 7-Port, 1,000 psi (69 bar)	1/4-28 Ports for 1/16" OD Tubing	Polyimide, PTFE	Multi-port Selection	(6) XP-235	ea.
V-241	6-Position, 7-Port, Bulkhead Version, 1,000 psi (69 bar)	1/4-28 Ports for 1/16" OD Tubing	Polyimide, PTFE	Multi-port Selection	(6) XP-235	ea.
V-340	6-Position, 7-Port, 1,000 psi (69 bar)	1/4-28 Ports for 1/8" OD Tubing	Polyimide, PTFE	Multi-port Selection	(6) XP-335	ea.
V-341	6-Position, 7-Port, Bulkhead Version, 1,000 psi (69 bar)	1/4-28 Ports for 1/8" OD Tubing	Polyimide, PTFE	Multi-port Selection	(6) XP-335	ea.

* (4) P-218BLK, (4) P-240.

** (4) P-218BLK, (4) P-240, (1) P-309.

*** (4) P-218BLK, (4) P-240, (1) P-309.

Spare Parts

We offer a full line of genuine spare parts to assist with your use of our valve products. We offer RheBuild® Kits designed for specific valve models. Rotor Seal and Stators are commonly replaceable parts.



Rotor Seals & Stators

The rotor seal is the polymeric disc that makes a high pressure seal against the stator or stator face seal. The seal wears with use and is one of the only parts that may need routine replacement.

Stators are available in 316 stainless steel, PEEK and proprietary materials. Typically, stators need replacement only if the ports or sealing surfaces become damaged. Avoid damage from use of improper injection needles by referring to the "Using Proper Syringe Needles" Application Note on page 130.

Please Note: Rotor seals for MX Series II™ Modules are available in RheBuild® Kits on this page. Stators for MX Series II Modules are available on this page. MX (Series I) Module rotor seals are available in RheBuild Kits on this page.

RheBuild® Kits

RheBuild Kits are available for most valve products. Included in each individualized RheBuild Kit are all parts, tools, and instructions to maintain precision performance of your particular product. RheBuild Kits eliminate individual part ordering.



APPLICATION NOTE

How to Select the Right Rotor Seal

The standard rotor seal in many of our manual valves is made from a Vespel® blend. This polyimide has low wear and high chemical resistance. Vespel tolerates a pH range of 0 to 10. Solutions more basic than pH 10 attack Vespel which damages the rotor seal. If you use any solutions above pH 10, our experts recommend a PEEK blend rotor seal. PEEK offers a high chemical resistance and versatility, and will tolerate the entire pH range from 0 to 14. ETFE blend rotor seals are appropriate for use in applications where PEEK is not generally acceptable, such as when methylene chloride or DMSO in higher concentrations is being used.

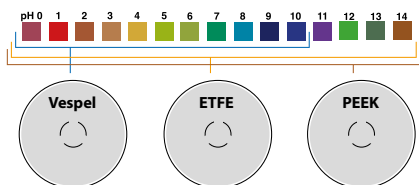

APPLICATION NOTE

How to Avoid Pressure Transients

Air in the sample loop can cause an instantaneous system pressure drop that eventually returns to a normal level. Air causes the pressure to drop when the injector moves from the LOAD to the INJECT position. When large sample loops ($\geq 100 \mu\text{L}$) are partially loaded, air present in the needle port tube is pushed into the sample loop (see Figure 1). Air can also enter the sample loop from siphoning which occurs when the vent line is higher than the injection port. In either case, upon injection, the system pressure collapses the air bubble, causing pressure to drop momentarily.

A pressure drop in the system caused by air results in changes in retention time, artifact peaks, and affects column performance.

Avoid pressure drops by removing the air in the needle port tube. Do this by flushing about 1 mL of mobile phase with a luer syringe with needle port cleaner. Keep the needle port tube filled with mobile phase by occasional flushing. Adjust the vent line(s) so the outlet is at the same horizontal level as the needle port (see Figure 2).

For additional injection troubleshooting, refer to our Troubleshooting Guide for HPLC Injection Problems. You may download the Guide from the IDEX Health & Science web site: www.idex-hs.com under Education & Tools.

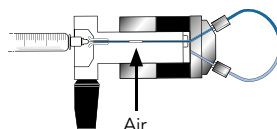

Figure 1 Air present in the needle port tube is pushed by the syringe during loading into the sample loop

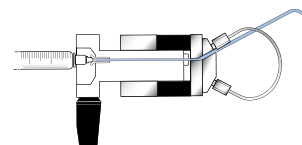
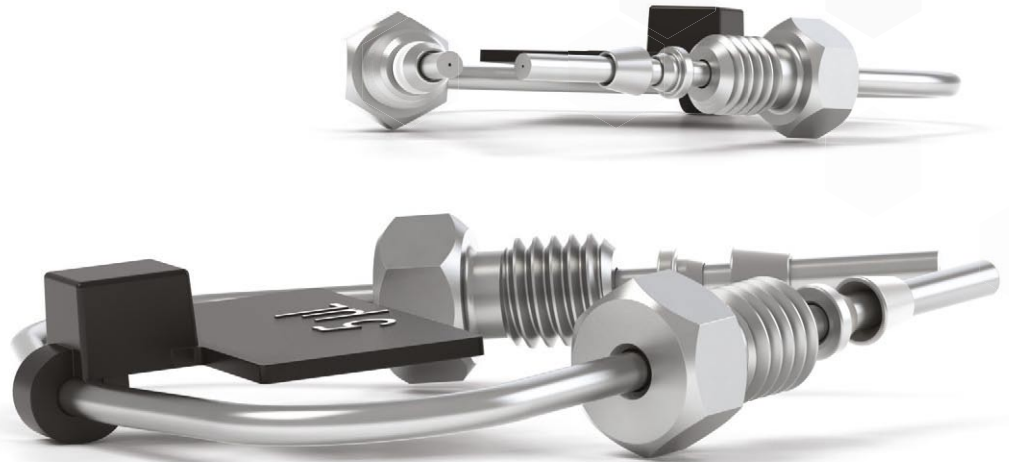

Figure 2 Pathway of the flushing mobile phase using the Needle Port Cleaner, Part # 7125-054 (see page 131) when the injector is in INJECT

Part No.	For Valve Model No.	Description	Qty.
VESPEL BLEND ROTOR SEALS			
7000-016	7000L, 7040L	Vespel Rotor Seal	ea.
7010-039	7010, 7000, 7040	Vespel Rotor Seal	ea.
7030-003	7030, 9030	Vespel Rotor Seal	ea.
7030-014	7030L	Vespel Rotor Seal	ea.
7060-070	7060, 7066	Vespel Rotor Seal	ea.
7060-064	7060L	Vespel Rotor Seal	ea.
7125-047	7125, 7725, 9725	Vespel Rotor Seal	ea.
7410-038	7410	Vespel Rotor Seal	ea.
7413-013	7413	Vespel Rotor Seal	ea.
8125-038	8125	Vespel Rotor Seal	ea.
ETFE BLEND ROTOR SEALS			
7010-071	7010, 7010-087, 7000, 7040	ETFE Rotor Seal	ea.
7030-015	7030, 9030	ETFE Rotor Seal	ea.
7060-074	7060, 7066, 9060	ETFE Rotor Seal	ea.
7125-079	7125, 7125-081, 7725	ETFE Rotor Seal	ea.
8125-097	8125	ETFE Rotor Seal	ea.
9010-051	9010	ETFE Rotor Seal	ea.
9125-082	9125, 9725	ETFE Rotor Seal	ea.
PEEK BLEND ROTOR SEALS			
3725-018	3725, 3725-038	PEEK Rotor Seal	ea.
9010-065	7000, 7010, 9010	PEEK Rotor Seal	ea.
8125-119	8125	PEEK Rotor Seal	ea.
9125-095	7125, 7725, 9125, 9725	PEEK Rotor Seal	ea.
STATORS FOR MX SERIES II MODULES			
7123-548	MXT715-000	Stator	ea.
7123-550	MXT715-105	Stator	ea.
7123-568	MXT715-102	Stator	ea.
7770-229	MXP7920-000	Stator	ea.
7980-004	MXP7980-000	Stator	ea.
7986-004	MXP7986-000	Stator	ea.
7900-146	MXP9900-000	Stator	ea.
7900-179	MXP7900-000	Stator	ea.
7900-183	MXP7970-000	Stator	ea.
7960-014	MXP7960-000	Stator	ea.
9960-002	MXP9960-000	Stator	ea.
STATORS FOR OTHER IDEX HEALTH & SCIENCE VALVES			
3725-006	3725, 3710-038, 3000-038 and 3030-038	Stator	ea.
7010-069	7000L, 7030L, 7040L	Stator	ea.
7010-040	7010, 7125, 7000, 7030 and 7040	Stator	ea.
7060-039	7060 and 7066	Stator	ea.
7060-065	7060L, EV501-100	Stator	ea.
7123-047	PR/EV500-100	Stator	ea.
7123-127	PR/EV750-107	Stator	ea.
7123-128	PR/EV700-107	Stator	ea.
7123-142	PR/EV500-104, EV501-104	Stator	ea.
7123-145	PR/EV550-104, EV551-104	Stator	ea.
7123-147	PR/EV550-100	Stator	ea.
7123-148	PR/EV500-101	Stator	ea.
7123-149	PR/EV550-101	Stator	ea.
7123-180	PR703-100 and EV700-105	Stator	ea.
7123-221	PR753-100 and EV750-105	Stator	ea.
7123-223	PR/EV700-112	Stator	ea.
7410-041	7410 and 7413	Stator	ea.
7520-030 (inlet)	7520	Stator	ea.
7520-035 (outlet)	7520	Stator	ea.
7650-002	PR/EV700-102	Stator	ea.
7725-010	7725(i)	Stator	ea.
7750-070	7750	Stator	ea.
7750-038	PR/EV700-100	Stator	ea.
8125-098	8125	Stator	ea.
9125-043	9125, 9010, 9030 and 9725(i)	Stator	ea.
9650-009	PR/EV750-102	Stator	ea.
9750-021	PR/EV750-100	Stator	ea.

Part No.	Description	Qty.
RHEBUILD KITS FOR MX SERIES II™ VALVES		
7150-999	RheBuild Kit for MXT715-000 (includes 2 rotor seals)	ea.
7152-999	RheBuild Kit for MXT715-102 (includes 2 rotor seals)	ea.
7155-999	RheBuild Kit for MXT715-105 (includes 2 rotor seals)	ea.
7920-999	RheBuild Kit for MXP7920-000 and MXP7900-000	ea.
7960-999	RheBuild Kit for MXP9960-000 (includes rotor seal and stator face seal)	ea.
7961-999	RheBuild Kit for MXP7960-000	ea.
7970-999	RheBuild Kit for MXP7970-000	ea.
79801-999	RheBuild Kit for MXP7980-000	ea.
79861-999	RheBuild Kit for MXP7986-000	ea.
7900-999	RheBuild Kit for MXP9900-000 (includes rotor seal and stator face seal)	ea.
RHEBUILD KITS FOR MANUAL VALVES		
3725-999	RheBuild Kit for models 3725, 3725i, 3725-038, 3735i-038	ea.
7010-997	RheBuild Kit including Stator for model 7010	ea.
7010-998	RheBuild Kit, pH Upgrade Kit for model 7000	ea.
7010-999	RheBuild Kit for model 7010 and 7010-type Valves	ea.
7125-999	RheBuild Kit for models 7125 and 7126	ea.
7410-999	RheBuild Kit for model 7410	ea.
7520-999	RheBuild Kit for models 7520 and 7526 (includes inlet stator and seal)	ea.
7725-999	RheBuild Kit for models 7725 and 7725i	ea.
7788-999	RheBuild Kit for model 7725i-188	ea.
8125-999	RheBuild Kit for models 8125 and 8126	ea.
9010-999	RheBuild Kit for model 9010	ea.
9125-999	RheBuild Kit for models 9125 and 9126	ea.
9725-999	RheBuild Kit for models 9725 and 9725i; 7725(i) pH upgrade kit	ea.
RHEBUILD KITS FOR MX SERIES I™ VALVES		
7900-999	RheBuild Kit for models MX7900-000, MX7925-000, MX9900-000, MX9925-000	ea.
7960-999	RheBuild Kit for model MX7960-000	ea.
7980-999	RheBuild Kit for model MX7980-000	ea.
7984-999	RheBuild Kit for model MX7984-000	ea.
7986-999	RheBuild Kit for model MX7986-000	ea.
RHEBUILD KITS FOR LABPRO™ & EV AUTOMATED FLUIDIC INSTRUMENTS		
1006-999	RheBuild Kit for model PR/EV100-106	ea.
5001-999	RheBuild Kit for models PR/EV500-101 and PR/EV550-101	ea.
5100-999	RheBuild Kit for models PR/EV500-100 and PR/EV550-100	ea.
5104-999	RheBuild Kit for models PR/EV500-104 and PR/EV550-104	ea.
7004-999	RheBuild Kit for models PR/EV700-104 and PR/EV750-104	ea.
7112-999	RheBuild Kit for models PR/EV700-112 and PR/EV750-112	ea.
7501-999	RheBuild Kit for models PR/EV700-100 and PR/EV750-100	ea.
7502-999	RheBuild Kit for models PR/EV700-102 and PR/EV750-102	ea.
7507-999	RheBuild Kit for models PR/EV700-107 and PR/EV750-107	ea.
7531-999	RheBuild Kit for models PR703-100 and PR753-100	ea.



VALVE ACCESSORIES

Our valve accessories include a variety of products that work with and are specific to our valve mechanics. From Sample Loops, driver boards, or mounting brackets we offer a wide array of accessories to meet your system requirements. We also include tools that work specifically with our valves and valve components.

- 127** STAINLESS STEEL SAMPLE LOOPS
- 128** PEEK SAMPLE LOOPS
- 131** SUCTION NEEDLE ADAPTER
- 132** INJECTION PORT ADAPTERS
- 133** WRENCHES, BRACKETS, & REPLACEMENT FITTINGS



Stainless Steel Sample Loops



APPLICATION NOTE

How to Properly Install Sample Loops: Stainless Steel

Stainless steel sample loops are supplied with fittings that are not swaged onto the tube. It is important that the loop be completely bottomed in the injector port before the ferrule is swaged onto the tube. The depth of the tubing holes may vary slightly from port to port and from valve to valve. A fitting made up in one port may leave a small cavity in another port. The cavity causes high dispersion and peak distortion such as fronting, tailing, or broadening. It is good practice to label loop ends so they will be replaced in the same, respective ports that were used in swaging the ferrules. Hint: swaging ferrules separately on each side, into each respective valve port makes loop installation easier.

To install the sample loop:

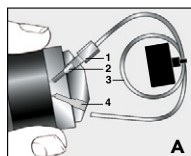

- 1 Take one end of the loop and place the nut (1) and ferrule (2) onto the tubing (3) with the threaded portion of the nut and tapered portion of the ferrule toward the end. See Figure A.

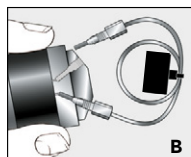

- 2 Insert the tubing into port (4). Confirm that the tubing is bottomed in the valve port as shown in Figure A.

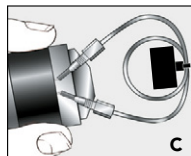

- 3 While firmly pressing down on the tubing, hand-tighten the nut as tight as possible.

- 4 With the IDEX Wrench (page 51), designed especially for fittings, tighten one quarter turn past finger tight. Remove the loop to confirm the ferrule is swaged onto the tube.

- 5 Repeat steps a-d with the other end of the loop while the swaged end remains outside the valve port. See Figure B.

- 6 Reinstall each end of the loop to their respective ports. See Figure C.

Figure 1 Cut-away view of stainless steel sample loop installation

These high quality stainless steel sample loops have burr-free, square-cut ends to ensure a flush connection to valve ports. The size designations of loops are nominal. The actual volumes can differ from the theoretical designations because the ID tolerance varies depending on the tubing tolerance of the metal tubing bore. Accuracy of large metal loops (1.0 mm, 0.040" bore) is about $\pm 5\%$, intermediate loops (0.5 mm, 0.020" bore) $\pm 10\%$, and small loops (0.2 mm, 0.007" bore) $\pm 30\%$.

Since both standards and unknowns are usually analyzed using the same sample loop, knowledge of the actual, accurate volume is rarely needed. If the sample loop volume must be known, it is best to calibrate the loop in place on the valve so the flow passages in the valve are also taken into account. An alternative to calibration is to use a dual mode injector and partial-filling method of loading. See the "Sample Loop Loading" Application Note on page 131.

Model 7725 Injector loops are not interchangeable with loops for the model 7125. The port angle for the 7725 is 30° whereas the port angle for the 7125 is 20° requiring the loops to have a different shape. Model 8125 Micro-Scale Sample Injector requires special loops in the 5.0 μL to 50 μL range. The 8125 sample loops are made with 0.5 mm (0.020") OD tubing.

Part No.	Volume	Tubing	Qty.
STAINLESS STEEL LOOPS FOR 7125, 7010 INJECTION VALVES (DO NOT USE FOR 7725)			
7020	5 μL Sample Loop	0.18 mm (0.007") ID x 1/16" OD	ea.
7021	10 μL Sample Loop	0.30 mm (0.012") ID x 1/16" OD	ea.
7022	20 μL Sample Loop	0.51 mm (0.020") ID x 1/16" OD	ea.
7023	50 μL Sample Loop	0.51 mm (0.020") ID x 1/16" OD	ea.
7024	100 μL Sample Loop	0.51 mm (0.020") ID x 1/16" OD	ea.
7025	200 μL Sample Loop	0.76 mm (0.030") ID x 1/16" OD	ea.
7026	500 μL Sample Loop	0.76 mm (0.030") ID x 1/16" OD	ea.
7027	1.0 mL Sample Loop	0.76 mm (0.030") ID x 1/16" OD	ea.
7028	2.0 mL Sample Loop	1.0 mm (0.040") ID x 1/16" OD	ea.
7029	5.0 mL Sample Loop	1.0 mm (0.040") ID x 1/16" OD	ea.
1876	10 mL Sample Loop	2.0 mm (0.080") ID x 1/8" OD	ea.
STAINLESS STEEL LOOPS FOR 3725-038, 3725I-038 INJECTION VALVES			
3065-018	2.0 mL Sample Loop	2.0 mm (0.080") ID x 1/8" OD	ea.
3065-019	5.0 mL Sample Loop	2.0 mm (0.080") ID x 1/8" OD	ea.
3065-023	10 mL Sample Loop	2.0 mm (0.080") ID x 1/8" OD	ea.
3065-025	20 mL Sample Loop	2.0 mm (0.080") ID x 1/8" OD	ea.
STAINLESS STEEL LOOPS FOR 7725, 7725I, PR/EV700-100, PR/EV703-100, MX MODULE INJECTION VALVES (DO NOT USE FOR 7125)			
7755-020	5 μL Sample Loop	0.18 mm (0.007") ID x 1/16" OD	ea.
7755-021	10 μL Sample Loop	0.30 mm (0.012") ID x 1/16" OD	ea.
7755-022	20 μL Sample Loop	0.30 mm (0.012") ID x 1/16" OD	ea.
7755-023	50 μL Sample Loop	0.51 mm (0.020") ID x 1/16" OD	ea.
7755-024	100 μL Sample Loop	0.51 mm (0.020") ID x 1/16" OD	ea.
7755-025	200 μL Sample Loop	0.76 mm (0.030") ID x 1/16" OD	ea.
7755-026	500 μL Sample Loop	0.76 mm (0.030") ID x 1/16" OD	ea.
7755-027	1.0 mL Sample Loop	0.76 mm (0.030") ID x 1/16" OD	ea.
7755-028	2.0 mL Sample Loop	1.0 mm (0.040") ID x 1/16" OD	ea.
7755-029	5.0 mL Sample Loop	1.0 mm (0.040") ID x 1/16" OD	ea.
1876	10 mL Sample Loop	2.0 mm (0.080") ID x 1/8" OD	ea.
STAINLESS STEEL LOOPS FOR 8125 INJECTOR (USE 7755-024 TO 7755-029 FOR VOLUMES > 50 μL)			
8020	5 μL Sample Loop	0.20 mm (0.008") ID x 0.020" OD	ea.
8021	10 μL Sample Loop	0.20 mm (0.008") ID x 0.020" OD	ea.
8022	20 μL Sample Loop	0.25 mm (0.010") ID x 0.020" OD	ea.
8023	50 μL Sample Loop	0.30 mm (0.012") ID x 0.020" OD	ea.



PEEK Sample Loops

Flexible PEEK sample loops are alternatives to stainless steel loops. PEEK loop ends are provided with clean, straight cuts for easy valve installation.

PEEK polymer is inert to almost all organic solvents and is biocompatible, giving PEEK loops added versatility. Natural PEEK is used for these sample loops. Like metal loops, the size designations of PEEK loops are nominal. The actual volumes can differ from the theoretical designations because of the tolerance of the tubing bore. Accuracy of large PEEK loops (0.8 mm, 0.030" bore) is about $\pm 14\%$, intermediate loops (0.5 mm, 0.020") $\pm 21\%$, and small loops (0.2 mm, 0.007") $\pm 65\%$.

PEEK loops are also supplied with unswaged RheFlex® fittings but do not require the same swaging precaution. The fittings can reposition along the loop tubing when the fitting is reinserted in the ports for correct loop installation.



APPLICATION NOTE

Fluidic Movement in Tubes

Q: "Why can I load only up to half of the volume of the loop in partial-filling method?"

A: Sample occupies 2 μL of loop for every 1 μL loaded from the syringe. For example, 10 μL of sample spreads out over the entire length of a 20 μL loop. Any additional sample loaded will overflow the end of the loop and exit out to waste. Reproducibility is poor because the volume of sample in the loop is different from the known volume originally loaded by your syringe.

Fluid spreads in a parabolic shape through a tube instead of moving in one plug because the velocity is different at the center of the tube than at the walls. The velocity at the center of the tube is twice the average velocity, and near the wall the velocity is almost zero, creating a parabolic shape. This fluidic movement is called laminar flow. See Figure 1.

In dual mode injection valves (see "Sample Loop Loading" Application Note on page 131) the sample from the syringe needle loads directly into the sample loop. The sample volume is known since there is no sample waste. The laminar flow phenomenon accounts for the shape of the plot as shown in Figure 2. Note that the plot has three regions:

- 1 Partial-Filling Region.** When the volume dispensed is less than half the loop volume, the curve is linear. Sample has not reached the end of the loop. Within this region, performance depends on the syringe and operator.
- 2 Nonlinear Region.** When the volume dispensed is between half the loop volume and about two loop volumes, the curve is nonlinear. Sample is lost from the loop, so reproducibility is poor. If you dispense a volume equal to the loop size, you are in this region of poor performance.
- 3 Complete-Filling Region.** When the volume of sample dispensed is several loop volumes, the loop contains only pure sample, undiluted by residual mobile phase. Within this region, reproducibility is highest.

In the single mode injection valves the sample must pass through a connecting passage before it reaches the sample loop. Since some of the sample dispensed from the syringe remains in the connecting passageway, an unknown amount enters the sample loop. Therefore, single mode injection valves achieve high reproducibility only by using the complete-filling method.

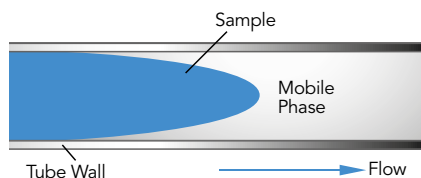

Figure 1 Schematic of sample flow through mobile phase between tubing walls

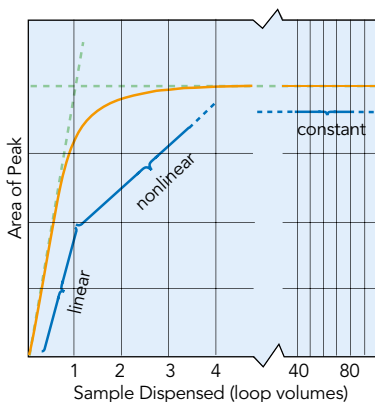

Figure 2 Sample mass (observed peak area) vs. volume of sample dispensed from the syringe, in units of loop volumes, injected onto the column from our dual mode injector such as model 7725



APPLICATION NOTE

PEEK Physical Strength Characteristics

Although PEEK material is compatible with virtually all solvents, there are many factors that affect burst pressure of PEEK tubing. Factors such as increases in inner diameter, temperature, exposure time, and concentration of organic solvents affect the degradation of PEEK. Other solvents such as THF, methylene chloride and DMSO cause PEEK tubing to swell while concentrated nitric acid and sulfuric acid weaken the tubing.



APPLICATION NOTE

How to Find and Fix Common Sample Injector Leaks

Leaks cause valuable sample loss. Nobody wants that. The key to the valve holding pressure is the integrity of the sealing surfaces. If there is a scratch on the sealing surface, or the needle seal in the rotor seal is damaged, a leak may appear. It is also important to realize what appears to be a leak can instead be a result of siphoning. The following are the three most common situations in which fluid leaks occur.

- 1 If fluid leaks out of the needle port only while loading the loop (i.e., while pushing down on the plunger of the syringe), the problem is most likely that the needle seal or the needle port fitting in the loop filler port is not gripping the syringe needle tightly enough. Tighten the needle seal grip by pushing with the eraser end of a pencil on the needle port (See Figure 1). The tightening reduces the hole diameter of the needle seal and port fitting.
- 2 If fluid leaks continuously from the needle port or vent lines and/or from the stator-to-stator ring interface, replace the rotor seal and/or stator face assembly. Scratches on the rotor seal or cracks in the stator face assembly allow mobile phase to escape and cause cross port leakage. Genuine IDEX Health & Science RheBuild® Kits are listed on page 124.
- 3 If fluid leaks from the needle port and/or vent lines but eventually stops, the cause is most likely siphoning and not a leak. Siphoning occurs if the vent lines are lower or higher than the needle port. Adjust the vent line(s) so that the outlet is at the same horizontal level as the needle port to prevent siphoning. (See Figure 2).

For other leakage or injection troubleshooting, refer to our Troubleshooting Guide for HPLC Injection Problems. You may download the Guide from our web site: www.idex-hs.com under Education & Tools.

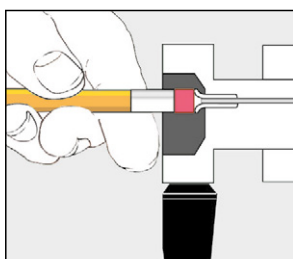

Figure 1 To reform the needle seal, push the eraser end of a pencil against the needle port

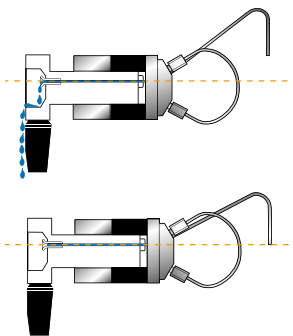

Figure 2 Needle port level compared to the level of vent line outlet:

- (A) siphoning occurs when the vent line outlet is above the needle port level
 (B) siphoning does not occur if the vent line outlet is the same horizontal level as the needle port

PEEK Sample Loops (Cont.)



APPLICATION NOTE

Using Proper Syringe Needles

With front-loading injection valves it is important to use the correct needle when loading the sample loop. An incorrect needle will damage the valve and can cause poor reproducibility. When the needle is too short the tip will not reach the needle seal. When the needle is too small in diameter the seal will not grip tightly enough. Needles with a beveled tip can damage the rotor seal and stator face assembly (see Figure 1). The needle should be #22 gauge (0.028"–0.0285"/ 0.72 mm), and 90° point style (square cut end). Model 3725i requires a #16 gauge (0.0645"–0.0655"/ 1.65 mm) needle. Never use a beveled, pointed, or tapered needle.

Needle specifications are not critical when using a Loop Filler Port to load the sample loop. However, it is important to tighten the needle port fitting around the needle if using a syringe needle with a slightly smaller diameter than 0.7 mm (0.028").

If the loading method used is complete-filling, a syringe without a needle can be used. A syringe fitted with a Needle Port Cleaner can be used with a front-loading valve (Figure 2A) or with a Loop Filler Port (Figure 2B).

Needle port accessories are listed on page 132.

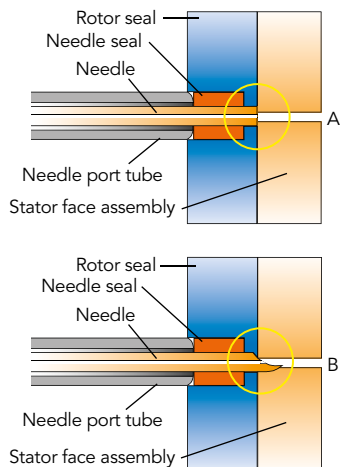

Figure 1 A square cut needle:
(A) stops against the stator face assembly; The tip of a pointed needle
(B) slips into the stator face and the tip breaks off as the valve rotates

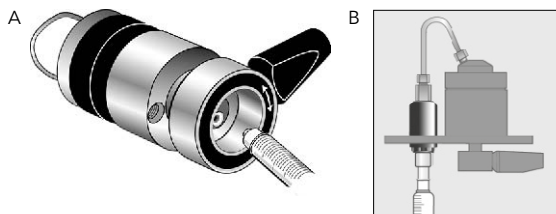
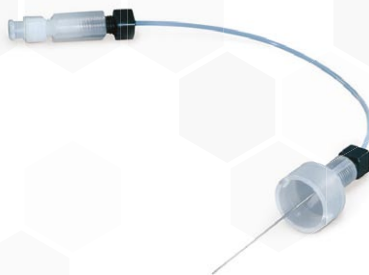

Figure 2
(A) Syringe fitted with Needle Port Cleaner (Part # 7125-054) loading a front-loading valve (model 7725);
(B) loading a Loop Filler Port (Part # 7012)

PEEK Sample Loops

Part No.	Volume	Tubing	Valco No.	Qty.
PEEK LOOPS FOR 3725, 3725I INJECTION VALVES				
3055-018	2.0 mL Sample Loop	1.6 mm (0.062") ID x 1/8" OD	N/A	ea.
3055-019	5.0 mL Sample Loop	1.6 mm (0.062") ID x 1/8" OD	N/A	ea.
3055-023	10 mL Sample Loop	2.0 mm (0.080") ID x 1/8" OD	N/A	ea.
3055-025	20 mL Sample Loop	2.0 mm (0.080") ID x 1/8" OD	N/A	ea.
PEEK LOOPS FOR 9725, 9010, PR/EV750-100, PR/EV753-100 INJECTION VALVES				
Part No.	Volume	Bore / Tubing	Valco No.	
9055-020	5.0 µL Sample Loop	0.18 mm (0.007") ID x 1/16" OD	SL5CWPK	ea.
9055-021	10 µL Sample Loop	0.25 mm (0.010") ID x 1/16" OD	SL10WPK	ea.
9055-022	20 µL Sample Loop	0.25 mm (0.010") ID x 1/16" OD	SL20WPK	ea.
9055-023	50 µL Sample Loop	0.51 mm (0.020") ID x 1/16" OD	SL50WPK	ea.
9055-024	100 µL Sample Loop	0.51 mm (0.020") ID x 1/16" OD	SL100WPK	ea.
9055-025	200 µL Sample Loop	0.51 mm (0.020") ID x 1/16" OD	N/A	ea.
9055-026	500 µL Sample Loop	0.76 mm (0.030") ID x 1/16" OD	SL500WPK	ea.
9055-027	1.0 mL Sample Loop	0.76 mm (0.030") ID x 1/16" OD	SL1KCWPK	ea.
9055-028	2.0 mL Sample Loop	0.76 mm (0.030") ID x 1/16" OD	SL2KCWPK	ea.
9055-029	5.0 mL Sample Loop	0.76 mm (0.030") ID x 1/16" OD	N/A	ea.
9055-033	10 mL Sample Loop	0.76 mm (0.030") ID x 1/16" OD	N/A	ea.
PEEK LOOPS FOR 7725, 7725I, PR/EV700-100				
7123-227	1 µL Sample Loop (models PR/EV700-100 and EV750-100 only)	Internal groove	N/A	ea.
7755-015	2 µL Sample Loop (models 7725, 7725i, and 9725(i) only)	Internal groove	N/A	ea.
REPLACEMENT RHEFLX FITTINGS FOR PEEK LOOPS				
6000-078	Nut/Ferrule Set, Natural PEEK, 5/16-24, for 1/8" OD loops			ea.
6000-079	Ferrules, Natural PEEK, for 1/8" OD loops			5-pk
6000-251	Ferrules, Natural PEEK, for 1/16" OD loops			10-pk
6000-254	Nut/Ferrule Sets, Natural PEEK, 10-32, for 1/16" OD loops			10-pk

Suction Needle Adapter



Our adaptable Loop Filler Ports (Part #7012 and 9012) are used to load sample from syringe needles or luer tips. The Needle Port (Part #9013) conserves sample by minimizing the volume between the needle and the valve.

9125-076

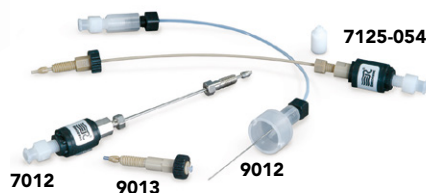

APPLICATION NOTE

Flow path for the typical dual mode injector

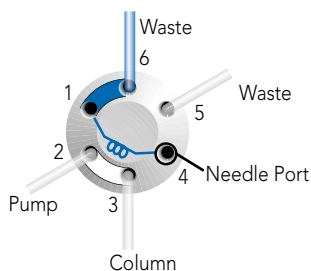

LOAD

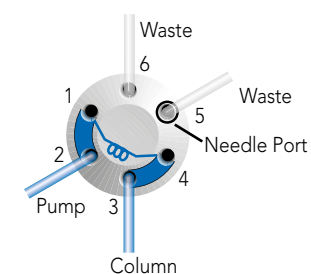

INJECT

Dual Mode Sample Loop Loading: Partial-Filling vs. Complete-Filling

Partial-Filling

Use the partial-filling method if you need to conserve sample, or if you want to vary sample volume frequently.

In partial-filling, the syringe sets the volume injected onto the column. There is no sample waste, and the volume injected onto the column is equal to that dispensed from the syringe. Reproducibility is 1.0% relative standard deviation (RSD). The volume of the sample loaded is limited to half the sample loop volume. For example, the most you can load into a 200 μL sample loop is 100 μL .

Complete-Filling

Use the complete-filling method if you have plenty of sample, if you do not vary sample volume, or if you need high reproducibility.

In complete-filling, the loop sets the volume loaded onto the column. Use excess sample (two to five loop volumes) to replace all the mobile phase in the loop. See Figure 2. Change the loop to vary the sample volume. Reproducibility is typically 0.1% RSD for loop sizes $\geq 5 \mu\text{L}$. Accuracy is limited as loop volumes are nominal.

Q: "Which method should I use and which IDEX Health & Science sample injection valves use this method?"

A: There are two types of injection valves available: dual mode and single mode. Dual mode injection valves allow both partial- and complete-filling whereas single mode injection valves allow only complete-filling. See manual injection valves, page 123.

If you are collecting experimental data, sample is scarce, and/or you want to use different sample volumes, a dual mode injector with a large volume sample loop is appropriate. Only dual mode injection valves allow the partial-filling method for easily varying your volumes (up to half your sample loop volume) by setting the syringe volume. Once you begin routine analysis, and/or you have an abundance of sample, either a dual mode or single mode injector is appropriate. Both types of injection valves allow the complete-filling method in which you overflow the sample loop. Complete-filling maximizes the reproducibility of your results.

Part No.	Description	Qty.
SUCTION NEEDLE ADAPTER & ACCESSORIES		
7012	Stainless Steel Loop Filler Port	ea.
7125-054	Needle Port Cleaner	ea.
9012	PEEK Loop Filler Port	ea.
9013	PEEK Needle Port	ea.
9125-076	Suction Needle Adapter (for Models 7725 and 9725)	ea.



V-447

Injection Port Adapters

- › For 360 µm OD tubing
- › Mount on bracket or bulkhead

To introduce sample, connect 360 µm OD capillary tubing to an Injection Port Adapter Assembly. This adapter accepts standard 22 gauge Hamilton-style injection syringe needles. No additional swept volume is added to the fluid pathway by this adapter, as the needle butts directly against the connecting tubing during injections. The adapter can be bulkhead mounted or mounted with the V-447 Kits.

To introduce a sample directly into a 10-32 port, purchase a M-432-03 separately.

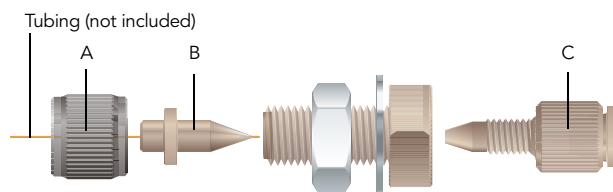

M-432
Micro Injection Port Adapter Assembly

RELATED PRODUCTS

	A	B	C
FOR 360 µm OD TUBING			
M-432 and V-447	P-416BLK	F-152	M-432-03

- › For use with Injection Valves on page 123.

This simple, biocompatible adapter is designed specifically for the Injection Valves on page 123 and can also convert any 1/4-28 flat-bottom port into a port that can accept a standard 22 gauge HPLC injection needle. This injection port adapter is adjustable, so you can create a snug fit around the needle to prevent any leaking of the analyte. In addition, this product features an internal stop that prevents you from inserting the needle too far, eliminating the possibility of damaging the valve with the needle tip.

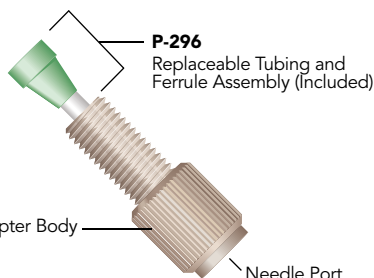

P-295
1/4-28 Flat-Bottom
Injection Port Adapter

P-296
Replaceable Tubing and
Ferrule Assembly (Included)

Adapter Body

Needle Port

Part No.	Description	Qty.
MICRO INJECTION PORT ADAPTER		
FOR 360 µm OD TUBING		
F-152	Replacement MicroFerrule for M-432, Natural PEEK	ea.
M-432	Micro Injection Port Adapter Assembly	ea.
M-432-03	Replacement Tubing/Fitting Assembly for M-432 & M-433	ea.
P-416BLK	Replacement Female Nut for M-432, Black PEEK	ea.
V-447	Micro Injection Port Adapter Assembly Actuator Mounting Kit Includes (1) M-432 with mini-actuator bracket and (2) mounting screws	ea.
1/4-28 FLAT-BOTTOM INJECTION PORT ADAPTER		
P-295	Adjustable Injection Port Adapter	ea.
P-296	Replacement Tubing/Ferrule Assembly	ea.

Wrenches, Brackets, & Replacement Fittings



6810

Valve Wrenches

- › For convenient wrench-tightening of fittings on high pressure rotary shear valves
- › For removal of knobs on Manual Valves

The smartly designed IDEX Wrench is a double-ended slotted socket wrench that fits over 1/16" and 1/8" OD tubing. It easily loosens and tightens 1/4" and 5/16" hex head stainless steel or PEEK fittings. The "Z" shape of the IDEX Wrench provides ideal leverage for changing sample loops and fittings, and keeps one end from restricting the use of the other.

The V-103 is an Allen (hex-key) wrench designed to remove the knob from our V-101 valves (page 123). The V-104 is an Allen wrench that can be used to remove the knob from our Medium Pressure Selection and Injection Valves (also found on page 123).



7160-010

7160

Mounting Brackets

Our mounting brackets and panels of different shapes and sizes organize and provide a sturdy support for IDEX Health & Science valves. The Ring Stand Mounting Bracket now allows the valves to mount onto common laboratory equipment.

7160-029



MXX Replacement Fittings

Use these replacement Ferrules and O-rings for 1/8" and 1/16" tubing with the MXX Series II valves shown on page 119. Please see the part number chart below for a list of individual part numbers.

Part No.	Description	Qty.
VALVE WRENCHES		
6810	IDEX Wrench	ea.
MOUNTING BRACKET ACCESSORIES		
7160	Mounting Panel	ea.
7160-010	Valve Angle Bracket	ea.
7160-029	Ring Stand Mounting Bracket	ea.
VALVE BRACKET		
M-615-1	Mounting Bracket for IDEX Health & Science Switching Valves	ea.
M-615-2	Mounting Bracket for IDEX Health & Science Injection and Selection Valves	ea.
REPLACEMENT FITTINGS		
7770-039	Ferrules for 1/8" OD Tubing	25-pk
7770-040	Ferrules for 1/8" Tubing	50-pk
7770-044	Ferrules for 1/16" OD Tubing	25-pk
7770-124	O-rings for 1/16" OD Tubing	25-pk



FLOW REGULATING VALVES

Our Flow Regulating Valves include specifically designed valves that are used to control or stop the flow of a stream and are ideal for use if your application involves low frequency of use or demands operator control. A variety of types and styles of valves allow you to manage directional flow. In addition, we offer replacement cartridges for all of our flow regulating valves.

- 135** CHECK VALVES
- 140** MICRO-SPLITTER VALVES
- 141** MICRO-METERING VALVES
- 142** SHUT-OFF VALVES



Inline Cartridge Check Valves

- › Low cracking pressures
- › Less than 150 μ L internal volume
- › **Materials of construction:**
PEEK; perfluoroelastomer (CV-3001);
gold-plated stainless steel spring
(CV-3001); ethylene propylene (CV-3011);
and stainless steel spring (CV-3011)

Our cartridge-style Inline Check Valves are designed to limit flow to one direction. These assemblies withstand system pressures of 1,000 psi (69 bar). The cracking pressures for the Inline Check Valve Cartridges are 1.5 psi (0.1 bar) for the CV-3001 and 3 psi (0.2 bar) for the CV-3011. Tolerance on the cracking pressure for CV-3001 is ± 0.5 psi (0.03 bar) and ± 1.5 psi (0.1 bar) on CV-3011.

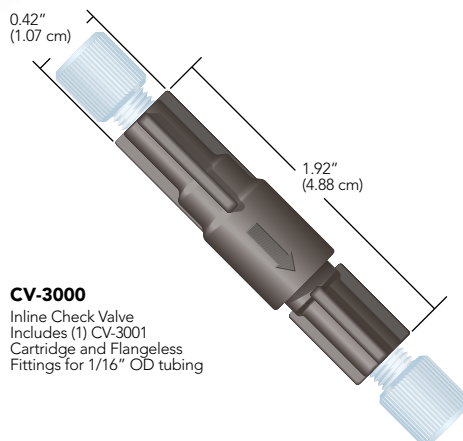

Part No.	Description	Includes	Swept Volume	Qty.
INLINE CARTRIDGE CHECK VALVES				
CV-3000	Inline Check Valve Assembly for 1/16" OD tubing	(1) CV-3001, (2) XP-215	96 μ L	ea.
CV-3001	Inline Check Valve Cartridge for CV-3000		91 μ L	ea.
CV-3010	Inline Check Valve Assembly for 1/8" OD tubing	(1) CV-3011, (2) XP-315	100 μ L	ea.



Standard 1/4-28 Inline Check Valves

- › Add back-flow protection to any 1/4-28 flat-bottom port
- › 15 psi (1 bar) and 3 psi (0.2 bar) cracking pressure versions
- › Excellent chemical resistance
- › **Materials of construction:**
PEEK; PCTFE; perfluoroelastomer;
PTFE (CV-3301 and CV-3302);
stainless steel (CV-3301 and CV-3302);
or gold-plated stainless steel
(CV-3315 and CV-3316)

Connect these Inline Check Valves to any 1/4-28 flat-bottom port. Then thread your 1/4-28 flat-bottom fitting into the check valve to connect the tubing. Once installed, the spring-actuated sealing system eliminates back flow, helping to prevent upstream contamination or damage. In addition, the unique design of this product eliminates the additional tubing cuts and connections required to install conventional inline check valves.

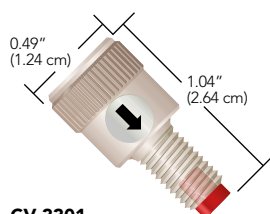

CV-3301
Standard, Inlet
1/4-28 FB Male to 1/4-28 FB Female
15 psi (1 bar) cracking pressure

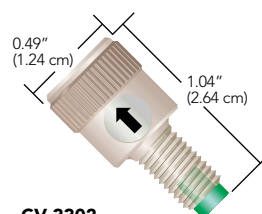

CV-3302
Standard, Outlet
1/4-28 FB Male to 1/4-28 FB Female
15 psi (1 bar) cracking pressure

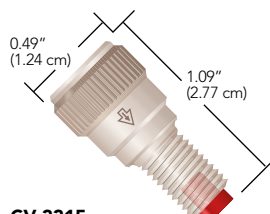

CV-3315
Standard, Inlet
1/4-28 FB Male to 1/4-28 FB Female
3 psi (0.2 bar) cracking pressure

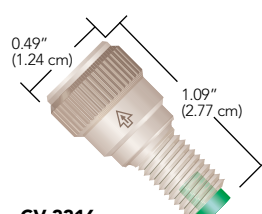

CV-3316
Standard, Outlet
1/4-28 FB Male to 1/4-28 FB Female
3 psi (0.2 bar) cracking pressure



RELATED PRODUCTS

- › 1/4-28 Inline Check Valves and Non-Metallic Check Valves with 1/4-28 flat-bottom ports (next page) can be used with any 1/4-28 Flangeless, Super Flangeless™, and VacuTight™ fitting on pages 45, 39, and 42, respectively, of the Fittings Chapter.
- › Micro-Volume Inline Check Valves and Non-Metallic Check Valves with 10-32 coned ports (next page) can be used with any 10-32 polymer Fingertight or SealTight™ fitting on page 36. Connect capillary tubing using the optional ferrules listed on page 35 or the NanoTight™ Fittings and Tubing Sleeves on page 37.

Part No.	Description	Cracking Pressure	Qty.
STANDARD 1/4-28 INLINE CHECK VALVES			
CV-3301	Inlet Check Valve, 1/4-28 FB, M to 1/4-28 FB, F*	15 psi (1 bar)	ea.
CV-3302	Outlet Check Valve, 1/4-28 FB, M to 1/4-28 FB, F*	15 psi (1 bar)	ea.
CV-3315	Inlet Check Valve, 1/4-28 FB, M to 1/4-28 FB, F*	3 psi (0.2 bar)	ea.
CV-3316	Outlet Check Valve, 1/4-28 FB, M to 1/4-28 FB, F*	3 psi (0.2 bar)	ea.

* M = Male (external) threads; F = Female (internal) threads; C = Coned; FB = Flat-Bottom



Non-Metallic Check Valves

- › Cracking pressure of 8 psi (0.6 bar)
- › Excellent chemical resistance
- › **Materials of construction:**
PEEK and perfluoroelastomer,
suitable for biological applications

Our Non-Metallic Check Valves are biocompatible and delivers a low cracking pressure. With a swept volume of only 7.4 μL , our Check Valve is perfect for applications where low flow path volume is critical, such as delivery to lab-on-a-chip, single-cell analysis and micro- or nano-LC post-column derivatization. Once installed, this check valve helps prevent back flow and the potential for contamination or damage to sensitive upstream equipment.

10-32 Micro-Volume Inline Check Valves

With a swept volume of only 7.4 μL , our 10-32 Micro-Volume Inline Check Valves are perfect for applications where low flow path volume is critical, such as delivery to lab-on-a-chip, single-cell analysis and micro- or nano-LC post-column derivatization. Once installed, this check valve helps prevent back flow and the potential for contamination or damage to sensitive upstream equipment.

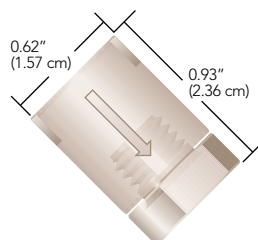

CV-3500
Micro-Volume Inline
10-32 C Female to 10-32 C Female

NOTE

Check valves are specified by:

- › **Cracking Pressure:** the pressure required for the valve to open in the direction of the arrow.
- › **Maximum Pressure:** the maximum pressure the valve can experience in the reverse direction without leaking backwards.
- › **Back Pressure Created:** the amount of back pressure generated by the check valve with 50 mL/min room temperature water flowing in the direction of the arrow.

SPECIFICATIONS & DETAILS

	Swept Volume	Thru-Hole	Max. Pressure Rating	Back Pressure Created	Cracking Pressure Tolerance
STANDARD 1/4-28 FB					
CV-3301, CV-3302	20 μL	0.020" (0.50 mm)	2,000 psi (138 bar)	45 psi (3.1 bar)	± 5 psi (0.34 bar)
CV-3315, CV-3316	16 μL	0.020" (0.50 mm)	2,000 psi (138 bar)	10 psi (0.7 bar)	± 1.5 psi (0.10 bar)
NONMETALLIC 10-32 CONED MICRO-VOLUME					
CV-3500	7.4 μL	0.010" (0.25 mm)	3,000 psi (207 bar)	25 psi (1.7 bar)	± 5 psi (0.34 bar)

10-32 Micro-Volume Inline Check Valves

Part No.	Description	Cracking Pressure	Qty.
NONMETALLIC 10-32 MICRO-VOLUME INLINE CHECK VALVE			
CV-3500	Inlet/Outlet Check Valve, 10-32 C, F to 10-32 C, F*	8 psi (0.6 bar)	ea.

* M = Male (external) threads; F = Female (internal) threads; C = Coned; FB = Flat-Bottom

Non-Metallic Check Valves (Cont.)

- › Low cracking pressure of 1 psi (0.07 bar)
- › Multiple configurations for different applications
- › Excellent chemical resistance
- › **Materials of construction:**
PEEK and perfluoroelastomer

1/4-28 & 10-32 Inline Check Valves

Our 1/4-28 & 10-32 Non-Metallic Inline Check Valves provide excellent backflow protection for sensitive equipment along with outstanding chemical resistance guaranteed by the PEEK polymer and perfluoroelastomer construction. Metal-free composition makes these check valves perfect for use with corrosive fluids or biological samples.

These check valves function well up to moderately-high pressure applications. Low internal volume also allows them to be used in areas where flow path volume is important; however, higher flow rates can pass through with minimal pressure drop.

APPLICATION NOTE

- › The CV-3320 or CV-3321 style can be connected to any 1/4-28 flat-bottom port for trouble-free back flow protection.
- › When using a pump after the analytical column, consider placing a CV-3330 Check Valve after the column to prevent fluid from the post-column pump from flowing backwards through the column. This product also serves as an excellent nonmetallic alternative to our CV-3010 (page 135) in sparging applications where the mobile phase may be corrosive to the stainless steel or ethylene propylene components inside the CV-3010 assembly.
- › The CV-3335 Inlet and CV-3336 Outlet Check Valves allow tubing larger than 1/16" OD (up to 1/8") to be connected into a 10-32 coned internal port. Use both of these check valves when attaching a larger-volume sample loop to an analytical-scale injection valve. This setup limits the flow of the sample into the loop to one direction, minimizing back flow and sample carry-over.
- › The CV-3340 is useful in virtually any high pressure fluid pathway using 1/16" or smaller OD tubing, where limiting the direction of flow is desirable.

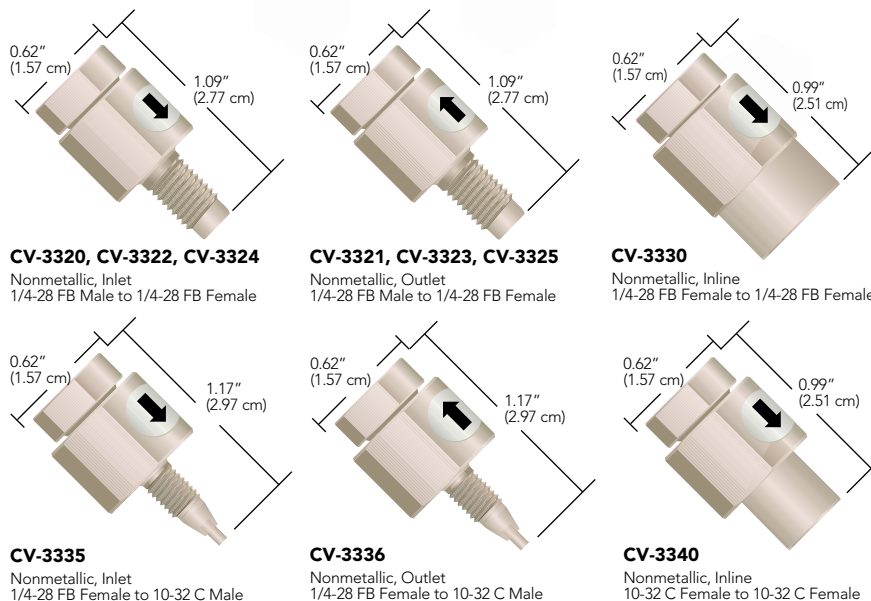

SPECIFICATIONS & DETAILS

	Swept Volume	Max. Pressure Rating	Back Pressure Created	Cracking Pressure Tolerance
CV-3320, CV-3321	37 µL	2,000 psi (138 bar)	30 psi (2.1 bar)	± 0.5 psi (0.03 bar)
CV-3330	34 µL	2,000 psi (138 bar)	30 psi (2.1 bar)	± 0.5 psi (0.03 bar)
CV-3335, CV-3336	49 µL	2,000 psi (138 bar)	30 psi (2.1 bar)	± 0.5 psi (0.03 bar)
CV-3340	34 µL	2,000 psi (138 bar)	30 psi (2.1 bar)	± 0.5 psi (0.03 bar)
CV-3322, CV-3323	49 µL	2,000 psi (138 bar)	30 psi (2.1 bar)	± 0.5 psi (0.03 bar)
CV-3324, CV-3325	182 µL	2,000 psi (138 bar)	30 psi (2.1 bar)	± 0.5 psi (0.03 bar)

NOTE

Upon initial use — or following a period of extended inactivity — the cracking pressure for these check valves may be somewhat higher than the stated cracking pressure.

1/4-28 & 10-32 Inline Check Valves

Part No.	Description	Cracking Pressure	Thru-Hole	Qty.
NONMETALLIC 1/4-28 AND 10-32 INLINE CHECK VALVES				
CV-3320	Inlet Check Valve, 1/4-28 FB, M to 1/4-28 FB, F*	1 psi (0.07 bar)	0.020" (0.50 mm)	ea.
CV-3321	Outlet Check Valve, 1/4-28 FB, M to 1/4-28 FB, F*	1 psi (0.07 bar)	0.020" (0.50 mm)	ea.
CV-3322	Inlet Check Valve, 1/4-28 FB, M to 1/4-28 FB, F*	1 psi (0.07 bar)	0.040" (1.0 mm)	ea.
CV-3323	Outlet Check Valve, 1/4-28 FB, M to 1/4-28 FB, F*	1 psi (0.07 bar)	0.040" (1.0 mm)	ea.
CV-3324	Inlet Check Valve, 1/4-28 FB, M to 1/4-28 FB, F*	1 psi (0.07 bar)	0.060" (1.60 mm)	ea.
CV-3325	Outlet Check Valve, 1/4-28 FB, M to 1/4-28 FB, F*	1 psi (0.07 bar)	0.060" (1.60 mm)	ea.
CV-3330	Inlet/Outlet Check Valve, 1/4-28 FB, F to 1/4-28 FB, F*	1 psi (0.07 bar)	0.020" (0.50 mm)	ea.
CV-3335	Inlet Check Valve, 1/4-28 FB, F to 10-32 C, M*	1 psi (0.07 bar)	0.020" (0.50 mm)	ea.
CV-3336	Outlet Check Valve, 1/4-28 FB, F to 10-32 C, M*	1 psi (0.07 bar)	0.020" (0.50 mm)	ea.
CV-3340	Inlet/Outlet Check Valve, 10-32 C, F to 10-32 C, F*	1 psi (0.07 bar)	0.020" (0.50 mm)	ea.

* M = Male (external) threads; F = Female (internal) threads; C = Coned; FB = Flat-Bottom



Quick-Stop Luer Inline Check Valve

- › Check valve protection with luer convenience
- › Remains open when engaged
- › **Materials of construction:** PEEK, perfluoroelastomer, and gold-plated stainless steel spring

The Quick-Stop Luer Check Valve is designed to provide inline luer connect/disconnect convenience without the mess and hazard of spills. Just connect the valve assembly to your inline tubing using standard 1/4-28 flat-bottom fittings (see pages 39 – 46). The check valve is automatically opened once the luer connection is engaged, allowing flow in either direction. Disconnecting the luer union causes the check valve to close. Please see the “Application Note” on this page for specific ideas regarding use of this valve.



RELATED PRODUCTS

- › 1/4-28 Inline Check Valves and Non-Metallic Check Valves with 1/4-28 flat-bottom ports (next page) can be used with any 1/4-28 Flangeless, Super Flangeless™, and VacuTight™ fitting on pages 45, 39, and 42, respectively, of the Fittings Chapter.
- › Micro-Volume Inline Check Valves and Non-Metallic Check Valves with 10-32 coned ports (page 137) can be used with any 10-32 polymer Fingertight or SealTight™ fitting on page 36. Connect capillary tubing using the optional ferrules listed on page 35 or the NanoTight™ Fittings and Tubing Sleeves on page 37.



APPLICATION NOTE

Inlet Solvent Reservoir:

Quickly change your solvent on the low pressure end of an HPLC system, while preventing potentially hazardous spills! Just install a Quick-Stop Luer Check Valve Assembly between your solvent reservoir and the pump, with the valve towards the bottle. The valve will prevent solvent leakage from the line coming from the reservoir, while the check valves in your pump prevent spills from the line leading to the pump. With both lines still full of solvent, this system also helps reduce the need to reprime your pump.

FIA Sample Injection:

The Quick-Stop Luer Check Valve provides a practical means to introduce a sample into FIA and other low pressure systems, when used in conjunction with a P-612 Pressure Relief Valve Tee (page 148). Simply connect the Tee into the appropriate flow path line with the included fittings and thread the P-697 Quick-Stop Luer Valve onto the 1/4-28 male end of the Tee. Sample can then be introduced conveniently by using a standard luer-tipped syringe. The check valve is automatically opened when the syringe is attached and closed when the syringe is removed.

Post Column Derivatization:

For post-column derivatization, place a CV-3000 Inline Check Valve on the effluent side of your column to prevent derivatizing agents from flowing backwards and poisoning the column. Placement on the post-column reagent line will also prevent mobile phase from contaminating the reagent if the auxiliary pump fails.

Helium Sparging Tank Protection:

Try the CV-3010 Assembly, designed specifically for degassing (sparging) lines to prevent solvent backup if the sparging gas runs out. This check valve will help prevent potential solvent cross-contamination and damage to the gas regulating valve.

Part No.	Description	Includes	Swept Volume	Qty.
QUICK-STOP LUER CHECK VALVE				
P-696	Quick-Stop Luer Check Valve Assembly	(1) P-697, (1) P-655	127 µL	ea.
P-697	Quick-Stop Luer Check Valve		107 µL	ea.
P-699	Bulkhead Quick-Stop Luer Valve	(1) nut/lock washer set	107 µL	ea.



Micro-Splitter Valves

- › For interfacing LC-MS systems
- › Adjustable split stream flow rates
- › Versions for up to 800 psi (55 bar) and up to 4,000 psi (276 bar)



APPLICATION NOTE

- › With an incoming flow rate of 1 mL/min using room temperature water and equal pressures on both outlet lines, the minimum split flow rate is 2 μ L/min for the standard micro-splitter valves and 4.8 μ L/min for the high pressure micro-splitter valves.
- › All Micro-Splitter Valves have been tested at flow rates to 100 mL/min, with a maximum resulting pressure drop of only 45 psi (3.1 bar) when the valve is fully opened.

Our Micro-Splitter Valves are designed to accurately split and control a low-flow stream off a single incoming supply.

Choose between 1/4-28 flat-bottom and 10-32 coned threaded versions.

The High Pressure Micro-Splitter Valves are designed to operate successfully up to 4,000 psi (276 bar) and the standard Micro-Splitter valves are pressure rated to 800 psi (55 bar).

The Graduated Valve offers many of the benefits and features of Micro-Splitter Valves, plus the ability to adjust and set the split flow to repeatable settings. This allows documentation of settings and the resulting flow rates for easier method development. The graduations also make it easier to employ the valve in a system used to run multiple analyses that require different split flow rates.

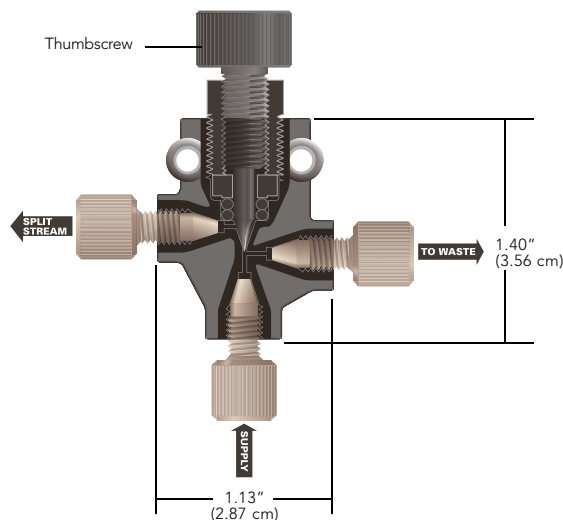

P-451
Standard Micro-Splitter Valve



SPECIFICATIONS & DETAILS

Part No.	Valve Type	Threads	Internal Volume ¹ (closed/fully open)	Max. Operating Pressure
P-450	Standard	1/4-28	2.1 / 4.1 μ L	800 psi (55 bar)
P-451	Standard	10-32	1.2 / 2.8 μ L	800 psi (55 bar)
P-460S, T	High Pressure	10-32	1.2 / 2.8 μ L	4,000 psi (276 bar)
P-470	High Pres. Graduated	10-32	1.2 / 2.8 μ L	4,000 psi (276 bar)

¹ The supply and waste port thru-holes have IDs of 0.020" (0.50 mm). The ID for the split-stream port thru-hole is 0.020" (0.50 mm) in standard versions; in capillary versions it is 0.010" (0.25 mm).

Part No.	Description	Includes	Qty.
MICRO-SPLITTER VALVES			
P-450	Standard, 1/4-28, Biocompatible	(3) XP-235	ea.
P-451	Standard, 10-32, Biocompatible	(3) F-120	ea.
P-460S	High Pressure, 10-32, with Stainless Steel Needle	(3) F-120	ea.
P-460T	High Pressure, 10-32, with Titanium Needle	(3) F-120	ea.
GRADUATED MICRO-SPLITTER VALVES			
P-470	High Pressure Graduated, 10-32, with Stainless Steel Needle	(3) F-120	ea.

* Use with the MicroTight Tubing Sleeves, found on page 52.



Micro-Metering Valves

- › Flow rates as low as 3.5 $\mu\text{L}/\text{min}^*$
- › 1/4-28 flat-bottom and 10-32 coned designs available
- › **Materials of construction:** PEEK, PTFE

* At 1.0 mL/min incoming flow rate with room temperature water.

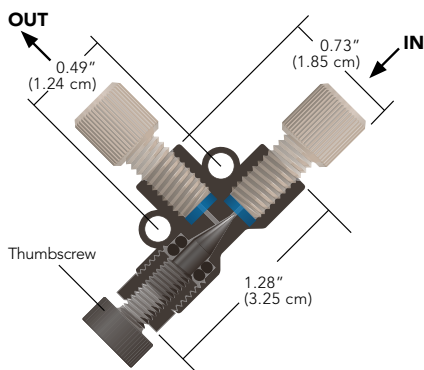

P-445
1/4-28 threaded
PEEK Micro-Metering Valve

For fine control of fluid flow rates, Micro-Metering Valves can reduce outgoing flow to as low as 3.5 $\mu\text{L}/\text{min}^*$. These needle valves are perfect for use with peristaltic pump fluid-transfer applications, mass spectrometry, and fraction collection.

Our Micro-Metering Valves can also be used to regulate gas flow in helium sparging lines and as a flow-dependent variable back pressure regulator. For flow independent regulation of back pressure, please see page 147.

Flow path materials are PEEK polymer and PTFE. All versions of this valve have 0.020" (0.50 mm) thru-holes.



APPLICATION NOTE

Back Pressure Considerations

The Micro-Splitter Valves are designed to work when both effluent flow path pressures are nearly identical. However, the split flow path will often have higher back pressure than the waste flow path, making it hard to achieve any split flow at all. There are two possible solutions. Place a back pressure regulator (page 143) on the waste flow path that is equal to or slightly greater than the pressure on the split flow path.

Or, switch the two effluent pathways such that the split flow pathway is attached to the "waste" port on the valve and the waste flow pathway is attached to the "split" port on the valve. (*Please Note: This second method may result in a loss of adjustment sensitivity.*)

Multi-Column and Detector Systems

Does your work require analyses with multiple columns and detectors that use the same mobile phase? If so, install one of our High Pressure Micro-Splitter Valves after your injector. A single injection can then be split to two separate columns and detector systems, at two different flow rates. This economical set-up eliminates the need for an additional pump and injector valve, while allowing data to be obtained simultaneously.

Post-Detector Interfacing

Use a Standard Micro-Splitter Valve to route fluid exiting an initial detector to other devices, such as a mass spectrometer and a fraction collector. The valve will split and reduce the flow rate to that required for MS interfacing, while diverting the remainder of the flow to the collector (a back pressure regulator may also be required for this set up, available on page 143).

Other Applications

These valves are also suited for other applications, such as adapting a standard HPLC system to handle microbore analyses. For more information and plumbing diagrams for this application and those listed above, please contact your local distributor or IDEX Health & Science directly.

Part No.	Material	OD Tubing	Thru-hole	Internal Volume*	Includes	Qty.
MICRO-METERING VALVES						
P-445	PEEK, Black	1/16"	0.020" (0.50 mm)	7.7 μL	(2) XP-230	ea.
P-446	PEEK, Black	1/16"	0.020" (0.50 mm)	7.2 μL	(2) F-120	ea.
P-447	PEEK, Black	1/8"	0.020" (0.50 mm)	7.7 μL	(2) XP-330	ea.

* Maximum internal volume, with valve fully open.



Shut-Off Valves

- › Biocompatible, all-polymer flow path
- › Available for 1/16" and 1/8" OD tubing
- › Pressure rated to 500 psi (34 bar)

Stop a flow stream quickly with IDEX Health & Science biocompatible Shut-Off Valves. The bodies are manufactured from either PEEK or ETFE, and both versions feature a PCTFE rotor, making them highly resistant to chemical attack. The blue colorant used in some valve configurations has proven not to leach out with common HPLC solvents.

Connect semi-rigid or rigid tubing, such as PEEK, stainless steel or fluoropolymer, with the 1/4-28 Flangeless Fittings provided. Soft tubing, such as PharMed® or Tygon® (see page 14), may be connected to these valves using our 1/4-28 barbed adapters, found on page 90.

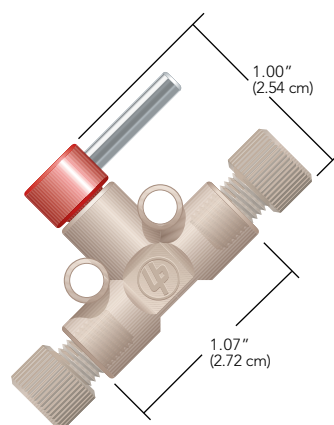

Bio P-733
PEEK Shut-Off Valve

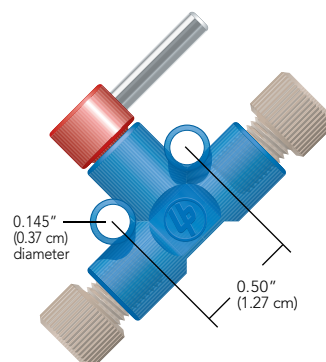

Bio P-783
ETFE Shut-Off Valve

Part No.	Material	OD Tubing	Thru-hole	Internal Volume*	Includes	Qty.
SHUT-OFF VALVES, BIOCOMPATIBLE						
P-721	ETFE, Natural	1/8"	0.040" (1.0 mm)	10.0 µL	(2) P-335, (2) P-300N	ea.
P-732	PEEK, Natural	1/16"	0.020" (0.5 mm)	2.5 µL	(2) XP-235	ea.
P-733	PEEK, Natural	1/8"	0.040" (1.0 mm)	10.0 µL	(2) XP-335	ea.
P-782	ETFE, Blue	1/16"	0.020" (0.5 mm)	2.5 µL	(2) XP-235	ea.
P-783	ETFE, Blue	1/8"	0.040" (1.0 mm)	10.0 µL	(2) XP-335	ea.

* Maximum internal volume, with valve fully open.



BACK PRESSURE REGULATORS

Back Pressure Regulators (BPR) are designed to enhance system performance through outgassing prevention and improved pump check valve efficiency. It includes 5 and 20psi assemblies (replacement cartridges not available), a variety of pressure rated cartridges and assemblies, PEEK and stainless steel BPR holders, high pressure adjustable BPR for pressure between 2000 and 5000psi and ultra-low volume BPRs set to 100 and 500psi.

- 144** ULTRA-LOW VOLUME BACK PRESSURE REGULATOR
- 145** BACK PRESSURE REGULATOR ASSEMBLIES
- 146** BACK PRESSURE REGULATOR HOLDERS
- 147** BACK PRESSURE REGULATOR CARTRIDGES
- 148** PRESSURE RELIEF VALVES



Ultra-Low Volume Back Pressure Regulators (BPRs)

- Wetted flow path materials: PEEK, perfluoroelastomer, and ETFE
- Available pressure settings of 100 or 500 psi (7 or 34 bar)
- Low swept volume of only 6 μL

Our Ultra-Low Volume Back Pressure Regulators (BPRs) were developed to minimize swept volume, which is especially important for multi-detector applications. With a maximum swept volume of only 6 μL *, it is nearly impossible to detect these BPRs as part of your fluid pathway. To minimize the swept volume added to your flow path, we recommend trimming the length of the attached tubing. And because the flow path is completely polymeric, you are assured of biocompatibility.

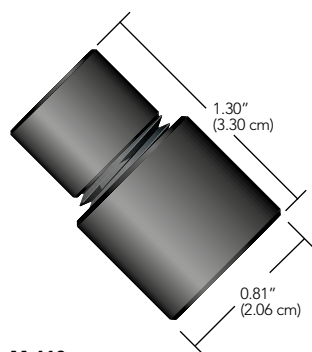

M-410
MicroVolume BPR Assembly
Attached tubing not shown

Please Note: Our Ultra-Low Volume Back Pressure Regulators cannot be used as check valves due to their unique internal design. Try our Micro-Volume Inline Check Valve on page 137.

** The maximum internal swept volume listed above is for the back pressure regulator only and does not include the volume of the attached tubing lines.*



SPECIFICATIONS & DETAILS

	Back Pressure Setting psi (bar)	Flow Rate Recommendations	Recommended Pressure Range psi (bar)	1/16" OD Tubing
M-410	100 ² (7) ²	Optimal: 100 μL –1 mL/min Max.: 4 mL/min	40–150 (3–10)	PEEK, 0.010" ID
M-412	500 ² (34) ²	Optimal: 100 μL –1 mL/min Max.: 4 mL/min	250–525 (17–36)	PEEK, 0.010" ID
M-420	100 ³ (7) ³	Optimal: 3–8 mL/min Max.: 10 mL/min	40–150 (3–10)	PEEK, 0.020" ID

¹ All data generated using water at room temperature.

² Set at a flow rate of 0.5 mL/min.

³ Set at a flow rate of 5 mL/min.

Part No.	Description	Pressure Setting	Tubing OD	Includes	Swept Volume	Qty.
ULTRA-LOW VOLUME BPRs						
M-410	Low Flow	100 psi (7 bar)	1/16"	XP-230	6 μL	ea.
M-412	Low Flow	500 psi (34 bar)	1/16"	XP-230	6 μL	ea.
M-420	High Flow	100 psi (7 bar)	1/16"	XP-230	6 μL	ea.



Back Pressure Regulator Assemblies

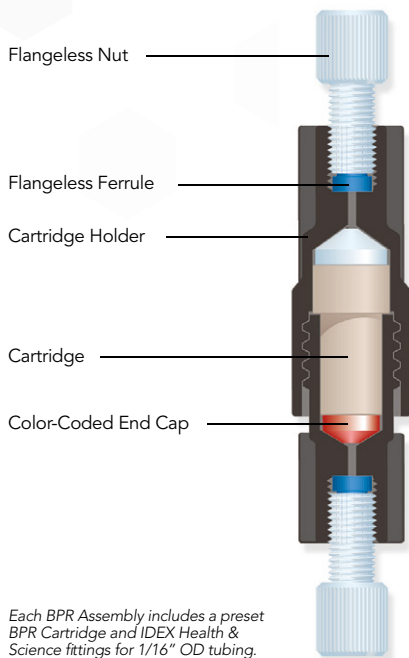

Each BPR Assembly includes a preset BPR Cartridge and IDEX Health & Science fittings for 1/16" OD tubing.

Choose from our line of Biocompatible and Stainless Steel BPR Assemblies, each complete with a replaceable, factory preset cartridge (except the 5 and 20 psi versions).

Our BPR Assemblies create incremental back pressures ranging from 5 to 1,000 psi (0.3 to 69 bar). The Biocompatible BPR Assemblies feature a PEEK holder; polymer-based fittings; biocompatible BPR cartridges and wrenches for tightening. Stainless Steel BPR Assemblies feature the same biocompatible BPR cartridges with a 316 stainless steel holder and polymer fittings.

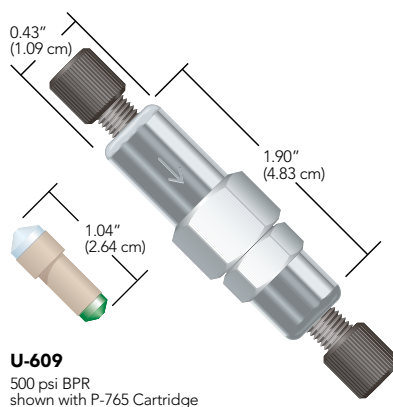

U-609
500 psi BPR
shown with P-765 Cartridge

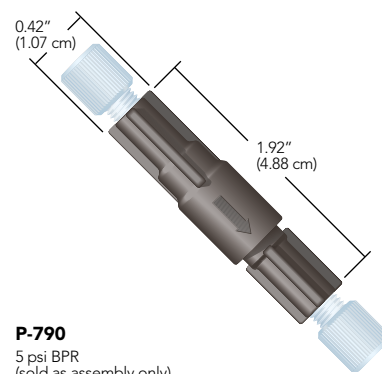

P-790
5 psi BPR
(sold as assembly only)

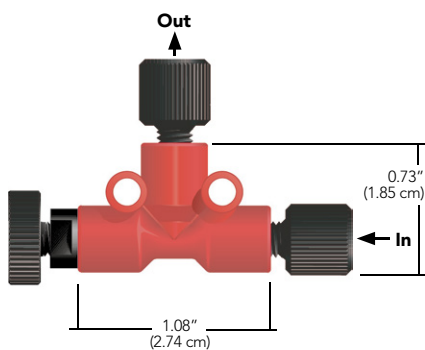

P-880
High Pressure Adjustable BPR
Includes One-Piece Fingertight Fittings for 1/16" OD tubing

High Pressure Adjustable Back Pressure Regulator

› Materials of construction: PEEK, perfluoroelastomer, and PTFE

The biocompatible P-880 High Pressure Adjustable BPR offers the flexibility to adjust your system back pressure between 2,000 and 5,000 psi (138 and 345 bar), independent of the flow. Only 10% fluctuation in pressure generally occurs with flow rates of 0.1–10 mL/min. Lower or higher flow rates will lead to greater fluctuations in pressure. To achieve the desired back pressure setting, simply turn the thumbscrew while monitoring your system pressure. Because this product creates such high back pressure, please check system component specifications prior to using to avoid damaging any sensitive components.

Part No.	Pressure Setting	Holder Material	Includes	Swept Volume	Qty.
BPR ASSEMBLIES					
P-790	5 psi (0.3 bar)	PEEK	(2) XP-215	134 µL	ea.
P-791	20 psi (1.4 bar)	PEEK	(2) XP-215	134 µL	ea.
P-785	40 psi (2.8 bar)	PEEK	(1) P-761, (2) XP-215	131 µL	ea.
P-786	75 psi (5.2 bar)	PEEK	(1) P-762, (2) XP-215	131 µL	ea.
P-787	100 psi (7 bar)	PEEK	(1) P-763, (2) XP-215	131 µL	ea.
P-788	250 psi (17 bar)	PEEK	(1) P-764, (2) XP-235	102 µL	ea.
P-789	500 psi (34 bar)	PEEK	(1) P-765, (2) P-250, (2) LT-115	96 µL	ea.
P-455	1,000 psi (69 bar)	PEEK	(1) P-796, (2) P-250, (2) LT-115	89 µL	ea.
U-605	40 psi (2.8 bar)	SST	(1) P-761, (2) XP-201	129 µL	ea.
U-606	75 psi (5.2 bar)	SST	(1) P-762, (2) XP-201	129 µL	ea.
U-607	100 psi (7 bar)	SST	(1) P-763, (2) XP-201	129 µL	ea.
U-608	250 psi (17 bar)	SST	(1) P-764, (2) XP-201	99 µL	ea.
U-609	500 psi (34 bar)	SST	(1) P-765, (2) XP-201	93 µL	ea.
U-610	750 psi (52 bar)	SST	(1) P-795, (2) P-250, (2) LT-115	91 µL	ea.
HIGH PRESSURE ADJUSTABLE BPR ASSEMBLY					
P-880	2,000–5,000 psi (138–345 bar)		(2) F-120BLK	9 µL	ea.



Back Pressure Regulator Holders

P-465 PEEK and U-469 Stainless Steel BPR Holders work with any of our replacement BPR Cartridges. Each holder comes with fittings for 1/16" OD tubing (see below). The U-469 Holder is surface-treated to prevent galling, a potential problem with large, threaded metal parts.

Please Note: These Back Pressure Regulator Holders are designed to allow each cartridge to operate at its stated pressure setting when tightened to 20 in.-lbs. of torque. To approximate this level of torque, first finger tighten the Holder, then tighten an additional 1/8–1/4 turn with the supplied wrenches.

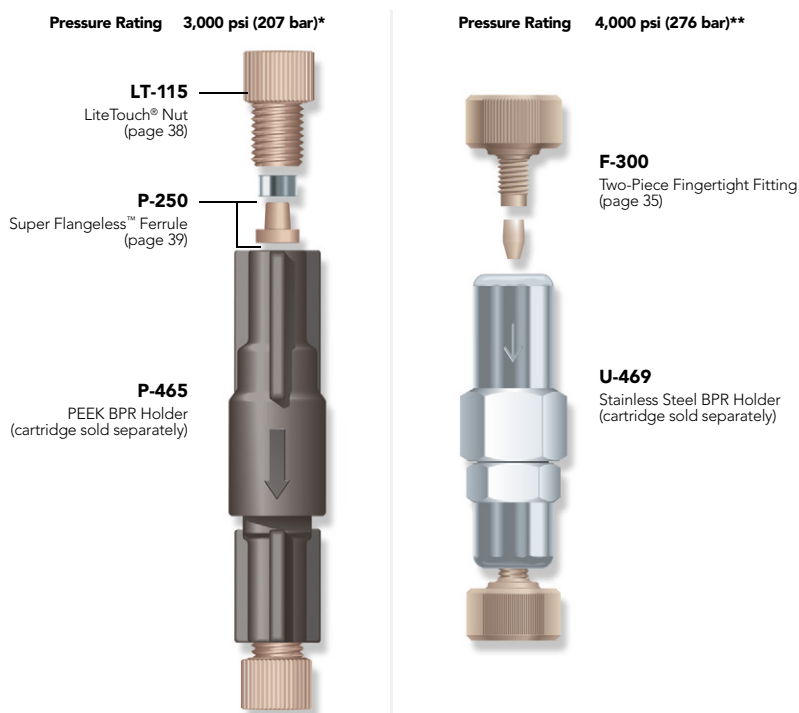

* Using PEEK tubing and supplied fittings.

** Using stainless steel tubing and supplied fittings.

Part No.	Pressure Setting	Holder Material	Includes	Swept Volume	Qty.
BPR HOLDERS					
P-465	Biocompatible BPR	PEEK	(2) P-250, (2) LT-115	7 μ L	ea.
U-469	High Pressure BPR	SST	(2) F-300	4 μ L	ea.



Back Pressure Regulator Cartridges



APPLICATION NOTE

Small gas bubbles often form as solvent moves from the high pressure of an HPLC column to the low pressure environment leading to the detector. This outgassing can cause erratic baseline readings and loss of sensitivity. Placing a BPR (usually a 40–100 psi) after the detector provides an excellent, low-cost method for reducing this problem by maintaining enough back pressure on the mobile phase to keep gases dissolved in solution.

A back pressure regulator can also be used as a pump preload for low and fluctuating pressure applications. Many of today's pumps require a steady back pressure to function properly. Install an IDEX Health & Science BPR (usually 500–1,000 psi) between the pump and the injector to enhance pump performance.

Caution: Do not exceed the maximum operating pressure of your system — please refer to the operating manuals for your system components before choosing the appropriate BPR.

- › Proven outgassing protection
- › Flow-independent pump preload for greater pump efficiency
- › 5 to 1,000 psi cartridges and assemblies available

Back Pressure Regulators are designed to enhance system performance through outgassing prevention and improved pump check valve efficiency.

IDEX Health & Science back pressure regulators include:

- › 5 and 20 psi assemblies (replacement cartridges not available)
- › 40, 75, 100, 250, 500, 750, and 1,000 psi cartridges and assemblies
- › PEEK and stainless steel BPR holders
- › High pressure adjustable BPR for pressures between 2,000 and 5,000 psi
- › Ultra low volume BPRs set to 100 and 500 psi (page 144)

For flow control options try the Micro-Metering Valves found on page 141.

Back Pressure Regulator Replacement Cartridges

- › Materials of construction: PEEK, ETFE, perfluoroelastomer, and gold-plated stainless steel

These replacement cartridges will operate in any of the standard BPR holders shown on this page. These cartridges create back pressures from 40 to 1,000 psi (2.8 to 69 bar)—all independent of flow except as noted below.

The recommended operating flow rate range for our BPR Cartridges is 0.1 mL–10 mL/min. Within this range, the amount of back pressure created by the BPR Cartridges and Assemblies will not vary more than $\pm 10\%$. Lower or higher flow rates may result in larger pressure fluctuations.

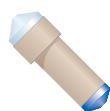

P-761
40 psi BPR Cartridge

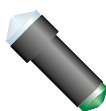

P-796
1,000 psi BPR Cartridge

Part No.	Pressure Setting	COLOR CODING		Swept Volume	Qty.
		Body	End-Cap		
BPR CARTRIDGES					
P-761	40 psi (2.8 bar)	Tan	Blue	125 μ L	ea.
P-762	75 psi (5.2 bar)	Tan	Yellow	125 μ L	ea.
P-763	100 psi (7 bar)	Tan	Red	125 μ L	ea.
P-764	250 psi (17 bar)	Tan	White	95 μ L	ea.
P-765	500 psi (34 bar)	Tan	Green	89 μ L	ea.
P-795	750 psi (52 bar)	Black	Blue	87 μ L	ea.
P-796	1,000 psi (69 bar)	Black	Green	83 μ L	ea.



Pressure Relief Valves

› Prevent system over-pressurization

Our Pressure Relief Valves are ideal for preventing system over-pressurization. These products protect system components by diverting fluid flow automatically when inline pressure exceeds the set limit. Choose between preset 100 psi (7 bar) and 5 psi (0.3 bar) assemblies, both shipped with Flangeless Fittings. The 100 psi version is a good, general purpose valve, while the 5 psi version is perfect for protecting syringe and peristaltic pump systems. The void volume of both relief valves is low due to the small 0.020" (0.50 mm) thru-holes in the valve tee body.

If you wish to have the Pressure Relief Valve open at a different pressure than 5 or 100 psi, simply combine one of the other replacement Back Pressure Regulator Assemblies listed on page 145 with the P-612 Pressure Relief Valve Tee. Choose the P-612S for larger bore tubing and higher flow applications.

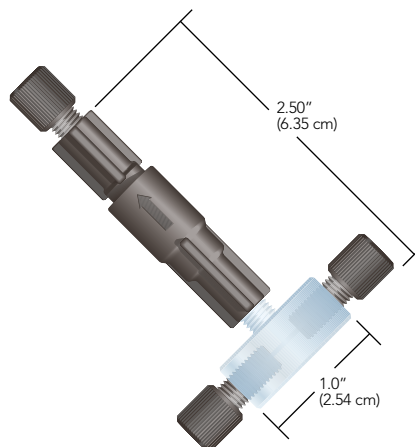

U-455

Pressure Relief Valve
Includes Flangeless Fittings
for 1/16" OD tubing
(Drawing is not actual size)

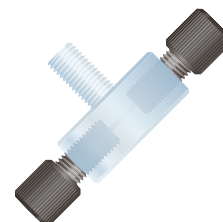

P-612

Pressure Relief Valve Tee
Includes Flangeless Fittings
for 1/16" OD tubing
(Drawing is not actual size)

Part No.	Description	Pressure Setting	Tubing OD	Includes	Swept Volume	Qty.
PRESSURE RELIEF VALVES						
U-455	Pressure Relief Assembly	5 psi (0.3 bar)	1/16"	XP-201	148 µL	ea.
U-456	Pressure Relief Assembly	100 psi (7 bar)	1/16"	XP-201, wrenches	139 µL	ea.
P-612	Pressure Relief Tee Only		1/16"	XP-201	14 µL	ea.
P-612S	Pressure Relief Tee Only		3/16"	XP-201	348 µL	ea.

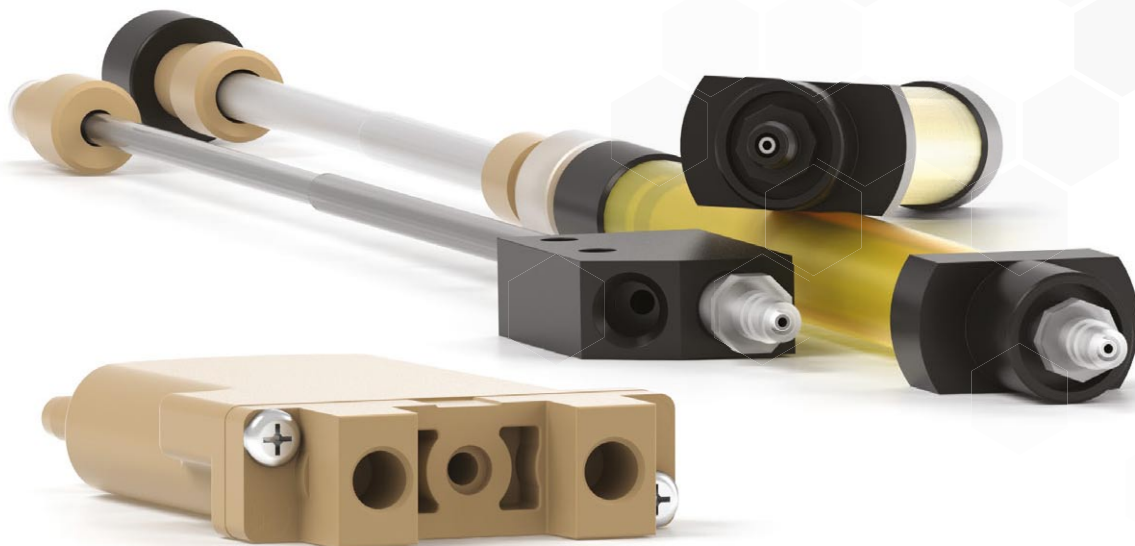

Degassers

Degassers improve fluidic instrument precision and reliability by removing dissolved gases from fluids before they outgas and form problem causing bubbles. Three main types of bubble removing products are available. AF based degassers offer the widest range of chemical compatibility and are used to eliminate retention shifts and baseline fluctuations. Silicone based degassers offer the highest flow rate capabilities for water based systems such as diagnostic and life science instrumentation to improve dispense accuracy and reliability. Poridex based products provide rapid bubble remove for locations where bubble introduction cannot be avoided.

151

DEBUBLERS

154

DEGASSING SYSTEMS

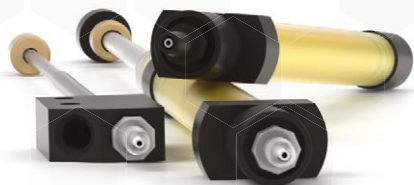

Debubblers



APPLICATION NOTE

- › Liquid handling
- › IVD
- › HPLC/UHPLC
- › O₂ and CO₂ removal

In medical analyzers, bubbles interfere with critical volumetric reagent dispenses and cause sample failures, wasting time and money. Because bubbles adhere to nearly every part of a dispensing system, high velocity or induced turbulent flow is often used to displace and discharge bubbles from the flow stream and into a waste area. These alternative processes waste reagents and are time consuming, unpredictable, and may additionally require designing the system to recognize bubbles are present. Regardless of how the systems are designed, aqueous systems will always be subject to the laws of physics that cause out-gassing during changes in fluid temperature, pressure, or chemicals mixture. In fluid applications like these, debubblers are the optimal solution to capture and remove formed bubbles to prevent sample dispense inaccuracies, and degassing is ideal to prevent downstream bubble formation from recurring.



BENEFITS

	ACTIVE DEBUBBLER	DEBUBBLER/DEGASSER	TRANSFER-LINE DEGASSER
Perfect for applications that require dissolved gas like oxygen for reaction kinetics	✓		
Improves dispense precision by capturing and removing bubbles	✓	✓	
Eliminates false positives and reduces reagent waste by improving instrument performance	✓	✓	
Easily integrates into fluidic path	✓	✓	✓
Creates stable instrument performance across system and environmental fluctuations	✓	✓	✓
Prevents the formation of bubbles downstream of the degasser		✓	✓
Eliminates fluctuations for improved detector sensitivity and accuracy by preventing bubble formation		✓	✓
Improves fluidic system reliability because coaxial design reduces the number of connections			✓
Flexible design can be implemented as transfer line in new instruments or existing instruments that don't have space available			✓
Minimizes fluidic system internal volumes to reduce reagent cost			✓

Remove Bubbles, Dissolved Gas, or Both!

Dissolved gases and bubbles in system liquids cause dispense volume anomalies in many instruments, negatively affecting both dispense precision and analytical accuracy. Now you have a choice of components for actively removing bubbles with or without also removing dissolved system gases. Online Vacuum Degassing offers operating convenience, high efficiency and low operating costs compared to other common degassing technologies.

Debubbler/Degasser

Combines Vacuum Degassing with Active Bubble Removal

- › Improves instrument performance — reduces downtime due to bubble formation.
- › Fewer false positives due to reduction of partial reagent dispenses.
- › Easily integrates into any pump, degassing tray, or stand-alone degassing application.
- › Designed for use with water based solutions with no surfactants. Active degassers are recommended for other solutions.

Active Debubbler

Remove Bubbles in Fluid Stream Before or After the Pump

- › Improves instrument performance — reduces downtime due to bubble formation.
- › Fewer false positives due to reduction of partial reagent dispenses.
- › Easily integrates into any pump, degassing tray, or stand-alone degassing application.

Transfer-Line Degasser

Removes Dissolved Gases During Fluid Transfer

- › Eliminates baseline fluctuations for improved detector sensitivity.
- › Coaxial design reduces number of connections, improves reliability.
- › Single lumen design increases degassing reliability.

Debubblers (Cont.)

Overall Dimensions Please note: These drawings are not actual size.

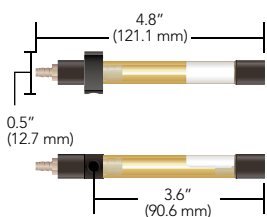

9000-1540
Active Debubbler, 2.5 mL

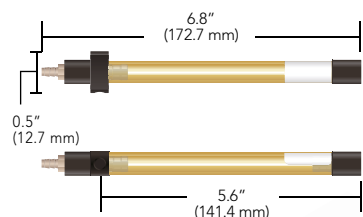

9000-1541
Active Debubbler, 5 mL

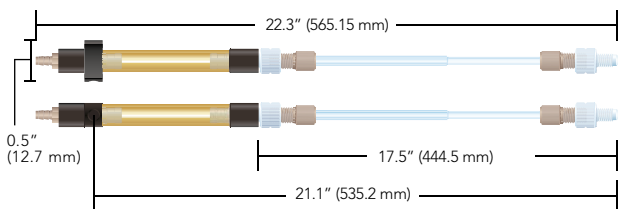

9000-1544
Debubbler / Degasser, 2.5 mL

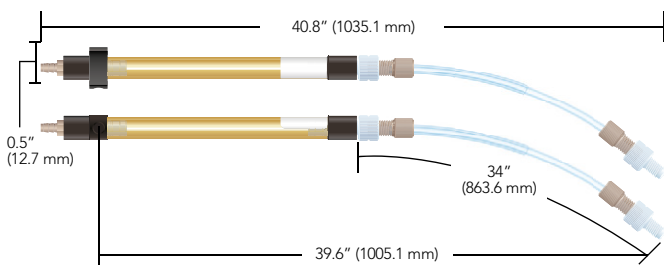

9000-1545
Debubbler/Degasser, 5 mL

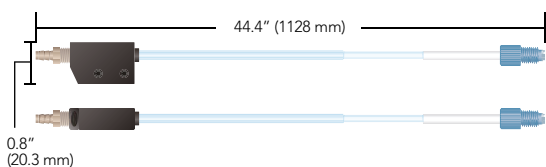

9000-1549
Transfer-Line Debubbler, 1.1 meter

IMPLEMENTATIONS

Typical Debubbler Implementation

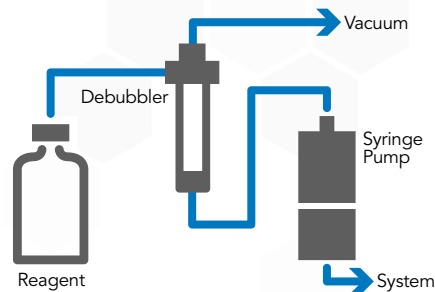

Transfer-Line Degasser Implementation

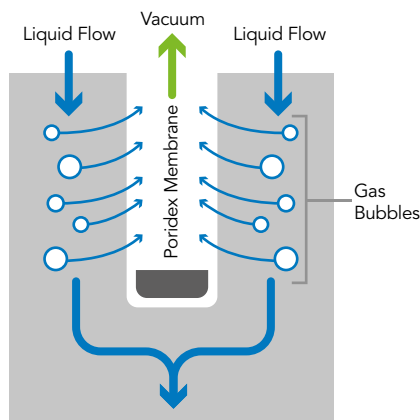
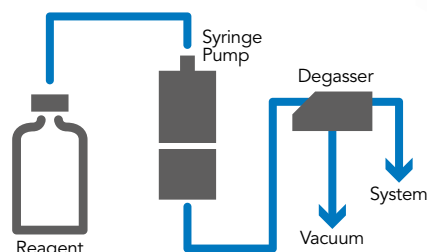

Gas bubbles are actively removed from a flowing liquid stream by vacuum via the PORIDEX membrane.

SPECIFICATIONS (ALL PLATFORMS)

	ACTIVE DEBUBLERS	DEGASSER/DEBUBLERS	200 KPA (30 PSI) @ 25 °C
Bubble Removal (volume of air removed/min @ 10 mL/min H₂O)	Up to 30 cc	Up to 30 cc	N/A
Degassing Efficiency @ 1 mL/min H₂O	N/A	2.5 mL size: 36% O ₂ removal, 5.0 mL size: 55% O ₂ removal	< 4 ppm dissolved O ₂ at 5 mL/min
Membrane Material	PORIDEX®	PORIDEX	PORIDEX
Wetted Materials	PORIDEX, Polyolefin, FEP, ETFE, Ultem®	PORIDEX, Polyolefin, FEP, ETFE, Ultem	PORIDEX, Polyolefin, FEP, ETFE
Solvent Compatibility	Solutions > 50% aqueous. Not compatible with detergent concentrations > 0.05%.	Solutions > 50% aqueous. Not compatible with detergent concentrations > 0.05%.	Solutions > 50% aqueous. Not compatible with detergent concentrations > 0.05%.
Standard Bubble Trap Volume	2.5 / 5.0 mL	2.5 / 5.0 mL	N/A
Transfer-Line Volume	N/A	2.5 / 5.0 mL	< 4 mL
Max. Operating Pressure	200 kPa (30 psi) @ 25 °C	200 kPa (30 psi) @ 25 °C	200 kPa (30 psi) @ 25 °C
Max. Operating Temperature	40 °C	40 °C	40 °C
Recommended Vacuum Level	Minimum 16 kPa absolute	Minimum 16 kPa absolute	Minimum 16 kPa absolute
Liquid Connection	1/4-28 fitting system	1/4-28 fitting system	1/4-28 fitting system
Vacuum Connection	Tubing vacuum port(s) for 1/8" (3 mm) ID elastomeric tubing	Tubing vacuum port(s) for 1/8" (3 mm) ID elastomeric tubing	Tubing vacuum port(s) for 1/8" (3 mm) ID elastomeric tubing
Pressure Drop	0.8 mm Hg / mL / min (assumes laminar flow and viscosity of 1 cP)	0.8 mm Hg / mL / min (assumes laminar flow and viscosity of 1 cP)	0.8 mm Hg / mL / min (assumes laminar flow and viscosity of 1 cP)

[†] Debubbling / degassing efficiency can be optimized based on flow rate, fluid to be degassed, and gas to be removed.

TYPICAL DEGASSER IMPLEMENTATION

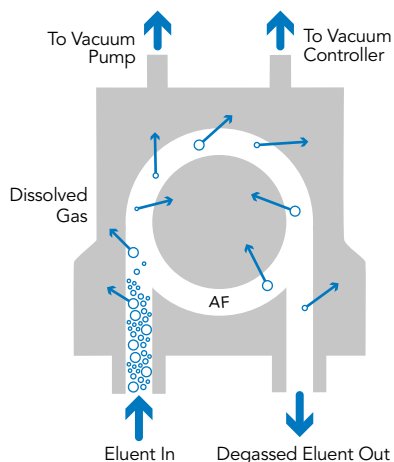
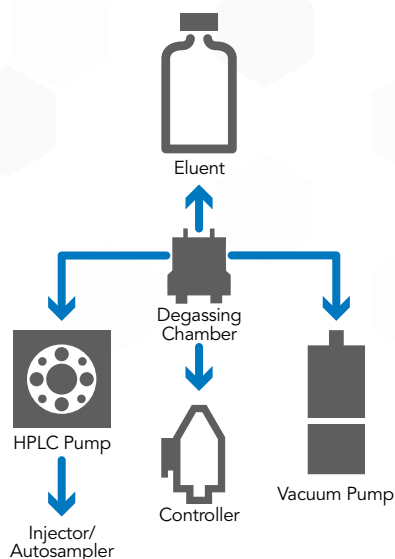

Dissolved gases are actively removed from a flowing liquid stream by vacuum via the IDEX Health & Science AF[®] membrane.

APPLICATION NOTE

Why Degas Your Mobile Phase?

Dissolved air in HPLC mobile phases can result in flow rate instability and baseline disturbance.

Flow rate instability: Non-degassed mobile phase can outgas in the pump head, causing bubbles to be formed and trapped inside the head or check valves. These bubbles can cause flow disturbances and pressure fluctuations, resulting in flow rate instability.

Baseline disturbance: As the mobile phase passes through the column, it experiences a large pressure drop. Non-degassed mobile phase can outgas due to this pressure differential, causing air bubbles to form. Air bubbles passing through or lodging in the flow cell cause detection disturbances, exhibited as baseline noise.

Why Use a Degassing System?

Helium sparging is a common means of degassing HPLC solvents. This method has its drawbacks, however. Helium tanks are expensive and bulky, and solvent backup and contamination are concerns. In addition, helium sparging can change the composition of a premixed mobile phase over time, due to the difference in the evaporation rates of mobile phase components.

In contrast, the IDEX Health & Science Degassing System has none of these drawbacks, and it is extremely fast and efficient at removing dissolved gases — more efficient than helium sparging or PTFE-based degassing systems.

Tubing Connections

We recommend ETFE tubing (page 27) be used to limit regassing of mobile phase between the degasser and your pump. ETFE is recommended because of its superior impermeability to gases (compared to PTFE, FEP, and PFA tubing). Applicable flangeless fittings for 1/8" OD tubing are found on page 45.

GPC and HFIP Applications

Standard degassing chambers, with PEEK bulkhead unions, are not recommended for GPC applications or for use with HFIP (hexafluoroisopropanol). Special GPC "hardened" versions are available. Please contact us for more information.

NOTE

Degassing tubing is flexible and therefore can be coiled to shorten the overall length or used to transfer the fluid within an instrument to the next desired location.

Debubblers

Part No.	Description	Standard Bubble Trap Size	Transfer Line Length	Internal Volume	Max Bubble Capacity	Qty.
DEBUBBLER SERIES – AVAILABLE STANDARD CONFIGURATION						
9000-1540	2.5 mL Active Debubbler	2.5 mL	—	2.5 mL	2.5 mL	ea.
9000-1541	5 mL Active Debubbler	5 mL	—	5 mL	5 mL	ea.
9000-1544	2.5 mL Debubbler/Degasser	2.5 mL	17.5" (444.5 mm)	2.5 mL in transfer line + 2.5 mL in bubble trap	2.5 mL	ea.
9000-1545	5 mL Debubbler/Degasser	5 mL	34" (863.6 mm)	5 mL in transfer line + 5 mL in bubble trap	5 mL	ea.
9000-1549	1.1 m Transfer-Line Degasser	—	1.1 m (43")	4 mL	N/A	ea.



Full Stand Alone Degassing Systems

- › Analytical and Prep scale models
- › Ultra-high degassing efficiency
- › Low volume, easy to prime
- › Patented control eliminates baseline fluctuations
- › Inert flow path
- › 5+ year lifetime

No Troubles with Bubbles Anymore!

– prevent bubble formation in your Fluidic System with BIOTECH DEGASi line of Degassers.



**GENERAL
PURPOSE**



**GPC
ELUENT**



**LIMITED
VOLUME**



**SEMI
PREP**

Systec AF™ Internal Volume	480 µl	480 µl	100 µl	925 µl
No of Channels				
Biocompatible Flow Path	Y	N	Y	Y
Approximate Max Flow Per Channel (ml/min)	3	3		6
Inner Dimension Flow Path (mm)				

SPECIFICATIONS

Part Number	Number of Channels	Internal Volume
BIOTECH DEGASI CLASSIC		
0001-6352-A	2	480 μ l
0001-6353-A	3	480 μ l
0001-6354-A	4	480 μ l
0001-6355-A	5	480 μ l
BIOTECH DEGASI GPC		
0001-6622	2	480 μ l
0001-6623	3	480 μ l
0001-6624	4	480 μ l
0001-6625	5	480 μ l
BIOTECH DEGASI MICRO		
0001-6352-S	2	100 μ l
0001-6353-S	3	100 μ l
0001-6354-S	4	100 μ l
0001-6355-S	5	100 μ l

Part Number	Number of Channels	Internal Volume
BIOTECH DEGASI SEMI-PREP		
0001-6352-L	2	925 μ l
0001-6353-L	3	925 μ l
0001-6354-L	4	925 μ l
0001-6355-L	5	925 μ l
BIOTECH DEGASI PREP		
0001-2053	2	
0001-6482	2	
0001-6484	2	
BIOTECH DEGASI PREP+		
0001-0120	1	
0001-0220	2	
0001-0420	4	
BIOTECH DEGASI COMPACT		
0004-2285	2	285 μ l
0004-4285	4	285 μ l
0004-6285	6	285 μ l
BIOTECH DEGASI HIGH FLOW		
HF.500-S Stand Alone	1	
HF.500-A OEM version	1	

Degasi Prep+ make it possible to degas organic solutions

More info at www.biotech.se

HIGH FLOW RATE
75 ml/min
Per channel



PREP



ORGANIC SOLVENTS



COMPACT APPLICATION



HIGH FLOW

Systec AF™ Internal Volume		285 μ l
No of Channels	2	1
Biocompatible Flow Path	Y	Y
Approximate Max Flow Per Channel (ml/min)		500
Inner Dimension Flow Path (mm)		

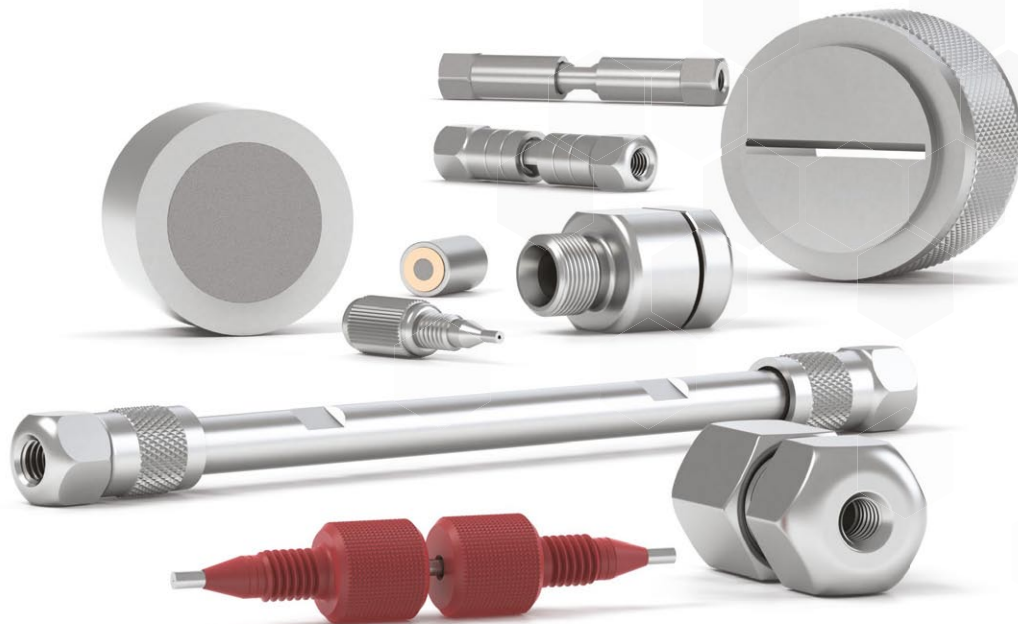

Column Hardware

We offer an extensive line of HPLC and UHPLC Column Hardware that has been optimized to enable selectivity, efficiency, and high-quality separation performance in your flow paths. To browse the full line of our column hardware portfolio please visit: www.idex-hs.com/column-hardware.html

- › Biocompatible materials for LC and UHPLC columns
- › Accessories for column protection and packing

Our line of column hardware includes protective accessories and connection products that enhance column functionality. Our columns come in a variety of sizes and materials to meet your system requirement.

157

GUARD HARDWARE

158

GUARD COLUMNS



Guard Hardware

Our Guard Hardware portfolio offers a variety of guard cartridges and holders to meet your system requirements. These include guards, guard holders, analytical cartridges, and tools designed to protect your system's valuable columns and help ensure high performance and excellent retention time.



Prep Scale Guard Holders

- › 21.2 mm and 30 mm ID column protection
- › Improves plate count and symmetry
- › New anti-rotation feature aids guard holder assembly

Iso-Prep™ Guard is a guard cartridge system designed to protect valuable prep columns. It offers superior column protection for adsorptive samples and a proven sample distribution mechanism via a precision machined holder. Iso-Prep Guard is ideal for protecting prep columns with no degradation of peak shape or plate count.

The high-performance guard protects columns in two ways. First, it acts as a filter, trapping particles in the frits. Second, when the guard cartridge is packed with the same material as the prep column, it removes compounds that irreversibly adsorb to the packing material.



Tools

Our tools includes the Iso-Prep Guard Scraper that is specifically designed as a tool used to dress a cartridge upon packing in order to set the frit at the correct depth.



APPLICATION NOTE

- › 60:40 Acetonitrile:Water
- › 50 mL/min
- › Kromasil 10 µm C18
- › Backpressure: 100 psi (7 bar)

10 µm C18 100 x 21.2 mm, 60:40 Acetonitrile:Water, 20 mL/min

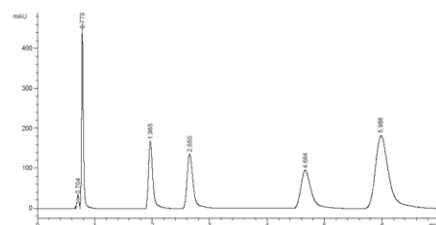

Without Iso-Prep Guard — 38,150 Plates/M 1.24 As

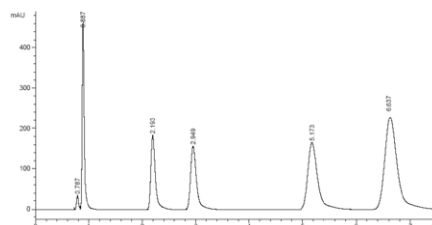

With Iso-Prep Guard — 41,920 Plates/M 1.20 As

Part No.	Description	Qty.
PREP SCALE GUARD HOLDERS		
9197-P	Iso-Prep Guard Holder	ea.
9197-P-AR	Iso-Prep Guard Holder, 21.2mm, Anti Rotation	ea.
9197-20	Iso-Prep Guard Cartridge, 21.2 mm x 1 cm, 1 Frit	ea.
9196-P	Iso-Prep Guard Holder, 30 mm	ea.
9196-P-AR	Iso-Prep Guard Holder, 30 mm, Anti Rotation	ea.
9196-20	Iso-Prep Guard Cartridge, 30 mm x 1 cm, 2 µm Frit	ea.
8083-MOD	Iso-Prep Guard, 30 mm Frit, 2 µm	ea.
TOOLS		
9197-S	Iso-Prep Guard Finishing Tool	ea.
9196-S	Iso-Prep Guard Finishing Tool, 30 mm	ea.



Guard Columns

We offer wide selection of pre-packed, cartridge style guard columns in addition to pack-it-yourself hardware. There are options for micro flow applications as well as analytical-scale applications. These guard columns can be immediately implemented into a system for your convenience.



Guard Column Kits

- › 100% biocompatible flow path
- › Pressure rated to 4,000 psi (276 bar)
- › Wetted materials are Titanium and PEEK
- › Reusable holder complete with fingertight fittings



Insert one of our analytical guard columns between the injection valve and column of your HPLC system to extend the life of your column and help ensure reproducible results. Convenient, prepacked PEEK polymer cartridges complete the system and are available in a variety of bonded phases to match your column chemistry held in place by Titanium frits.

The C-270 Stainless Steel Guard Column Holder is engineered for high-pressure applications to 4,000 psi (276 bar). Each of these holders is surface treated to prevent galling*, a potential problem with threaded metal parts.

The flow path of the C-270 Guard Column Holder is biocompatible. Each comes complete with fittings for 1/16" OD tubing, and can be used with any of the C-28X or C-7XX guard column cartridges listed on the following pages.

*Galling is a form of "cold welding." When two fittings manufactured from the same metal are wrench-tightened too tightly, they can "weld" together, making it virtually impossible to separate the two components.



Microbore Guard Columns

- › Ideal for Microbore HPLC
- › Easily dry packed (or slurry packed with adapter)
- › Made of PEEK polymer and stainless steel

This ultralow volume guard column (1.0 mm ID x 2 cm length) is ideal for narrow-bore chromatography. The unpacked guard column allows you to exactly match the chemistry of your column, resulting in optimum column protection. The total packing volume of 16.2 μL ensures maximum column efficiency and analytical column protection.

Frits often become plugged before a guard column is contaminated. The two 0.5 μm frits included with this guard column can be changed in minutes. Optional 2 μm frits may be purchased separately (C-408).



SPECIFICATIONS & DETAILS

Packing Material Specifications:
The cartridges on this page are packed with 5 μm or 10 μm base-deactivated 80 Å spherical silica.

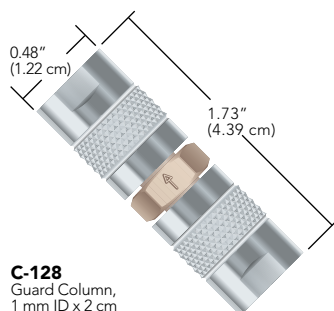



Analytical Guard Columns

- › Easy to pack

The C-130B is our most popular guard column. HPLC users find this column easy to pack and extremely economical. This narrow-bore short column (2.0 mm ID x 2 cm length) creates only a slight pressure increase with virtually no detectable theoretical plate loss when used with a 3 mm ID or larger column. The 2 μ m frits are easy to change, prolonging the life of the guard column. With only 62 μ L packing volume per guard column, a 3 g bottle of packing material will pack about 30 guard columns.

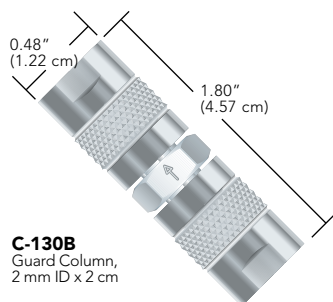

C-130B
Guard Column,
2 mm ID x 2 cm



Guard Column Holders

- › 10 mm ID column protection
- › Convenient cartridge system
- › Easy to pack

The internal volume of our semi-prep guard column is just 780 μ L, which only requires approximately 1.50 g of packing material — ideally the same material used in your semi-prep column. The C-1000 Holder will hold to high pressures, and is specially treated to prevent galling*. Use standard 10-32 coned fittings (not included) to connect your 1/16" OD tubing.

* Galling is a form of "cold welding." When two fittings manufactured from the same metal are wrench-tightened too tightly, they can "weld" together, making it virtually impossible to separate the two components.

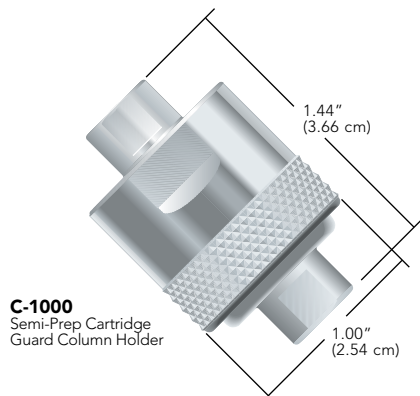

C-1000
Semi-Prep Cartridge
Guard Column Holder



C-1000 Semi-Prep Guard Column
Fittings, tubing, and column shown are not included.

Guard Columns (Cont.)



Accessories

Our accessories include packing adapters and seal, packing funnels, and other useful products to work with your column systems.

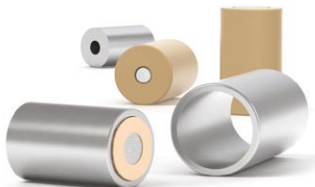

Guard Column Cartridges

Our biocompatible Guard Column Cartridges are conveniently prepackaged and are offered in multiple packs. We offer these cartridges in a variety of bonded phases to match your column chemistry. These cartridges are reusable and economical.



APPLICATION NOTE

Why Use A Guard Column?

A guard column can increase the life of your analytical column significantly. Use a guard column with the same packing as your column — it will act as a chemical filter, removing strongly retained materials in your sample that might otherwise contaminate your analytical column. And, it is more economical to replace a guard column cartridge than to buy a new analytical column.



RELATED PRODUCTS

- › All Guard Columns featured on this page include 10-32 Coned threads. Use any of the 10-32 coned fittings starting on page 32 to connect tubing to these guard columns.



APPLICATION NOTE

Signs Indicating the Guard Column Needs to be Changed

- › System pressure build-up
- › Faster than usual retention times
- › Reduced resolution

Guard Columns

Part No.	Description	Includes	Qty.
GUARD COLUMN KITS			
C-281	2.0 mm ID C18 Cartridges (6-pk) with (1) C-270 Assembly		ea.
MICROBORE GUARD COLUMNS			
1.0 mm ID x 2 cm Unpacked			
C-128	Guard Column	(2) C-128-31	ea.
C-128-31	0.5 µm Stainless Steel Replacement Frit		ea.
C-408	2 µm Stainless Steel Replacement Frit		ea.
ANALYTICAL GUARD COLUMNS			
2.0 mm ID x 2 cm Unpacked			
C-130B	Guard Column	(2) A-100	ea.
C-130-20	Packing Funnel		ea.
A-100	2 µm Stainless Steel Replacement Frit		ea.
A-103	0.5 µm Stainless Steel Replacement Frit		ea.
BIOCOMPATIBLE GUARD COLUMN HOLDERS			
10 mm ID x 1 cm			
C-270	High Pressure, Stainless Steel, with (2) F-200 Fittings, Biocompatible		ea.
GUARD COLUMN HOLDERS			
10 mm ID x 1 cm			
C-1000	Semi-Prep Cartridge Guard Column Holder		ea.
C-1035	Semi-Prep Cartridge		ea.
ACCESSORIES			
C-128-40	Slurry Packing Adapter		ea.
C-130-40	Slurry Packing Adapter		ea.
C-1030	Threaded Frit Cap with 2 µm Stainless Steel Frit		ea.
GUARD COLUMN CARTRIDGES			
2.0 mm ID x 1 cm, 10 µm Silica			
C-282	Reversed Phase C18		10-pk
4.3 mm ID x 1 cm, 5 µm Silica			
C-751	4.3 mm ID C18 Cartridges (6-pk) with (1) C-270 Assembly		ea.
C-752	Reversed Phase C18		10-pk

Educational Materials

Help is only a click away to access a wealth of product and application support information, including:

Chemical Compatibility

- › Use our compatibility charts to discover what materials are best suited for your application.

www.idex-hs.com/chemical-compatibility

Chromatography Forum

- › Browse or join this group that is devoted to the analytical and scientific communities.

www.idex-hs.com/chromatography-forum

Conversion Tools

- › Find useful Conversion Tools that allow you to easily convert temperatures, measurements, pressure ratings, and other functions.

www.idex-hs.com/conversions

FAQs

- › Explore our FAQs section to assist in finding the answers to issues you may be facing.

www.idex-hs.com/faqs

www.semrock.com/technical-faq.aspx

Fittings Primer

- › Learn the complexities and functions of nut- and ferrule fittings using our Fittings Primer.

www.idex-hs.com/fittings-primer

Glossary of Terms

- › Our Glossary of Terms provides a convenient list of definitions and/or explanations to language that is applicable in our industry.

www.idex-hs.com/glossary

HPLC Center

- › Visit our HPLC Center to learn about high- and ultra-high performance liquid chromatography.

www.idex-hs.com/hplc-center

Injectors Troubleshooting

- › This guide presents common problems when using manual sample injection valves.

www.idex-hs.com/injectors

IP Rating

- › Use our IP Rating chart to discover the environmental care of our electrical equipment.

www.idex-hs.com/ip-rating

Materials Guide

- › Our Materials Guide allows you to view material property and solvent compatibility.

www.idex-hs.com/materials-guide

Optical Filter Plotting Tool

- › Our SearchLight™ optical filter plotting tool allows you to easily select elements for your system, visualize the spectral properties, and quickly calculate critical parameters such as signal brightness, autofluorescence levels, and signal-to-noise ratio.

searchlight.semrock.com

Polymer Information

- › Study the Polymer Information chart to learn about analytical solvent compatibility for HPLC.

www.idex-hs.com/polymer-information

Pump School

- › Jump over to Pump School, an introduction to rotary positive-displacement (PD) pumps.

www.idex-hs.com/pump-school

Standard Port Drawings

- › We offer downloadable schematics of our Standard Port Drawings that allow you to easily create your own internal ports using our fittings.

www.idex-hs.com/standard-port-drawings

Tech Tips

- › Examine various topics that will maximize the precision performance of our products.

www.idex-hs.com/tech-tips

Webinars & Videos

- › IDEX Health & Science hosts ongoing educational webinars on specific topics, and has also created a product- and process-focused video library.

www.idex-hs.com/webinars-and-videos

Literature & Downloads

Our literature and downloads section provides a wide selection of valuable information about our products and our company. You can access and download a variety of support literature, manuals, designed to assist in the use of our products and services, including:

Operation Manuals & Instruction Cards

- › Product operation manuals and instruction cards are here for your convenience to download and use as reference.

www.idex-hs.com/manuals

Optical Filter Journals and White Paper Articles

- › Download and share our extensive collection of white papers and journal reprint articles written by our expert PhD staff. Browse varied topics, from coatings for ultrafast lasers, to polarization, super-resolution microscopy, tunable bandpass filters, and more.

www.semrock.com/tech-library.aspx

Optical Filter Technical Notes

- › Visit our General Filter information to learn more about the many optical filters we offer, how to find filter orientation, how to measure OD, and more.
- › Learn the basics of Fluorescence Filters, including different types of fluorescence filters, applications, uses, and information.
- › Our Raman & Laser Optical System Filters information pages give you an in-depth look into what you need to know and how to avoid issues integrating into your Raman & Laser Optical systems.

www.semrock.com/tech-notes.aspx

Optical Systems, Laser, & Shutter Technical Resources

Have a question or need some technical support? Consult our library of documentation, manuals, data sheets and specifications on our entire family of optical products, including:

- › Technical Note
- › White papers
- › Journal articles

www.mellesgriot.com/store/technical-library

Support Literature

- › Download informational IDEX Health & Science product and OEM catalogs, brochures, white papers, data sheets and more.

www.idex-hs.com/support-literature

Index by Part Number

0001-6352-A	154		
0001-6353-A	154		
0001-6354-A	154		
0001-6355-A	154		
0001-6622	154		
0001-6623	154		
0001-6624	154		
0001-6625	154		
0001-6352-S	154		
0001-6353-S	154		
0001-6354-S	154		
0001-6355-S	154		
0001-6352-L	154		
0001-6353-L	154		
0001-6354-L	154		
0001-6355-L	154		
0001-2053	155		
0001-6482	155		
0001-6484	155		
0001-0120	155		
0001-0220	155		
0001-0420	155		
0004-2285	155		
0004-4285	155		
0004-6285	155		
HF.500-S Stand Alone	155		
HF.500-A OEM version	155		
		1006-999	125
		1020-05	107
		1020-20	107
		1328	54
		1356	54
		1531	18
		1531B	18
		1532	18
		1533	18
		1534	18
		1535	18
		1536	18
		1538	18
		1544	18
		1560	18
		1561	18
		1568	18
		1569	18
		1570	18
		1571	18
		1572	18
		1574	18
		1576	18
		1577	18

1581	18	7020	127
1593	73	7021	127
1876	127	7022	127
1958-01	78	7023	127
1959-01	76	7024	127
3000	123	7025	127
3055-018	130	7026	127
3055-019	130	7027	127
3055-023	130	7028	127
3055-025	130	7029	127
3065-018	127	7030	123
3065-019	127	7030-003	125
3065-023	127	7030-014	125
3065-025	127	7030-015	125
3255	23	7030L	123
3505	23	7031-05	107
3725-006	125	7031-20	107
3725-018	125	7060	123
3725-038	123	7060-039	125
3725-999	125	7060-064	125
3725i	123	7060-065	125
3725i-038	123	7060-070	125
3755	23	7060-074	125
5001-999	125	7112-999	125
5100-999	125	7123-047	125
5104-999	125	7123-127	125
6000-076	66	7123-128	125
6000-078	61, 130	7123-142	125
6000-079	61, 130	7123-145	125
6000-082	33	7123-147	125
6000-083	33	7123-148	125
6000-209	33	7123-149	125
6000-210	33	7123-180	125
6000-211	33	7123-221	125
6000-251	61, 130	7123-223	125
6000-254	61, 130	7123-227	130
6000-255	61	7123-548	125
6000-262	33	7123-550	125
6000-282	32	7123-568	125
6000-360	61	7125-047	125
6255	23	7125-054	131
6505	23	7125-079	125
6755	23	7125-999	125
6810	51, 133	7150-999	125
7000	123	7152-999	125
7000-016	125	7155-999	125
7000L	123	7160	133
7004-999	125	7160-010	133
7010	123	7160-029	133
7010-039	125	7410-038	125
7010-040	125	7410-041	125
7010-069	125	7410-999	125
7010-071	125	7413-013	125
7010-997	125	7501-999	125
7010-998	125	7502-999	125
7010-999	125	7507-999	125
7012	131	7520-030	125

7520-035	125	9000-1549	153	62515	23
7520-999	125	9010	123	62520	23
7531-999	125	9010-051	125	62550	23
7650-002	125	9010-065	125	63005	23
7725	123	9010-999	125	65010	23
7725-010	125	9012	131	65015	23
7725-999	125	9013	131	65020	23
7725i	123	9055-020	130	65050	23
7725i-188	123	9055-021	130	67510	23
7750-038	125	9055-022	130	67515	23
7750-070	125	9055-023	130	67520	23
7755-015	130	9055-024	130	67550	23
7755-020	127	9055-025	130	79801-999	125
7755-021	127	9055-026	130	79861-999	125
7755-022	127	9055-027	130	310010	23
7755-023	127	9055-028	130	310015	23
7755-024	127	9055-029	130	310020	23
7755-025	127	9055-033	130	310050	23
7755-026	127	9085-05-10	106	315010	23
7755-027	127	9085-20-10	106	315015	23
7755-028	127	9125-043	125	315020	23
7755-029	127	9125-076	131	315050	23
7770-039	133	9125-082	125	610010	23
7770-040	133	9125-095	125	610015	23
7770-044	133	9125-999	125	610020	23
7770-124	133	9196-20	157	610050	23
7770-229	125	9196-P	157	615010	23
7788-999	125	9196-P-AR	157	615015	23
7900-146	125	9196-S	157	615020	23
7900-179	125	9197-20	157	615050	23
7900-183	125	9197-P	157	617515	23
7900-999	125	9197-P-AR	157	617520	23
7920-999	125	9197-S	157	617550	23
7960-014	125	9650-009	125	620015	23
7960-999	125	9725	123	620020	23
7961-999	125	9725-999	125	620050	23
7970-999	125	9725i	123	630010	23
7980-004	125	9750-021	125	630015	23
7980-999	125	9960-002	125	630020	23
7984-999	125	31005	23	630050	23
7986-004	125	31505	23	A-100	96, 104, 160
7986-999	125	32510	23	A-101	96, 106
8020	127	32515	23	A-102	96, 106
8021	127	32520	23	A-103	96, 160
8022	127	32550	23	A-105	96
8023	127	35010	23	A-106	96
8083-MOD	157	35015	23	A-107	96
8125	123	35020	23	A-120	96
8125-038	125	35050	23	A-122	96
8125-097	125	37510	23	A-224	96, 104
8125-098	125	37515	23	A-225	102
8125-119	125	37520	23	A-225A	102
8125-999	125	37550	23	A-227A	102
9000-1540	153	61005	23	A-228	102
9000-1541	153	61505	23	A-230A	102
9000-1544	153	62005	23	A-231A	102
9000-1545	153	62510	23	A-242	102

A-243	102	A-702	98	F-112	34
A-302	102	A-703	98	F-113	35
A-302A	102	A-704	98	F-120x	32
A-304	51	A-706	98	F-124Hx	34
A-305	51	A-707	98	F-124Sx	34
A-309	102	A-708	98	F-125Hx	34
A-310	102	A-710	98	F-125x	34
A-311	102	A-720	98	F-126Sx	34
A-311A	102	A-722	98	F-130x	32
A-313	104	A-735	110	F-132	34
A-314	104	B-310	88	F-142Nx	35, 37, 80
A-315	106	C-128	160	F-142x	35
A-318	106	C-128-31	96, 160	F-148	35
A-320	51	C-128-40	160	F-151	35
A-327	28	C-130-20	160	F-152	34, 132
A-328	28	C-130-40	160	F-152BLK	34
A-329	28	C-130B	160	F-156	41, 93
A-330	107	C-140-30	96	F-172	34
A-331	96, 107	C-235x	33, 38, 41	F-180	54
A-332	96, 107	C-236x	33	F-181	54
A-337	96, 107	C-270	160	F-182	54
A-343	96	C-281	160	F-183	54
A-350	28	C-282	160	F-184	54
A-355	106	C-401	96	F-185	54
A-356	106	C-402	96	F-186	54
A-360	107	C-407	96	F-187	54
A-410	107	C-408	96, 160	F-188	54
A-411	107	C-409	96	F-192x	36
A-420	96	C-420	96, 110	F-193x	36
A-427	101	C-425	96, 110	F-195x	36
A-428x	104	C-751	160	F-196x	36
A-429x	104	C-752	160	F-225	54
A-430	104	C-1000	160	F-226	54
A-431	104	C-1030	160	F-227	54
A-435	101	C-1035	160	F-228	54
A-437	101	CV-3000	135	F-229	54
A-438	101	CV-3001	135	F-230	54
A-440	101	CV-3010	135	F-231	54
A-441	101	CV-3301	136	F-232	54
A-445	101	CV-3302	136	F-233	54
A-446	101	CV-3315	136	F-234	54
A-451	101	CV-3316	136	F-237	54
A-510	107	CV-3320	138	F-238	54
A-520x	101	CV-3321	138	F-239	54
A-522x	101	CV-3322	138	F-240	54
A-550	101	CV-3323	138	F-241	54
A-551	101	CV-3324	138	F-242	54
A-610	111	CV-3325	138	F-243	54
A-620	111	CV-3330	138	F-244	54
A-622	111	CV-3335	138	F-245	54
A-626	112	CV-3336	138	F-246	54
A-627	112	CV-3340	138	F-247	54
A-628	112	CV-3500	137	F-252	54
A-629	112	D-646	93	F-252x	43
A-630	111	D-647	93	F-262x	28
A-700	98, 106	D-648	93	F-287x	36
A-701	98, 106	F-100x	32	F-300x	35

F-330x	35	M-548	109	P-207Sx	43
F-331x	35	M-550	110	P-207x	43
F-333Nx	37, 80	M-560	110	P-213	41
F-345	51	M-572	71	P-217	41
F-346	51	M-615-1	133	P-219	41
F-347	51	M-615-2	133	P-229x	41
F-350x	36	M-644-03x	41	P-232	41
F-354x	38	M-645x	32	P-240x	47
F-356x	41	M-650x	41	P-246x	41
F-364x	38, 41	M-652x	41	P-247x	43
F-374	54	M-653x	41	P-248x	41
F-375	54	M-655x	41	P-249x	41
F-376	54	M-660x	41	P-250x	41
F-381	54	MXP7900-000	119	P-255x	41
F-382	54	MXP7920-000	119	P-259	93
F-384	54	MXP7960-000	119	P-259x	41
F-385	54	MXP7970-000	119	P-260x	41
F-386	54	MXP7980-000	119	P-268	51
F-387	54	MXP7986-000	119	P-270x	99
F-388	54	MXP9900-000	119	P-272x	99
FS-110	18	MXP9960-000	119	P-273x	99
FS-115	18	MXT715-000	119	P-274x	99
FS-120	18	MXT715-102	119	P-275x	99
FS-150	18	MXT715-105	119	P-277	51
FS-175	18	MXX777-601	119	P-278	51
FS-315	28	MXX777-603	119	P-279	51
LT-100x	38	MXX777-605	119	P-281	41
LT-105x	41	MXX777-612	119	P-287	41
LT-110x	38	MXX777-616	119	P-291	51
LT-115x	41	MXX778-605	119	P-292	51
LT-132x	38	N-123-02	80	P-295	132
LT-200x	38	N-290	51	P-296	132
LT-210x	38, 41	N-291	51	P-297	51
LT-300	51	N-333	80	P-298	51
M-120x	108	OC-802	98, 107	P-299	51
M-121	109	OC-803	98, 107	P-300Nx	47
M-125	109	OC-805	98, 107	P-300x	43, 47
M-126	109	OC-815	98	P-307Sx	43
M-128	109	P-100	32	P-307x	43
M-131	109	P-116	34	P-309	55
M-133	109	P-120	55	P-311	55
M-134	109	P-123	55	P-312x	47
M-140x	108	P-133Nx	56	P-314	55
M-215	35	P-133x	56	P-316	55
M-250x	41	P-134	82	P-317	41
M-410	144	P-135	66	P-319	41
M-412	144	P-137x	41	P-321	55
M-420	144	P-140x	41, 56	P-329x	41
M-432	132	P-141x	41	P-331	41
M-432-03	132	P-150	81	P-336	41
M-447	79	P-154	81	P-337x	41
M-500	110	P-155	81	P-340x	47
M-510	110	P-170	70	P-342x	43
M-520	108	P-190	81	P-343x	43
M-525	108	P-191	81	P-344x	43
M-540	68	P-200Nx	47	P-347x	43
M-547	109	P-200x	43, 47	P-349x	41

P-350x.....	41	P-612S.....	148	P-703.....	85
P-352x.....	41	P-618.....	88	P-704.....	69
P-353x.....	43	P-619.....	88	P-710.....	85
P-355x.....	41	P-620.....	85	P-712.....	86
P-357-2x.....	41	P-622.....	85	P-713.....	86
P-357x.....	41	P-623.....	85	P-714.....	86
P-359.....	93	P-624.....	88	P-718.....	66
P-359x.....	41	P-625.....	88	P-719.....	88
P-360x.....	41	P-626.....	66	P-720.....	71
P-363Rx.....	43	P-627.....	66	P-721.....	142
P-366x.....	41	P-628.....	88	P-722.....	86
P-372x.....	99	P-629.....	88	P-723.....	86
P-373x.....	99	P-630.....	85	P-727.....	70
P-374x.....	99	P-631.....	85	P-728.....	70
P-381.....	41	P-632.....	86	P-729.....	70
P-387.....	41	P-633.....	86	P-732.....	142
P-399.....	51	P-634.....	86	P-733.....	142
P-401x.....	44	P-635.....	86	P-742.....	69
P-407x.....	44	P-642.....	88	P-754.....	55
P-416.....	34, 57	P-645.....	85	P-755.....	55
P-416BLK.....	34, 57, 132	P-646.....	93	P-756.....	55
P-416G.....	34	P-647.....	93	P-757.....	93
P-420.....	41, 93	P-648.....	93	P-760.....	69
P-430.....	82	P-650.....	66	P-761.....	147
P-432.....	82	P-652.....	66	P-762.....	147
P-440.....	82	P-654.....	66	P-763.....	147
P-441.....	82	P-655.....	88	P-764.....	147
P-441N.....	82	P-656.....	88	P-765.....	147
P-445.....	141	P-657.....	88	P-767.....	93
P-446.....	141	P-658.....	88	P-770.....	78
P-447.....	141	P-659.....	88	P-771.....	71
P-450.....	140	P-660.....	88	P-772.....	71
P-451.....	140	P-661.....	88	P-775.....	68
P-455.....	145	P-662.....	88	P-777.....	68
P-460S.....	140	P-663.....	93	P-779.....	69
P-460T.....	140	P-668.....	93	P-782.....	142
P-465.....	146	P-669-01.....	66	P-783.....	142
P-470.....	140	P-670.....	66	P-785.....	145
P-482BLK.....	44	P-671.....	66	P-786.....	145
P-501x.....	44	P-672.....	66	P-787.....	145
P-507x.....	44	P-673.....	66	P-788.....	145
P-512.....	83	P-675.....	88	P-789.....	145
P-513.....	83	P-677.....	88	P-790.....	145
P-514.....	83	P-678.....	88	P-791.....	145
P-515.....	83	P-680.....	88	P-794.....	93
P-520.....	55	P-681.....	66	P-795.....	147
P-550.....	55	P-683.....	88	P-796.....	147
P-551.....	55	P-684.....	66	P-797.....	93
P-553.....	71	P-686.....	88	P-798.....	93
P-554.....	78	P-689.....	93	P-799.....	93
P-555.....	34, 55	P-691.....	93	P-801.....	93
P-556.....	55	P-692.....	93	P-802.....	93
P-558.....	55	P-694.....	66	P-830.....	89
P-602.....	85	P-696.....	139	P-830T.....	89
P-603.....	85	P-697.....	139	P-831.....	89
P-604.....	88	P-699.....	139	P-835.....	89
P-612.....	148	P-702.....	85	P-836.....	89

P-837	89	PK-100x	58	U-160	21
P-838	89	PK-110x	58	U-161	21
P-840	42	PK-112	57	U-162	21
P-842x	42	PK-120BLKx	58	U-163	21
P-844x	42	PK-126Hx	58	U-164	21
P-845-01	85	PK-126x	58	U-165	21
P-846x	42	PK-132x	58	U-320x	33
P-849	55	PK-152	57	U-321x	33
P-850	93	U-101	21	U-322	73
P-851	93	U-102	21	U-400x	33
P-852	93	U-103	21	U-401x	33
P-854	93	U-104	21	U-402	73
P-857	93	U-105	21	U-410x	33
P-858	93	U-106	21	U-411	73
P-859	93	U-107	21	U-412	73
P-860	93	U-108	21	U-428	72
P-861	93	U-111	21	U-429	72
P-862	93	U-112	21	U-430	72
P-863	93	U-113	21	U-431	72
P-864	93	U-114	21	U-435	73
P-870	93	U-115	21	U-438	73
P-872	93	U-116	21	U-450x	33
P-874	71	U-117	21	U-455	148
P-875	68	U-118	21	U-456	148
P-880	145	U-126	21	U-466	68
P-881	78	U-127	21	U-466S	68
P-882	78	U-128	21	U-467R	55
P-885	68	U-129	21	U-469	146
P-887	68	U-130	21	U-500	66
P-888	68	U-131	21	U-504	66
P-889	68	U-132	21	U-510	66
P-890	68	U-133	21	U-514	66
P-891	68	U-134	21	U-605	145
P-920-01	66	U-135	21	U-606	145
P-930x	42	U-136	21	U-607	145
P-931x	42	U-137	21	U-608	145
P-938x	42	U-138	21	U-609	145
P-940x	42	U-139	21	U-610	145
P-942x	42	U-140	21	U-650x	56
P-945x	42	U-141	21	U-659	66
P-946x	42	U-142	21	U-660x	56
P-948x	42	U-143	21	U-665	66
P-982BLKx	44	U-144	21	U-800	21
P-1000	51	U-145	21	U-803	21
P-1082BLKx	44	U-146	21	U-805	21
P-1087x	44	U-147	21	U-825	21
PD715-000	120	U-148	21	U-1114	20
PD715-102	120	U-149	21	U-1115	20
PD715-105	120	U-150	21	U-1116	20
PD7900	120	U-151	21	U-1117	20
PD7920	120	U-152	21	U-1120	20
PD7960	120	U-153	21	U-1122	20
PD7970	120	U-154	21	U-1125	20
PD7980	120	U-155	21	U-1126	20
PD7986	120	U-156	21	U-1128	20
PD9900	120	U-157	21	U-1130	20
PD9960	120	U-158	21	U-1131	20

U-1132.....	20	UPFP-6300350.....	49	VHP-505.....	104
U-1133.....	20	UPFP-6300500.....	49	VHP-506.....	104
U-1140.....	20	UPFP-6300600.....	49	VHP-550.....	106
U-1141.....	20	UPFS-6100070.....	49	VHP-551.....	106
U-1142.....	20	UPFS-6100150.....	49	VHP-555.....	106
U-1143.....	20	UPFS-6100250.....	49	VHP-556.....	106
U-1145.....	20	UPFS-6100350.....	49	VHP-600.....	55
U-1146.....	20	UPFS-6100500.....	49	VHP-700x.....	59
U-1148.....	20	UPFS-6100600.....	49	VHP-920x.....	60
UH-402.....	73	UPFS-6125070.....	49	VHP-1000.....	51
UH-427.....	74	UPFS-6125150.....	49	VHP-1001.....	60
UH-432.....	76	UPFS-6125250.....	49	VHP-2000.....	51
UH-436.....	76	UPFS-6125350.....	49	VHP-3200.....	60
UH-630.....	78	UPFS-6125500.....	49	VHP-4000.....	51
UH-631-01.....	78	UPFS-6125600.....	49	VHP-9000.....	51
UH-632.....	76	UPFS-6254070.....	49	XF-358x.....	47
UH-634.....	78	UPFS-6254150.....	49	XF-368x.....	47
UH-700.....	74	UPFS-6254250.....	49	XLT-111x.....	47
UH-750.....	74	UPFS-6254350.....	49	XP-130x.....	56
UH-752.....	74	UPFS-6254500.....	49	XP-131x.....	56
UH-753.....	78	UPFS-6254600.....	49	XP-132x.....	56
UH-904x.....	58	V-100D.....	123	XP-136x.....	56
UH-906.....	78	V-100L.....	123	XP-137x.....	56
UP-700.....	69	V-100T.....	123	XP-141x.....	56
UPFP-6025070.....	49	V-101D.....	123	XP-201x.....	47
UPFP-6025150.....	49	V-101L.....	123	XP-202x.....	47
UPFP-6025250.....	49	V-101T.....	123	XP-218x.....	47
UPFP-6025350.....	49	V-240.....	123	XP-230x.....	47
UPFP-6025500.....	49	V-241.....	123	XP-235x.....	47
UPFP-6025600.....	49	V-340.....	123	XP-238x.....	47
UPFP-6050070.....	49	V-341.....	123	XP-245x.....	47
UPFP-6050150.....	49	V-447.....	132	XP-286x.....	47
UPFP-6050250.....	49	V-450.....	123	XP-301x.....	47
UPFP-6050350.....	49	V-451.....	123	XP-302x.....	47
UPFP-6050500.....	49	V-540.....	123	XP-305x.....	47
UPFP-6050600.....	49	V-541.....	123	XP-308x.....	47
UPFP-6075070.....	49	VHP-200-01x.....	59	XP-315x.....	47
UPFP-6075150.....	49	VHP-200x.....	59	XP-330x.....	47
UPFP-6075250.....	49	VHP-320x.....	60	XP-335x.....	47
UPFP-6075350.....	49	VHP-325x.....	60	XU-620x.....	56
UPFP-6075500.....	49	VHP-500.....	104	XU-655x.....	56
UPFP-6075600.....	49	VHP-501.....	104	XU-662x.....	56
UPFP-6100070.....	49				
UPFP-6100150.....	49				
UPFP-6100250.....	49				
UPFP-6100350.....	49				
UPFP-6100500.....	49				
UPFP-6100600.....	49				
UPFP-6150070.....	49				
UPFP-6150150.....	49				
UPFP-6150250.....	49				
UPFP-6150350.....	49				
UPFP-6150500.....	49				
UPFP-6150600.....	49				
UPFP-6300070.....	49				
UPFP-6300150.....	49				
UPFP-6300250.....	49				



TRADEMARKS & REGISTERED TRADEMARKS

For a complete list of IDEX Health & Science registered trademarks and their proper attribution, please refer to our trademarks list at: www.idex-hs.com/trademarks

LOCAL DISTRIBUTOR

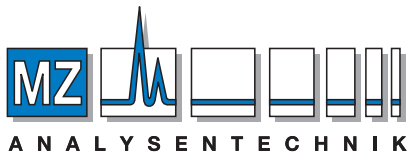

A N A L Y S E N T E C H N I K

AUTHORIZED DISTRIBUTOR

MZ-Analysentechnik GmbH
Barcelona-Allee 17 • D-55129 Mainz
Tel +49 6131 880 96-0
Fax +49 6131 880 96-20
e-mail: info@mz-at.de
www.mz-at.de



For ordering and technical support, please contact:

EUROPE | BIOTECH AB | +46 (0)300-56 91 80 | info@biotech.se | www.biotech.se
USA | BIOTECH USA LLC | 612-703-5718 | sales@biotechusa.us | www.biotech.se
JAPAN | BIONIK INC. | +81 545-38-9125 | info@bionikinc.com | www.bionikinc.com