

Hamilton Reference Guide
**HPLC Columns
and Accessories**





HPLC Columns and Accessories

Introduction	4	HPLC Columns	
Choosing HPLC Products	6	Technical Reference	41
HPLC 101.....	10	Care and Storage.....	42
Separation Mechanisms.....	11	Precautions in Column Care.....	42
How to Choose Column Specifications.....	12	Cleaning and Restoration.....	42
Column Accessories.....	13	Storage.....	43
Custom Columns.....	13	Resin Specifications.....	44
Reversed-Phase		Reversed-Phase Resins.....	44
Chromatography Columns	14	Anion Exchange Resins.....	45
Polymer-Based Resins.....	16	Cation Exchange Resins.....	45
PRP-C18.....	17	Ion Exclusion Resins.....	45
PRP-1.....	18	Useful Calculations.....	46
PRP-3.....	19	Retention Factor.....	46
PRP-h5.....	21	Selectivity.....	46
Silica-Based Resins.....	22	Plate Count.....	46
HxSil C8 and HxSil C18.....	23	Tailing Factor.....	47
Ion Chromatography Columns	24	Maximum Column Load.....	47
Anion Exchange Columns.....	26	Resolution.....	47
PRP-X100 and PRP-X110/S.....	27	Index	48
PRP-X500.....	29		
PRP-X600.....	30		
RCX-10.....	31		
RCX-30.....	32		
Specialty Anion Exchange Columns.....	33		
Cation Exchange Columns.....	34		
PRP-X200.....	35		
PRP-X400.....	36		
PRP-X800.....	37		
HC-40 and HC-75.....	38		
Ion Exclusion Columns.....	39		
PRP-X300.....	39		







HPLC Columns and Accessories

Hamilton's commitment to chromatography expanded into HPLC columns about 35 years ago. Hamilton was one of the first companies to understand the unique qualities of polymer-based columns and how the technology could advance the field of HPLC. Following significant research and advancements by its team of engineers and scientists, Hamilton's first line of pressure-stable, polymeric HPLC columns was created, making it a pioneer in the development and manufacturing of polystyrene-divinylbenzene (PS-DVB) polymers

for HPLC applications. Today Hamilton offers 21 different HPLC column packings for four different modes of separation. All Hamilton columns are made and tested in house to ensure the highest quality products. In this reference guide you will find all of the information needed to choose the Hamilton column best suited to your needs and how to care for your column of choice. The technical references also include useful calculations for analyzing chromatographic data.



Introduction

These pages can be used to determine the best Hamilton HPLC products for a given application by separation mechanism, molecular weight of analyte, USP listing, or detector.



Introduction

P. 6

Reversed-Phase Chromatography Columns

This section contains both polymeric and silica resins.



Reversed-Phase Chromatography Columns

P. 14

Ion Chromatography Columns

Turn to this section for anion exchange, cation exchange, and ion exclusion resins.



Ion Chromatography Columns

P. 24

HPLC Columns and Accessories Technical Reference

Information on care and storage, resin specifications, and common calculations can be found here.

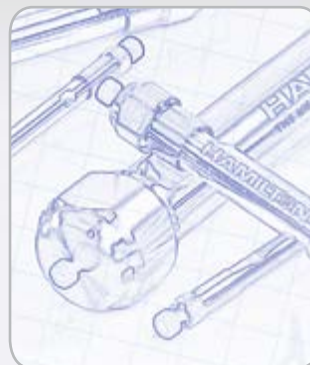

HPLC Columns and Accessories Technical Reference

P. 41

Choosing HPLC Products

Which columns are available for the separation mechanism I need?

Hamilton offers HPLC columns designed for reversed-phase, anion exchange, cation exchange, and ion exclusion separations. If the desired separation mechanism is known, use the following chart to find columns of that type. If the desired separation mechanism is not known, see HPLC 101 or one of the other decision trees.

Products by Separation Mechanism

Separation Mechanism		Model	Page
Adsorption Chromatography	Reversed-Phase	PRP-C18, PRP-1, PRP-3, PRP-h5, HxSil C18, HxSil C8	P. 17, P. 18, P. 19, P. 21, P. 23, P. 23
Ion Exchange Chromatography	Anion Exchange	PRP-X100, PRP-X110, PRP-X500, PRP-X600, RCX-10, RCX-30	P. 27, P. 27, P. 29, P. 30, P. 31, P. 32
	Cation Exchange	PRP-X200, PRP-X400, PRP-X800, HC-75, HC-40	P. 35, P. 36, P. 30, P. 32, P. 38
Ion Exclusion Chromatography	Ion Exclusion	PRP-X300	P. 39



Which column is right for the molecular weight of my analyte?

Use the following flow chart to determine the best-suited column resin for a given molecular weight of analyte. Go to the corresponding page number(s) for more information.

Products by Molecular Weight

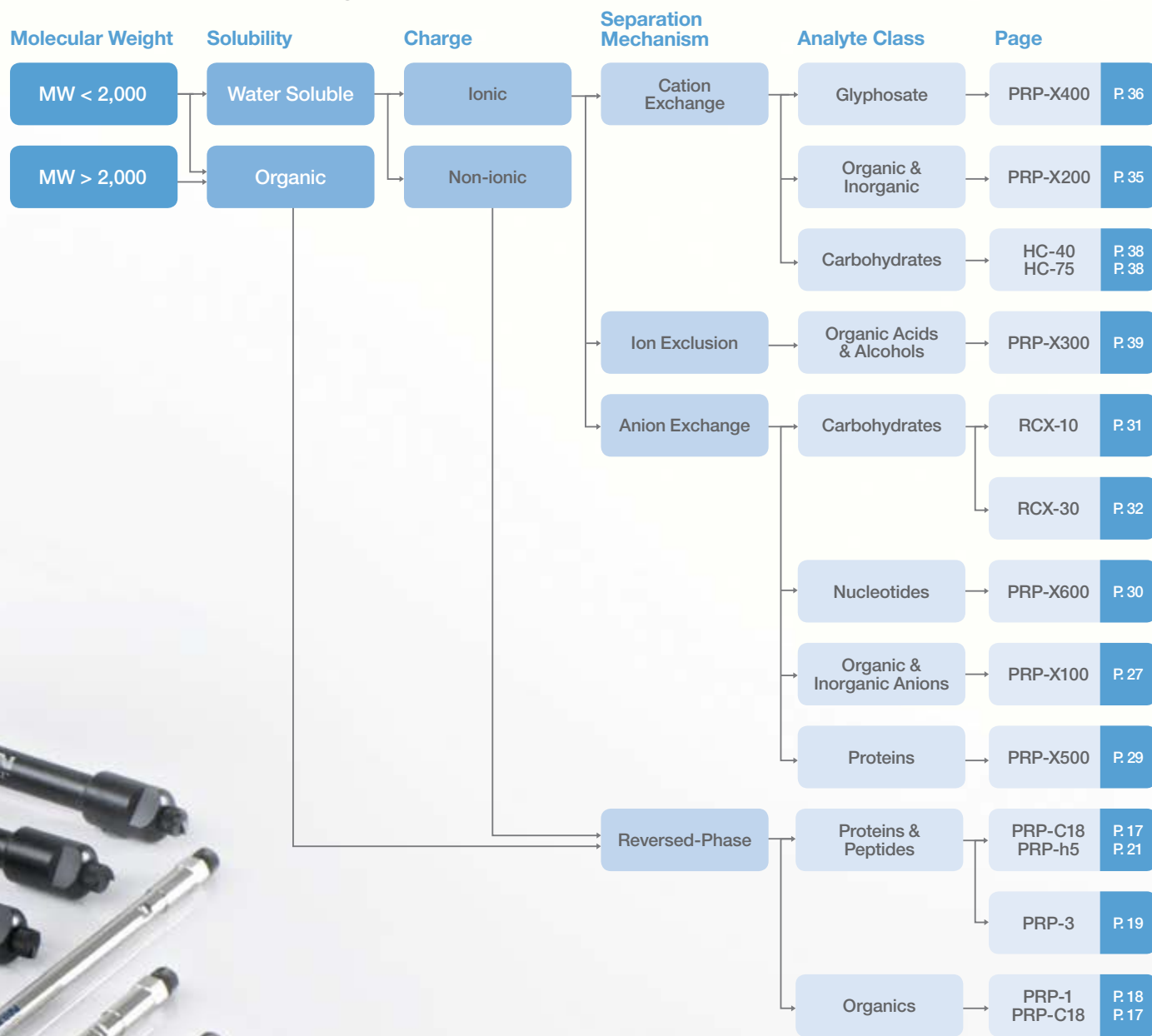



Which columns work with my required USP listing?

This list can be used to identify the Hamilton column equivalents to United States Pharmacopeial Convention (USP) listings.

USP Listing	Description	Hamilton Columns	Page
L1	Octadecylsilane chemically bonded to porous silica or ceramic micro-particles, 1.5 to 10 μm in diameter, or a monolithic rod.	HxSil C18	P. 23
L7	Octylsilane chemically bonded to totally porous or superficially porous silica particles 1.5 to 10 μm in diameter, or a monolithic rod.	HxSil C8	P. 23
L17	Strong cation-exchange resin consisting of sulfonated cross-linked styrene-divinylbenzene copolymer in the hydrogen form, 6 to 12 μm in diameter	HC-75 H ⁺ PRP-X200 PRP-X300	P. 38 P. 35 P. 39
L19	Strong cation-exchange resin consisting of sulfonated cross-linked styrene-divinylbenzene copolymer in the calcium form, 5 to 15 μm in diameter	HC-40 Ca ⁺² HC-75 Ca ⁺²	P. 38 P. 38
L21	A rigid, spherical styrene-divinylbenzene copolymer, 3 to 30 μm in diameter	PRP-1 PRP-3	P. 18 P. 19
L22	A cation-exchange resin made of porous polystyrene gel with sulfonic acid groups, 5 to 15 μm in diameter	PRP-X200 PRP-X300	P. 35 P. 39
L23	An anion-exchange resin made of porous polymethacrylate or polyacrylate gel with quaternary ammonium groups, 7 to 12 μm in size	PRP-X500	P. 29
L34	Strong cation-exchange resin consisting of sulfonated cross-linked styrene-divinylbenzene copolymer in the lead form, 7 to 9 μm in diameter	HC-75 Pb ⁺²	P. 38
L47	High capacity anion-exchange microporous substrate, fully functionalized with trimethylamine groups, 8 μm in diameter	PRP-X100, PRP-X110/S, RCX-10, RCX-30	P. 27, P. 27, P. 31, P. 32



Which columns are compatible with my detector?

There is often little flexibility in detector choice. Use this list for examples of which columns are compatible with certain detectors. It is important to note that this list is not complete, only representative, and that more important than column compatibility is analyte compatibility with detectors.

Detector	Compatible Columns	Page
Atomic Fluorescence	PRP-X100	P. 27
Conductivity	PRP-C18, PRP-1, PRP-3, PRP-h5, HxSil C8, HxSil C18, PRP-X100, PRP-X110/S, PRP-X200, PRP-X400, PRP-X800, PRP-X300	P. 17, P. 18, P. 19, P. 21, P. 23, P. 23, P. 27, P. 27, P. 35, P. 36, P. 37, P. 39
Direct Current Amperometric	PRP-X100, PRP-X110/S	P. 27, P. 27
Fluorescence	PRP-C18, PRP-1, PRP-3, PRP-h5, HxSil C8, HxSil C18, PRP-X400	P. 17, P. 18, P. 19, P. 21, P. 23, P. 23, P. 36
ICP-MS	PRP-X100, PRP-X110/S	P. 27, P. 27
Indirect Conductivity	PRP-X100, PRP-X110/S, PRP-X200, PRP-X800	P. 27, P. 27, P. 35, P. 37
Indirect UV	PRP-X100, PRP-X110/S, PRP-X200, PRP-X800	P. 27, P. 27, P. 35, P. 37
MS	PRP-C18, PRP-1, PRP-3, PRP-h5, HxSil C8, HxSil C18	P. 17, P. 18, P. 19, P. 21, P. 23, P. 23
Pulsed Amperometric	PRP-X100, PRP-X110/S, RCX-10, RCX-30, PRP-X400	P. 27, P. 27, P. 31, P. 32, P. 36
Refractive Index	PRP-C18, PRP-1, PRP-3, PRP-h5, HxSil C8, HxSil C18, PRP-X100, PRP-X110/S, RCX-10, RCX-30, PRP-X400, HC-40, HC-75 Ca ⁺² , HC-75 H ⁺ , HC-75 Pb ⁺² , PRP-X300	P. 17, P. 18, P. 19, P. 21, P. 23, P. 23, P. 27, P. 27, P. 31, P. 32, P. 36, P. 38, P. 38, P. 38, P. 38, P. 39
UV	PRP-C18, PRP-1, PRP-3, PRP-h5, HxSil C8, HxSil C18, PRP-X100, PRP-X110/S, PRP-X500, PRP-X600, PRP-X200, PRP-X400, HC-75 H ⁺ , PRP-X300	P. 17, P. 18, P. 19, P. 21, P. 23, P. 23, P. 27, P. 27, P. 29, P. 30, P. 35, P. 36, P. 38, P. 39
Visible	PRP-C18, PRP-1, PRP-3, PRP-h5, HxSil C8, HxSil C18, PRP-X800	P. 17, P. 18, P. 19, P. 21, P. 23, P. 23, P. 37



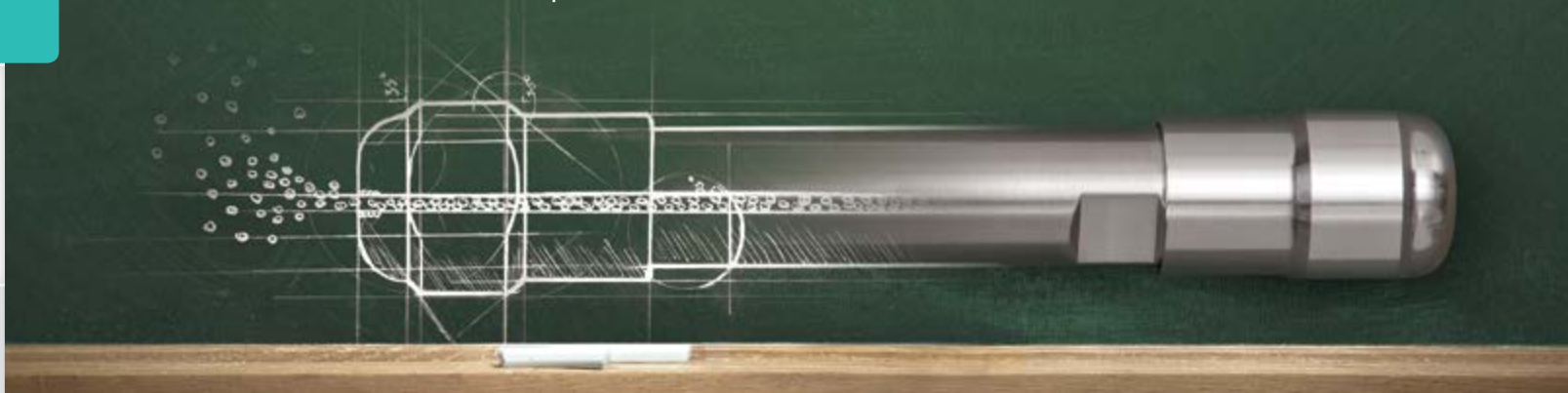

HPLC 101

This section is designed to guide decisions necessary for column selection. It includes information on each parameter that goes into choosing a column to ensure that you make the best choice for your needs.

Separation Mechanisms

Reversed-Phase, Ion Exchange, Exchange Capacity, Ion Exclusion

P. 11

How to Choose Column Specifications

Scale of Separations, How to Choose PEEK or Stainless Steel Hardware, Column Length, Column Diameter, Particle Size

P. 12

Column Accessories

Why to Use a Guard Column, Bulk Resin, Column Hardware

P. 13

Custom Columns

P. 13



Separation Mechanisms

Reversed-Phase

The reversed-phase separation mechanism is based on the relative hydrophobicities of the components in a sample mixture. The stationary phase is highly hydrophobic. The mobile phase is significantly less hydrophobic than the stationary phase, resulting in preferential retention of more hydrophobic sample components. Reversed-phase HPLC is useful for moderately polar compounds.

Ion Exchange

Ion exchange is a separation mechanism based on the relative ionic strengths of the components in a sample mixture. The stationary phase is a charged material that will preferentially retain species with the opposing charge. This mechanism is useful for separating species of like charge, since charged species compete to pair with the opposing charge of the column. Anion exchange HPLC has a positively charged stationary phase that retains negatively charged species. The opposite is true for cationic exchange. Elution in ion chromatography is affected by mobile phase pH and ionic-strength, and to a lesser extent, operation temperature. The ability to use the full pH range and elevated temperatures are distinct advantages of Hamilton ion exchange columns compared to silica-based supports. Ion chromatography greatly reduces sample pretreatment and improves the accuracy and precision of results.

■ Exchange Capacity

Ion exchange capacity is a measurement of the number of positive charges (cations) or negative charges (anions) that the exchange resin can bind to and is reported in singly charged ion equivalents per 1 gram of resin. Exchange capacity is dependent upon the pH of the mobile phase and in anion exchange chromatography; as mobile phase acidity decreases (pH increases), the exchange capacity decreases. In cation exchange chromatography, the inverse is true.

Ion Exclusion

Ion exclusion chromatography is a technique applied to separate ionic from nonionic compounds and mixtures of organic acids and alcohols. The electric charge sign of the dissociated functional groups of the ion exchange resin is the same as the electric charge sign of the analyzed ionic compound, excluding them from the pores of the support resin and eluting first while the nonionic species elute later.



How to Choose Column Specifications

Scale of Separations: Analytical, Preparative, or Semi-Preparative Column

The sample amount needed to be purified or separated for analysis will dictate which scale of chromatography is needed. In general, the scales of chromatography are microbore, analytical, semi-preparative, and preparative. Nanoscale and microscale are smaller scale ranges but are not covered in Hamilton's product offerings. Columns with inside diameters of 1.0 mm to 2.1 mm can be classified as microbore, 4.0 mm to 4.6 mm as analytical, 7.0 mm to 10 mm as semi-preparative, and 21.2 mm and higher as preparative. Hamilton lists both microbore and analytical scale products as "analytical" products.

Required sample loading needs to be considered for determining which scale to use. A good starting point is that a 4.1 x 150 mm HPLC column packed with 5 µm PS-DVB particles will typically be able to bind up to 10 mg of sample on a Hamilton column. With this in mind, a linear scale up or down can be calculated to determine which column size is needed for more or less sample.

The scale of chromatography needed for a given application will determine the appropriate column hardware size and particle size.

Scale	Column Tube ID (mm)	Particle Size (µm)
Microbore	1.0 – 2.1	5
Analytical	4.0 – 4.6	5 or 7
Semi-preparative	7.0 – 10	10, 12 – 20
Preparative	> 21.2	12 – 20, 30 – 50

It may be necessary to increase the size of a chromatography column in order to increase the production capacity of a process. When scaling a separation from microbore to analytical, or analytical to semipreparative or preparative scale, it is important to maintain linear flow rates. This ensures that gradients are accurately replicated with increased scale, thus maintaining the desired elution time of analytes. As the sample amount and flow rate are increased with increasing scale, the particle size of the stationary phase will also need to be increased to prevent overpressuring the system.

Scale-Up Calculations

Column hardware scale-up based on sample loading:

$$\left(\frac{load_2}{load_1}\right) = \left(\frac{radius_2}{radius_1}\right)^2$$

Linear scale-up flow rate calculation:

$$\frac{volume\ flow_2}{volume\ flow_1} = \frac{load_2}{load_1}$$



How to Choose PEEK or Stainless Steel (SS) Hardware

Hamilton offers both stainless steel and PEEK column hardware options. PEEK is typically used in cases where biocompatibility is a serious concern. Stainless steel hardware is unlikely to leach into samples, but PEEK can be used to further reduce the likelihood of leaching.

Column Length

Column length is one parameter that can be used to optimize a separation. Longer columns give better separation efficiency at the cost of time. Shorter columns can be used for faster separations with lower resolution. Depending on the complexity or number of analytes in the sample, a shorter column may be sufficient for a good separation.

Column Diameter

Column diameter can also be used to optimize a separation. Columns with a smaller diameter (inner diameter, or ID) should be chosen when sample amounts are limited. Since detection methods are sensitive to sample concentration, the amount of mobile phase needs to be reduced if a smaller amount of sample will be analyzed. Employing a smaller diameter column will give a stronger detector signal with limited sample amounts. Columns with a larger diameter are used to increase sample capacity or when more product yield is needed.

Particle Size

Smaller particles provide more efficient separations with sharper peaks but result in higher backpressure. Complex mixtures with many similar components should be separated with a high efficiency column with 5 µm particles or smaller. Simpler mixtures of structurally different sample components can be separated on columns with 7 µm or 10 µm or larger particles.

Column Accessories

In addition to chromatography columns, Hamilton also offers guard columns, bulk resin, and column hardware.

Why Use a Guard Column



Guard columns can provide many benefits when used upstream from an analytical, preparative, or semi-preparative column. Guard columns are typically

chosen to have the same packing as the primary column. Any compounds or particulate material that would block the frits or highly adsorb to the primary column will do so on the guard column, thereby protecting and extending the lifetime of the more costly column. In addition to protective uses, guard columns can be used as sacrificial preparative components.

With some applications, guard columns can be used instead of solid-phase extraction or other matrix-removing preparative steps. In many cases, this can reduce the preparative cost per sample. The use of a guard column will protect the investment of an analytical, preparative, or semi-preparative column.

Bulk Resin

Hamilton chromatography resins can be ordered in bulk, i.e. not packed into column hardware. This is a low cost approach to application-specific testing and analyses. Bulk resin can also be



purchased to pack your own columns. For information about ordering bulk resin, see the desired resin in the product section of this guide ("How to Choose Column Specifications" on page 12).

Column Hardware



Stainless steel or PEEK column hardware can be custom ordered without resin packing. For pricing and ordering information please contact HPLC@HamiltonCompany.com.

Custom Columns

Can't find the exact product you're looking for? Hamilton also offers the ability to design and purchase custom chromatography columns. Choose the material and dimensions of your column hardware and choose your column resin. For pricing and ordering information, call or email us, or visit our website.





Reversed-Phase Chromatography Columns

Hamilton reversed-phase HPLC columns are extremely durable and long-lasting. Hamilton offers four polymeric packing materials and two functionalized silica packing materials for reversed-phase separations. The different properties and functionalities of these six packing materials provide a broad range of possible separations. Each resin is also available as a guard column or as bulk resin.





Polymer-Based Resins

Hamilton polymeric resins provide selectivity different from traditional silica columns with the added benefits of higher tolerances for extreme pH and temperature than traditional silica columns.



Polymer-Based Resins

P. 16

Silica-Based Resins

Retention in reversed-phase silica columns tends to increase with lipophilicity. C18 functionalization retains hydrophobic compounds longer than C8. Hamilton offers two types of silica-based columns, C18 and C8 functionalization.



Silica-Based Resins

P. 22





Polymer-Based Resins

In the early stages of reversed-phase chromatography, columns were typically packed with a silica bead functionalized with a C18 chain. These columns were revolutionary for their time but are being replaced by modern polymeric supports. Polymer supports provide an alternate selectivity to silica columns with the additional benefit of increased sample recovery. Hamilton offers four reversed-phase resins based on poly(styrene-divinylbenzene) (PS-DVB) with three different functionalizations

including octadecylation, uncoated PS-DVB, and pentafluorination, each beneficial for different analyses. Each resin has a characteristic pore size or range of pore sizes and comes in a variety of formats (i.e. columns, bulk resins, and guard cartridges) and column dimensions. Hamilton polymeric columns are stable over the full pH range and compatible with virtually any aqueous or organic mobile phase. Thermal stability is maintained well over 85 °C.

Resin	Composition	Structure	Uses	Page
PRP-C18	C18-functionalized PS-DVB		Organic compounds: small molecules (< 2,000 mw), pharmaceuticals, steroids, halides, vitamins, amino acid analysis, herbicides	P. 17
PRP-1	PS-DVB		Organic compounds: small molecule (< 2,000 mw), pharmaceuticals, steroids, nucleic acids, vitamins, herbicides	P. 18
PRP-3			Organic compounds: large molecules (> 2,000 mw), peptides, proteins, protein digests, protected and deprotected oligonucleotides, nucleic acids	P. 19
PRP-h5	Pentafluorinated PS-DVB		Organic compounds: macromolecules (> 2,000 mw), pharmaceuticals, protein digests, tryptic digests, proteomics	P. 21



PRP-C18

PRP-C18 columns have genuine pH and chemical stability. The stationary phase stands up to prolonged exposure to concentrations as high as 1 M NaOH and H₂SO₄, with no measurable decrease in performance. The support does not strip, bleed, or dissolve at any pH. It can therefore perform reliably and reproducibly throughout the extended life of the column, regardless of mobile phase conditions.

Pore Size: 100 Å

Material: C18-functionalized PS-DVB

Applications: Organic compounds: small molecules (< 2,000 mw), pharmaceuticals, steroids, halides, vitamins, amino acids, herbicides. High pH applications.

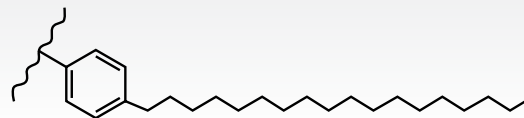

Stainless Steel Columns

ID	Length	Particle Size	P/N
2.1 mm	50 mm	5 µm	79672
	150 mm	5 µm	79673
	250 mm	5 µm	79674
4.6 mm	50 mm	5 µm	79675
	150 mm	5 µm	79676
	250 mm	5 µm	79677
21.2 mm	250 mm	12 – 20 µm	79678

Custom columns are available. Learn more by visiting our website.

PEEK Columns

ID	Length	Particle Size	P/N
2.1 mm	50 mm	5 µm	79679
	150 mm	5 µm	79680
	250 mm	5 µm	79681
4.6 mm	50 mm	5 µm	79682
	150 mm	5 µm	79683
	250 mm	5 µm	79684

Custom columns are available. Learn more by visiting our website.

Guard Cartridge Kits and Accessories

Size/Material	Description	P/N
Analytical / SS	Kit (1 Holder, 2 Cartridges)	79685
	Replacement Cartridges, 5/pack	79686
	Cartridge Holder	32908
Analytical / PEEK	Kit (1 Holder, 2 Cartridges)	79687
	Replacement Cartridges, 5/pack	79688
	Cartridge Holder	79477
Semiprep/Prep / SS	Kit (1 Holder, 1 Cartridge)	79689
	Replacement Cartridges, 2/pack	79690
	Cartridge Holder	5095-01

Guard Columns

ID	P/N
Analytical Guard Column	79291
Semiprep/Preparative Guard Column	79918

Custom columns are available. Learn more by visiting our website.

Bulk Resin

Particle Size	Quantity	P/N
5 µm	1 Gram	79791
10 µm	1 Gram	79792
12 – 20 µm	1 Gram	79793





PRP-1

PRP-1 columns have inherent reversed-phase separation qualities that eliminate the requirement for a stationary phase coating. Hydrolysis of the stationary phase coating is often the limiting factor in column lifetime, so the lack of coating on the PRP-1 resin extends the longevity of the column. PRP-1 also have exceptional sample recovery ($\geq 95\%$).

Pore Size: 100 Å

Material: PS-DVB

Applications: Organic compounds: small molecules (< 2,000 mw), pharmaceuticals, steroids, nucleic acids, vitamins, herbicides.

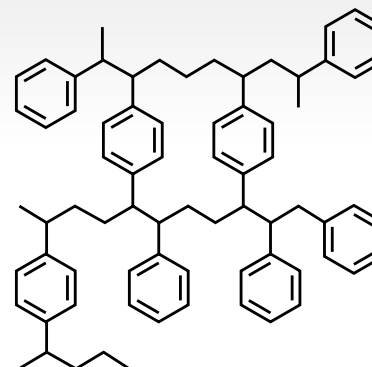

Stainless Steel Columns

ID	Length	Particle Size	P/N
1.0 mm	50 mm	5 μm	79751
	50 mm	7 μm	79755
	150 mm	5 μm	79753
2.1 mm	100 mm	5 μm	79790
	150 mm	5 μm	79366
4.1 mm	50 mm	5 μm	79443
	100 mm	5 μm	79479
	150 mm	5 μm	79444
	150 mm	7 μm	79529
	150 mm	10 μm	79425
	250 mm	5 μm	79820
	250 mm	7 μm	79422
7.0 mm	100 mm	10 μm	79427
	305 mm	10 μm	79495
	305 mm	5 μm	79795
10 mm	305 mm	10 μm	79426
	50 mm	7 μm	79367
	100 mm	5 μm	79355
	100 mm	10 μm	79499
	250 mm	7 μm	79531
21.2 mm	250 mm	10 μm	79496
	75 mm	5 μm	79154
	250 mm	7 μm	79352
	250 mm	10 μm	79478
30 mm	250 mm	12 – 20 μm	79428
	250 mm	12 – 20 μm	79229
50 mm	250 mm	10 μm	79567
	250 mm	12 – 20 μm	79493
101.6 mm	250 mm	12 – 20 μm	79525
101.6 mm, Repack	250 mm	12 – 20 μm	79800

Custom columns are available. Learn more by visiting our website.



PRP-1 (Cont.)

PEEK Columns

ID	Length	Particle Size	P/N
4.6 mm	100 mm	5 μm	79558
	150 mm	5 μm	79423
	150 mm	10 μm	79351
	250 mm	5 μm	79571
	250 mm	7 μm	79380
	250 mm	10 μm	79381

Custom columns are available. Learn more by visiting our website.

Guard Cartridge Kits and Accessories

Size/Material	Description	P/N
Analytical / SS	Kit (1 Holder, 2 Cartridges)	79447
	Replacement Cartridges, 5/pack	79445
	Cartridge Holder	32908
Analytical / PEEK	Kit (1 Holder, 2 Cartridges)	79317
	Replacement Cartridges, 5/pack	79318
	Cartridge Holder	79477
Semiprep/Prep / SS	Kit (1 Holder, 1 Cartridge)	79121
	Replacement Cartridges, 2/pack	79122
	Cartridge Holder	5095-01

Guard Columns

ID	P/N
Analytical Guard Column	79286
Semiprep/Preparative Guard Column	79912

Custom columns are available. Learn more by visiting our website.

Bulk Resin

Particle Size	Quantity	P/N
5 μm	1 Gram	79578
7 μm	1 Gram	79579
10 μm	1 Gram	79580
12 – 20 μm	1 Gram	79581
20 – 30 μm	1 Gram	79750
30 – 50 μm	1 Gram	79582
50 – 75 μm	1 Gram	79583

PRP-3

Hamilton PRP-3 columns are based off of the PRP-1 with a larger pore size for protein separation. This column resin has no silanol groups, so irreversible protein adsorption is not a concern, giving analytes such as proteins a recovery of > 90%. This stable material also allows the use of concentrated acids, chaotropes, and even detergents to minimize problems with protein solubility.

Pore Size: 300 Å

Material: PS-DVB

Applications: Organic compounds: large molecules (> 2,000 mw), peptides, proteins, protein digests, protected and deprotected oligonucleotides, nucleic acids.

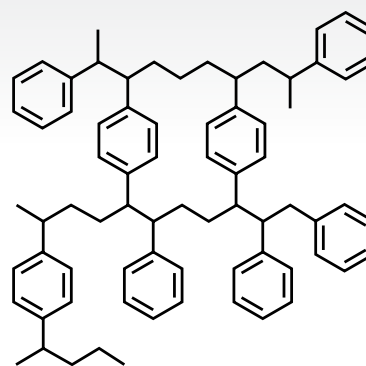



PRP-3 (Cont.)

Stainless Steel Columns

ID	Length	Particle Size	P/N
2.1 mm	150 mm	10 µm	79392
4.1 mm	150 mm	10 µm	79466
	250 mm	10 µm	79794
7.0 mm	305 mm	10 µm	79468
10 mm	250 mm	10 µm	79526
	100 mm	10 µm	79186
21.2 mm	250 mm	10 µm	79147
	250 mm	12 – 20 µm	79469

Custom columns are available. Learn more by visiting our website.

PEEK Columns

ID	Length	Particle Size	P/N
4.6 mm	150 mm	10 µm	79382
	250 mm	10 µm	79574

Custom columns are available. Learn more by visiting our website.

Guard Cartridge Kits and Accessories

Size/Material	Description	P/N
Analytical / SS	Kit (1 Holder, 2 Cartridges)	79461
	Replacement Cartridges, 5/pack	79454
	Cartridge Holder	32908
Analytical / PEEK	Kit (1 Holder, 2 Cartridges)	79393
	Replacement Cartridges, 5/pack	79395
	Cartridge Holder	79477
Semiprep/ Prep / SS	Kit (1 Holder, 1 Cartridge)	79123
	Replacement Cartridges, 2/pack	79124
	Cartridge Holder	5095-01

Guard Columns

ID	P/N
Analytical Guard Column	79295
Semiprep/Preparative Guard Column	79920

Custom columns are available. Learn more by visiting our website.

Bulk Resin

Particle Size	Quantity	P/N
10 µm	1 Gram	79701
12 – 20 µm	1 Gram	79702



PRP-h5

PRP-h5 is a PS-DVB base modified through pentafluorination of the benzene moiety. The fluorine functionalization provides a unique selectivity that can separate many analytes not resolved on traditional columns. This is especially true for halogenated compounds.

Pore Size: 300 Å

Material: Pentafluorinated PS-DVB

Applications: Organic compounds: large molecules (> 2,000 mw), halogenated compounds, pharmaceuticals, protein digests, tryptic digests, proteomics.

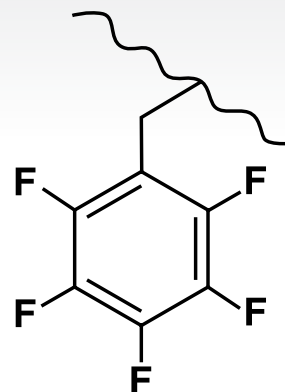

Stainless Steel Columns

ID	Length	Particle Size	P/N
2.1 mm	100 mm	5 µm	79270
	150 mm	5 µm	79271
	50 mm	5 µm	79261
4.6 mm	100 mm	5 µm	79262
	150 mm	5 µm	79272
	250 mm	5 µm	79273
10 mm	100 mm	5 µm	79263
	150 mm	5 µm	79274

Custom columns are available. Learn more by visiting our website.

Guard Columns

ID	P/N
Analytical Guard Column	79296
Semiprep/Preparative Guard Column	79921

Custom columns are available. Learn more by visiting our website.

Guard Cartridge Kits and Accessories

Size/Material	Description	P/N
Analytical / SS	Kit (1 Holder, 2 Cartridges)	79267
	Replacement Cartridges, 5/pack	79268
	Cartridge Holder	32908
Semiprep/ Prep / SS	Kit (1 Holder, 1 Cartridge)	79277
	Replacement Cartridges, 2/pack	79278
	Cartridge Holder	5095-01

Bulk Resin

Particle Size	Quantity	P/N
5 µm	1 Gram	79269
12 – 20 µm	1 Gram	79280



Silica-Based Resins

Alkylated silica is used for reversed-phase HPLC columns. Hamilton offers two varieties of this composition: C18 and C8. C18 columns are more hydrophobic than C8 columns and thereby retain hydrophobic analytes more strongly than a C8 column will. Due to stronger retention, C18 columns tend to result in longer retention times and better separations. C8 columns result in shorter analyte retention times which produce faster analysis times.

Resin	Composition	Structure	Uses	Page
HxSil C8	C8-functionalized silica		Polycyclic aromatic hydrocarbons, small organic molecules	P. 23
HxSil C18	C18-functionalized silica			



HxSil C8 and HxSil C18

Pore Size: 110 Å

Material: C8- and C18-functionalized silica

Applications: Polycyclic aromatic hydrocarbons, small organic molecules

Stainless Steel Columns

ID	Length	Particle Size	Packing	P/N
2.1 mm	33 mm	3 µm	C8	79116
	50 mm	3 µm	C8	79117
	50 mm	5 µm	C8	79107
	50 mm	3 µm	C18	79889
4.6 mm	100 mm	5 µm	C8	79109
	100 mm	5 µm	C8	79101
	150 mm	5 µm	C18	79868
	250 mm	5 µm	C18	79869

Custom columns are available. Learn more by visiting our website.

Guard Cartridge Kits and Accessories

Size/Material	Description	Packing	P/N
Analytical / SS	Kit (1 Holder, 2 Cartridges)	C8	79458
	Replacement Cartridges, 5/pack	C8	79451
	Kit (1 Holder, 2 Cartridges)	C18	79459
	Replacement Cartridges, 5/pack	C18	79452
Semiprep/ Prep / SS	Cartridge Holder	NA	32908
	Kit (1 Holder, 1 Cartridge)	C8	79135
	Replacement Cartridges, 2/pack	C8	79136
	Kit (1 Holder, 1 Cartridge)	C18	79137
	Replacement Cartridges, 2/pack	C18	79138
	Cartridge Holder	NA	5095-01

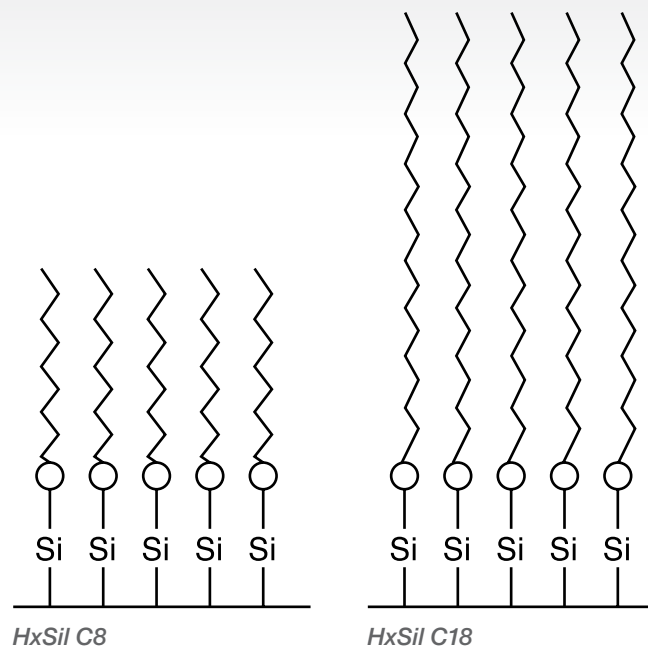

Guard Columns

ID	Packing	P/N
Analytical Guard Column	C8	79298
Semiprep/Preparative Guard Column	C8	79922
Analytical Guard Column	C18	79299
Semiprep/Preparative Guard Column	C18	79923

Custom columns are available. Learn more by visiting our website.

Bulk Resin

Particle Size	Quantity	Packing	P/N
3 µm	1 Gram	C8	79142
5 µm	1 Gram	C8	79143
10 µm	1 Gram	C8	79144
3 µm	1 Gram	C18	79139
5 µm	1 Gram	C18	79140
10 µm	1 Gram	C18	79141



Ion Chromatography Columns

Hamilton offers HPLC columns for three types of ion chromatography (IC): anion exchange, cation exchange, and ion exclusion. IC resins are used for the separation of polar and ionizable molecules.

Hamilton columns are compatible with virtually all HPLC systems and ion chromatographs. For guidance on which type of IC column is best for your application, please see the HPLC 101 section (page 10).





Anion Exchange

Hamilton offers seven positively charged resins for the separation of negatively charged molecules. Each resin has unique properties for different types of ions.



Anion Exchange

P. 26

Cation Exchange

Cation exchange columns are negatively charged for separation of positively charged molecules. Hamilton offers seven cation types of exchange columns for many different applications.



Cation Exchange

P. 34

Ion Exclusion

Hamilton's ion exclusion column separates ionic, weakly ionized, and nonionic compounds using a mixed-mode method.



Ion Exclusion

P. 39





Anion Exchange Columns

Anion exchange chromatography is used for the separation and analysis of ionic compounds. Such separations are significantly affected by the pH of the mobile phase. All of Hamilton's anion exchange columns are polymeric and allow the use of the full range of pH. This means that highly acidic or highly basic conditions can be employed

for improved separations without detriment to the column. Each resin is based on a cationic functionalization of poly(styrene-divinylbenzene) (PS-DVB). Different base cations, exchange strengths, and column dimensions can be chosen to fit a broad range of needs.

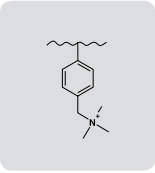
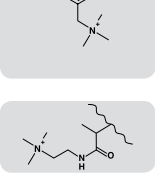
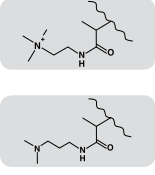
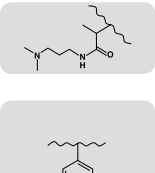
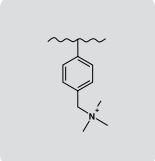
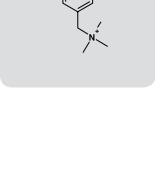
Resin	Composition	Structure	Uses	Page
PRP-X100	PS-DVB/Trimethyl ammonium exchanger		Organic and inorganic anions, organic acids, organic and inorganic arsenic species	P. 27
PRP-X110/S	PS-DVB/Trimethyl ammonium exchanger		Organic and inorganic anions, organic acids, organic and inorganic arsenic species	P. 27
PRP-X500	Methacrylamido propyl trimethyl ammonium chloride (SAX)		Peptides and proteins, nucleic acids: single stranded/double stranded RNA and DNA	P. 29
PRP-X600	Poly (dimethyl-amidopropylmethacrylamide) (WAX)		Peptides and proteins, nucleic acids: single stranded/double stranded RNA and DNA	P. 30
RCX-10	PS-DVB/Trimethyl ammonium exchanger		Carbohydrates, polysaccharides, sugar oligomers up to DP8	P. 31
RCX-30	PS-DVB/Trimethyl ammonium exchanger		Mono and disaccharides	P. 32



PRP-X100 and PRP-X110/S

Hamilton PRP-X100 and PRP-X110 are highly stable, inert materials. For high sensitivity, Hamilton PRP-X110 ion chromatography columns are used to separate ions at concentrations from less than 20 ppb to 20 ppm. The PRP-X110 has similar selectivity to the PRP-X100 but provides lower limits of separation as a result of its lower exchange capacity.

Pore Size: 100 Å

Exchange Capacity: PRP-X100 (0.19 meq/gm), PRP-X110 (0.11 meq/gm)

Material: PS-DVB/Trimethyl ammonium exchanger

Applications: Organic and inorganic anions, organic acids, organic and inorganic arsenic species, halides, nucleotides

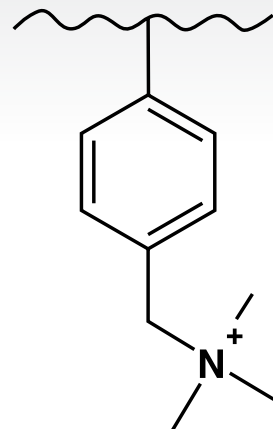

Stainless Steel Columns

ID	Length	Particle Size	Stationary Phase	P/N
2.1 mm	150 mm	10 µm	PRP-X100	79421
	250 mm	5 µm	PRP-X100	79190
	250 mm	10 µm	PRP-X100	79346
	50 mm	5 µm	PRP-X100	79810
	50 mm	10 µm	PRP-X100	79365
	100 mm	5 µm	PRP-X100	79538
	100 mm	10 µm	PRP-X100	79439
4.1 mm	150 mm	5 µm	PRP-X100	79812
	150 mm	10 µm	PRP-X100	79434
	150 mm	7 µm	PRP-X110	79732
	150 mm	7 µm	PRP-X110S	79733
	250 mm	7 µm	PRP-X110	79734
	250 mm	10 µm	PRP-X100	79433
	250 mm	7 µm	PRP-X110S	79735
21.2 mm	250 mm	12 – 20 µm	PRP-X100	79353

Custom columns are available. Learn more by visiting our website.

PRP-X110 versus PRP-X110S columns

PRP-X110 columns are equilibrated with a 2 mM p-hydroxybenzoic acid (pH 8.5) mobile phase and are ready for use with conductivity or indirect UV detection methods.

PRP-X110S columns are equilibrated with a 1.7 mM sodium bicarbonate, 1.8 mM sodium carbonate, 0.1 mM sodium thiocyanate mobile phase and are ready for use with suppressed conductivity detection methods.



PRP-X100 and PRP-110X/S (Cont.)

PEEK Columns

ID	Length	Particle Size	Stationary Phase	P/N
2.1 mm	100 mm	7 µm	PRP-X110S	79743
	150 mm	5 µm	PRP-X100	79852
	250 mm	5 µm	PRP-X100	79670
4.6 mm	100 mm	5 µm	PRP-X100	79669
	150 mm	5 µm	PRP-X100	79174
	150 mm	7 µm	PRP-X100	79665
	150 mm	10 µm	PRP-X100	79354
	150 mm	7 µm	PRP-X110	79738
	250 mm	5 µm	PRP-X100	79181
	250 mm	7 µm	PRP-X100	79668
	250 mm	7 µm	PRP-X110S	79671
	250 mm	7 µm	PRP-X110S	79741
	250 mm	10 µm	PRP-X100	79455

Custom columns are available. Learn more by visiting our website.

Guard Columns

ID	Stationary Phase	P/N
Analytical Guard Column	PRP-X100	79287
Analytical Guard Column	PRP-X110	79293
Semiprep/Preparative Guard Column	PRP-X100	79913

Custom columns are available. Learn more by visiting our website.

Guard Cartridge Kits and Accessories

Size/Material	Description	Stationary Phase	P/N
Analytical / SS	Kit (1 Holder, 2 Cartridges)	PRP-X100	79448
	Replacement Cartridges, 5/pack	PRP-X100	79446
	Kit (1 Holder, 2 Cartridges)	PRP-X110	79726
	Replacement Cartridges, 5/pack	PRP-X110	79728
	Cartridge Holder	NA	32908
Analytical / PEEK	Kit (1 Holder, 2 Cartridges)	PRP-X100	79383
	Replacement Cartridges, 5/pack	PRP-X100	79385
	Kit (1 Holder, 2 Cartridges)	PRP-X110	79727
	Replacement Cartridges, 5/pack	PRP-X110	79729
	Cartridge Holder	NA	79477
Semiprep/ Prep / SS	Kit (1 Holder, 1 Cartridge)	PRP-X100	79125
	Replacement Cartridges, 2/pack	PRP-X100	79126
	Cartridge Holder	PRP-X100	5095-01

Bulk Resin

Particle Size	Quantity	Stationary Phase	P/N
5 µm	1 Gram	PRP-X100	79584
7 µm	1 Gram	PRP-X110	79827
10 µm	1 Gram	PRP-X100	79585
12 – 20 µm	1 Gram	PRP-X100	79586



PRP-X500

PRP-X500 is a superficially porous polymeric anion exchange column. The methacrylate polymeric coating of the PRP-X500 provides a more hydrophilic surface, preventing hydrophobic interaction sample losses typically seen on other commercially available protein HPLC columns. Recovery of sample is excellent with PRP-X500 and the support's limited permeability prevents proteins from entering the pores and unfolding, which causes peak ghosting. The superficially porous properties of the packing material improves mass-transfer, shortening the diffusion path of the analyte. This results in shortened run times, improved resolution, and sharp sample bands.

Pore Size: Superficially porous

Exchange Capacity: 1.6 meq/gm

Material: Methacrylamido propyl trimethyl ammonium chloride (SAX)

Applications: Proteins, peptides, and DNA/RNA

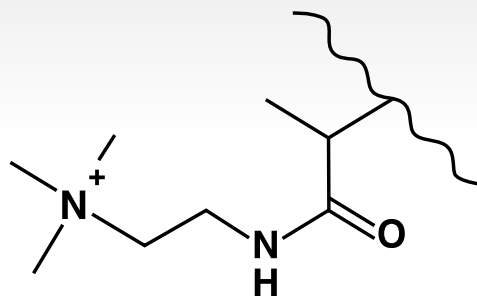

PEEK Columns

ID	Length	Particle Size	P/N
4.6 mm	50 mm	7 µm	79474
	150 mm	7 µm	79573

Custom columns are available. Learn more by visiting our website.

Guard Cartridge Kits and Accessories

Size/Material	Description	P/N
Analytical / PEEK	Kit (1 Holder, 2 Cartridges)	79319
	Replacement Cartridges, 5/pack	79320
	Cartridge Holder	79477
Semiprep/ Prep / SS	Kit (1 Holder, 1 Cartridge)	79866
	Replacement Cartridges, 2/pack	79865
	Cartridge Holder	5095-01

Guard Columns

ID	P/N
Semiprep/Preparative Guard Column	79919

Custom columns are available. Learn more by visiting our website.

Bulk Resin

Particle Size	Quantity	P/N
7 µm	1 Gram	79594
12 – 20 µm	1 Gram	79595
30 – 50 µm	1 Gram	79596



PRP-X600

PRP-X600 is a superficially porous support. Superficial porosity results in fast separation with better sample capacity and shortened diffusion path, resulting in sharper sample bands than non-porous supports. Rapid gradient changes typically lower column efficiency, however, PRP-X600 shows very favorable biomolecule separation efficiency with much shorter run times when rapid gradient changes are employed.

Pore Size: Superficially porous

Exchange Capacity: Adjustable by pH

Material:

Poly(dimethylamidopropylmethacrylamide) (WAX)

Applications: Nucleic acids such as single stranded/double stranded RNA and DNA, peptides, and proteins

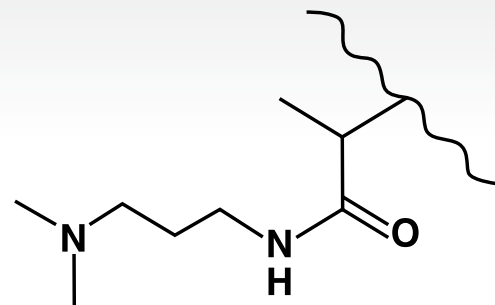
**PEEK Columns**

ID	Length	Particle Size	P/N
2.1 mm	150 mm	7 µm	79220
4.6 mm	50 mm	7 µm	79360
	250 mm	7 µm	79189

Custom columns are available. Learn more by visiting our website.

Guard Cartridge Kits and Accessories

Size/Material	Description	P/N
Analytical / PEEK	Kit (1 Holder, 2 Cartridges)	79361
	Replacement Cartridges, 5/pack	79362
	Cartridge Holder	79477

Bulk Resin

Particle Size	Quantity	P/N
7 µm	1 Gram	79597
12 – 20 µm	1 Gram	79598
30 – 50 µm	1 Gram	79599



RCX-10

Hamilton RCX-10 columns are designed with high exchange capacity for quality carbohydrate separation. Isocratic or gradient separations can be used depending on the complexity of the mixture. A pulsed amperometric detector (PAD) is recommended for gradient separations to utilize the full potential of this column. High pH can be used to enhance carbohydrate separation on RCX-10 and RCX-30 columns due to the negative charge of sugars at basic pH.

Pore Size: 100 Å

Exchange Capacity: 0.35 meq/gm

Material: PS-DVB/Trimethyl ammonium exchanger

Applications: Carbohydrates, polysaccharides, sugar oligomers up to DP8

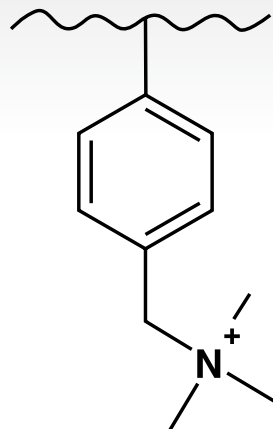

Stainless Steel Columns

ID	Length	Particle Size	P/N
4.1 mm	250 mm	7 µm	79440

Custom columns are available. Learn more by visiting our website.

PEEK Columns

ID	Length	Particle Size	P/N
4.6 mm	250 mm	7 µm	79388

Custom columns are available. Learn more by visiting our website.

Guard Cartridge Kits and Accessories

Size/Material	Description	P/N
Analytical / SS	Kit (1 Holder, 2 Cartridges)	79462
	Replacement Cartridges, 5/pack	79463
	Cartridge Holder	32908
Analytical / PEEK	Kit (1 Holder, 2 Cartridges)	79378
	Replacement Cartridges, 5/pack	79379
	Cartridge Holder	79477

Guard Columns

Description	P/N
Analytical Guard Column	79292

Custom columns are available. Learn more by visiting our website.

Bulk Resin

Particle Size	Quantity	P/N
7 µm	1 Gram	79703
12 – 20 µm	1 Gram	79704





RCX-30

Hamilton RCX-30 columns have further increased exchange capacity from RCX-10 columns. This results in longer retention and better separation of carbohydrate mixtures. High pH can be used to enhance carbohydrate separation on RCX-10 and RCX-30 columns due to the negative charge of sugars at basic pH.

Pore Size: 100 Å

Exchange Capacity: 1.0 meq/gm

Material: PS-DVB/Trimethyl ammonium exchanger

Applications: Complex mono- and disaccharide separation

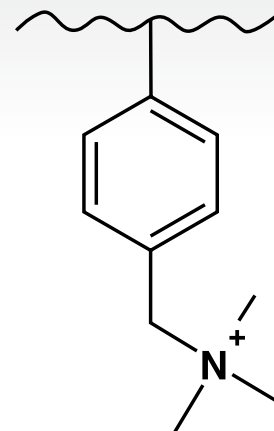

Stainless Steel Columns

ID	Length	Particle Size	P/N
4.1 mm	250 mm	7 µm	79803

Custom columns are available. Learn more by visiting our website.

PEEK Columns

ID	Length	Particle Size	P/N
4.6 mm	150 mm	7 µm	79370
	250 mm	7 µm	79877

Custom columns are available. Learn more by visiting our website.

Guard Cartridge Kits and Accessories

Size/Material	Description	P/N
Analytical / PEEK	Kit (1 Holder, 2 Cartridges)	79371
	Replacement Cartridges, 5/pack	79372
	Cartridge Holder	79477

Bulk Resin

Particle Size	Quantity	P/N
7 µm	1 Gram	79705
12 – 20 µm	1 Gram	79706





Specialty Anion Exchange Columns

Hamilton offers four anion exchange columns with resins and dimensions specifically designed to optimize particular aspects of anion separation.

Anion Resolution (P/N 79668)

This column is designed for enhanced anion resolution with high separation efficiency. It has high sample loading capacity and can be used to analyze low and high anion concentrations in the same run.

Anion Fast (P/N 79669)

This column is designed for fast separation of common anions (under 15 minutes). Sample concentrations should be between 1 and 500 ppm.

Anion Micro (P/N 79670)

This column is ideal for separating limited sample amounts with high resolution. It can be used with micropumps with $\mu\text{L}/\text{min}$ flow rates.

Anion Trace (P/N 79671)

This column results in improved signal-to-noise for very low anion concentrations (ppb). It also yields improved peak shape and retention times for late-eluting anions.





Cation Exchange Columns

Cation exchange chromatography is used for the separation and analysis of ionic compounds. Such separations are significantly affected by the pH of the mobile phase. All of Hamilton's cation exchange columns are polymeric and allow for the use of the full range of pH. This means that highly acidic or highly basic conditions can be

employed for improved separations without detriment to the column. Each resin is based on an anionic functionalization of poly (styrene-divinylbenzene) (PS-DVB). Different base anions, exchange strengths, and column dimensions can be chosen to fit a broad range of needs.

Resin	Composition	Structure	Uses	Page
PRP-X200	PS-DVB/Sulfonic acid exchanger		Inorganic and organic cations, alkali and alkaline earth metals, mono or divalent cations	P. 35
PRP-X400	PS-DVB/Sulfonic acid exchanger		Glyphosate and its metabolites in drinking water, inorganic and organic cations	P. 36
PRP-X800	PS-DVB/Itaconate exchanger (WCX)		Mono and divalent metals in the same run. Transition metals (e.g., manganese, zinc, cobalt and cadmium)	P. 37
HC-40 Ca ⁺²	PS-DVB/ Sulfonic acid exchanger		Mono-octasaccharides	P. 38
HC-75 Ca ⁺²	PS-DVB/ Sulfonic acid exchanger		Small sugars and sugar alcohols (mono-pentasaccharide)	P. 38
HC-75 H ⁺	PS-DVB/ Sulfonic acid exchanger		Acetylated sugars, carboxylated sugars, sugar alcohols	P. 38
HC-75 Pb ⁺²	PS-DVB/ Sulfonic acid exchanger		Mono- and disaccharides, and sugar alcohols	P. 38



PRP-X200

PRP-X200 columns can quickly resolve alkali metals, alkaline earth metals, and ammonium. One unique feature of this column is that the resolution between any two ions in the alkali metal series can be increased or decreased by changing the concentration of methanol in the mobile phase; allowing focus on the particular ion of interest and reducing interference from other ions in the sample.

Pore Size: 100 Å

Exchange Capacity: 35 µeq/gm

Material: PS-DVB/Sulfonic acid exchanger

Applications: Inorganic and organic cations, alkali and alkaline earth metals, mono or divalent cations

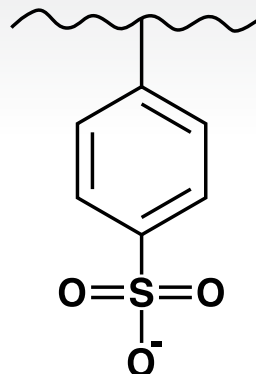

Stainless Steel Columns

ID	Length	Particle Size	P/N
2.1 mm	150 mm	10 µm	79394
	100 mm	10 µm	79363
4.1 mm	150 mm	10 µm	79441
	250 mm	10 µm	79442

Custom columns are available. Learn more by visiting our website.

PEEK Columns

ID	Length	Particle Size	P/N
4.6 mm	150 mm	10 µm	79384
	250 mm	10 µm	79357

Custom columns are available. Learn more by visiting our website.

Guard Cartridge Kits and Accessories

Size/Material	Description	P/N
Analytical / SS	Kit (1 Holder, 2 Cartridges)	79456
	Replacement Cartridges, 5/pack	79449
	Cartridge Holder	32908
Analytical / PEEK	Kit (1 Holder, 2 Cartridges)	79368
	Replacement Cartridges, 5/pack	79369
	Cartridge Holder	79477

Guard Columns

Description	P/N
Analytical Guard Column	79288
Semiprep/Preparative Guard Column	79914

Custom columns are available. Learn more by visiting our website.

Bulk Resin

Particle Size	Quantity	P/N
10 µm	1 Gram	79587
12 – 20 µm	1 Gram	79588



PRP-X400

The PRP-X400 column provides a fast separation for glyphosate and its metabolites, due in part to the higher exchange capacity of the resin. It also performs well in other separations, such as inositol and sugar alcohols. This column operates well at room temperature, so a column heater is not necessary for glyphosate separation. PRP-X400 columns are also very cost effective relative to most glyphosate columns.

Pore Size: 100 Å

Exchange Capacity: 2.5 meq/gm

Material: PS-DVB/Sulfonic acid exchanger

Applications: Glyphosate and its metabolites in drinking water, inorganic and organic cations

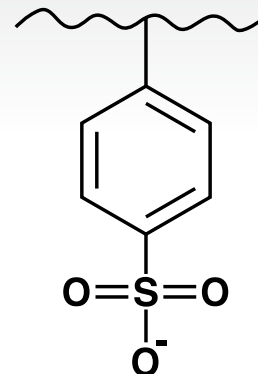

Stainless Steel Columns

ID	Length	Particle Size	P/N
2.1 mm	250 mm	7 µm	79398
4.1 mm	150 mm	7 µm	79717
	250 mm	7 µm	79473

Custom columns are available. Learn more by visiting our website.

PEEK Columns

ID	Length	Particle Size	P/N
4.6 mm	250 mm	10 µm	79387

Custom columns are available. Learn more by visiting our website.

Guard Cartridge Kits and Accessories

Size/Material	Description	P/N
Analytical / SS	Kit (1 Holder, 2 Cartridges)	79224
	Replacement Cartridges, 5/pack	79225
	Cartridge Holder	32908
Analytical / PEEK	Kit (1 Holder, 2 Cartridges)	79376
	Replacement Cartridges, 5/pack	79377
	Cartridge Holder	79477
Semiprep/ Prep / SS	Kit (1 Holder, 1 Cartridge)	79131
	Replacement Cartridges, 2/pack	79132
	Cartridge Holder	5095-01

Guard Columns

Description	P/N
Analytical Guard Column	79290
Semiprep/Preparative Guard Column	79916

Custom columns are available. Learn more by visiting our website.

Bulk Resin

Particle Size	Quantity	P/N
7 µm	1 Gram	79591
12 – 20 µm	1 Gram	79592
30 – 50 µm	1 Gram	79593



PRP-X800

The PRP-X800 is a polymeric cation exchange column functionalized with itaconic acid that performs the isocratic separation of mono- and divalent cations such as lithium, sodium, ammonium, potassium, magnesium, and calcium. The column offers excellent durability, is stable to any concentration organic solvent, and enables dynamic control of exchange capacity. Detection is via conductivity or indirect UV, depending on the mobile phase.

Pore Size: 100 Å

Exchange Capacity: 1.6 meq/gm

Material: PS-DVB/Itaconate exchanger (WCX)

Applications: Mono- and divalent metals, transition metals (e.g., manganese, zinc, cobalt, and cadmium)

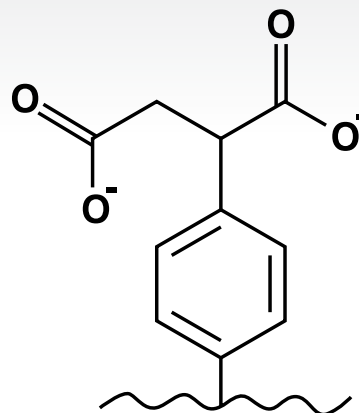

Stainless Steel Columns

ID	Length	Particle Size	P/N
4.1 mm	150 mm	7 µm	79855
	250 mm	7 µm	79828

Custom columns are available. Learn more by visiting our website.

Guard Cartridge Kits and Accessories

Size/Material	Description	P/N
Analytical / SS	Kit (1 Holder, 2 Cartridges)	79830
	Replacement Cartridges, 5/pack	79832
	Cartridge Holder	32908
Analytical / PEEK	Kit (1 Holder, 2 Cartridges)	79831
	Replacement Cartridges, 5/pack	79833
	Cartridge Holder	79477

Guard Columns

Description	P/N
Analytical Guard Column	79294

Custom columns are available. Learn more by visiting our website.



HC-40 and HC-75

HC-40 and HC-75 resins are soft gel column packings designed for oligosaccharide separations. The mobile phase of these columns is water without salts or buffer. This simplifies mobile phase preparation, reduces cost, and broadens the use of available detectors. Each of these columns has distinct retention characteristics and is designed for specific separations.

Pore Size: 100 Å

Exchange Capacity: 5 meq/gm

Material: PS-DVB/Sulfonic acid exchanger

Applications: Oligosaccharides
(degree of polymerization ≤ 8)

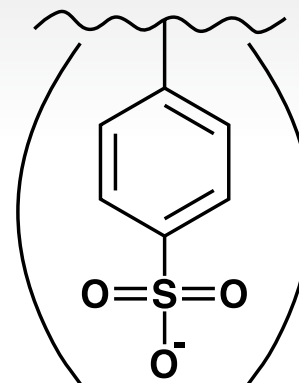

Ca⁺², 2H⁺, or Pb⁺²

Stainless Steel Columns

ID	Length	Form	P/N
4.1 mm	250 mm	HC-75 Ca ⁺²	79431
	250 mm	HC-75 H ⁺	79476
	100 mm	HC-75 H ⁺	79547
7.8 mm	100 mm	HC-75 Pb ⁺²	79240
	305 mm	HC-75 H ⁺	79544
	305 mm	HC-75 Ca ⁺²	79436
	305 mm	HC-75 Pb ⁺²	79438
	305 mm	HC-40 Ca ⁺²	79432

Custom columns are available. Learn more by visiting our website.

Guard Cartridge Kits and Accessories

Size/Material	Description	Stationary Phase	P/N
Semiprep/ Prep / SS	Kit (1 Holder, 1 Cartridge)	Carbonate	79866
	Replacement Cartridges, 2/pack	Carbonate	79865
	Kit (1 Holder, 1 Cartridge)	Hydrogen	79133
	Replacement Cartridges, 2/pack	Hydrogen	79134
	Cartridge Holder	NA	5095-01

Guard Columns

Description	Stationary Phase	P/N
Semiprep/Preparative Guard Column	Carbonate	79919
Semiprep/Preparative Guard Column	Hydrogen	79917

Custom columns are available. Learn more by visiting our website.

Bulk Resin

Particle Size	Quantity	Form	P/N
9 µm	1 Gram	HC-75 Ca ⁺²	79709
9 µm	1 Gram	HC-75 H ⁺	79711
9 µm	1 Gram	HC-75 Pb ⁺²	79712
9 µm	1 Gram	HC-40 Ca ⁺²	79707





Ion Exclusion Columns

Mixtures of weak organic acids, like those in fruits and milk products, are frequently not very well separated by pure ion exchange methods, nor in the reversed-phase mode. Hamilton offers

a polymeric packing material for ion exclusion separations which effectively separates these mixtures. For more information on this separation mechanism, see page 11.

PRP-X300

Hamilton PRP-X300 columns offer an easy, rapid way to separate closely related alcohols and organic acids. The sulfonated poly(styrene-divinylbenzene) support separates samples via a mixed mode mechanism. Separation on the PRP-X300 is accomplished by three modes: hydrogen bonding, reversed-phase, and ion exclusion. PRP-X300 column selectivity can be altered by changing the pH of the buffer or adding an organic modifier (e.g., methanol, acetonitrile). The support's stability to organic solvents makes it possible to analyze samples that are too highly retained on conventional ion exclusion supports.

The high performance packing ensures narrow peaks under isocratic conditions. The use of isocratic conditions allows samples to be analyzed one after another without waiting for column re-equilibration. Most samples require only minimal preparation before injection, increasing sample throughput in the lab.

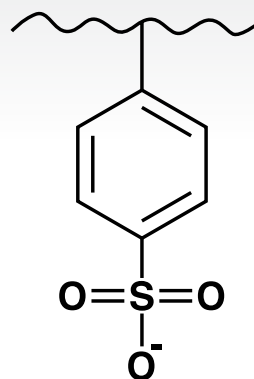

Pore Size: 100 Å

Material: PS-DVB/ Sulfonic acid

Applications: Organic acids and alcohols





PRP-X300 (Cont.)

Stainless Steel Columns

ID	Length	Particle Size	P/N
2.1 mm	250 mm	7 µm	79397
4.1 mm	150 mm	7 µm	79464
	250 mm	7 µm	79465

Custom columns are available. Learn more by visiting our website.

PEEK Columns

ID	Length	Particle Size	P/N
4.6 mm	150 mm	7 µm	79475

Custom columns are available. Learn more by visiting our website.

Guard Columns

Description	P/N
Analytical Guard Column	79289
Semiprep/Preparative Guard Column	79915

Custom columns are available. Learn more by visiting our website.

Bulk Resin

Particle Size	Quantity	P/N
7 µm	1 Gram	79589
12 – 20 µm	1 Gram	79590

Guard Cartridge Kits and Accessories

Size/Material	Description	P/N
Analytical / SS	Kit (1 Holder, 2 Cartridges)	79460
	Replacement Cartridges, 5/pack	79453
	Cartridge Holder	32908
Analytical / PEEK	Kit (1 Holder, 2 Cartridges)	79373
	Replacement Cartridges, 5/pack	79374
	Cartridge Holder	79477
Semiprep/ Prep / SS	Kit (1 Holder, 1 Cartridge)	79129
	Replacement Cartridges, 2/pack	79130
	Cartridge Holder	5095-01





HPLC Columns Technical Reference

This section includes information on the care and storage of Hamilton HPLC columns, specifications on each column resin, and some common chromatography calculations. For more information on a specific part number or application, visit our website at HamiltonCompany.com/HPLC or contact a local Hamilton representative.

Care and Storage	Precautions in Column Care Cleaning and Restoration Storage	P. 42 P. 42 P. 43
Resin Specifications	Reversed-Phase Resins, Anion Exchange Resins Cation Exchange Resins, Ion Exclusion Resins	P. 44, P. 45, P. 45, P. 45
Useful Calculations		P. 46

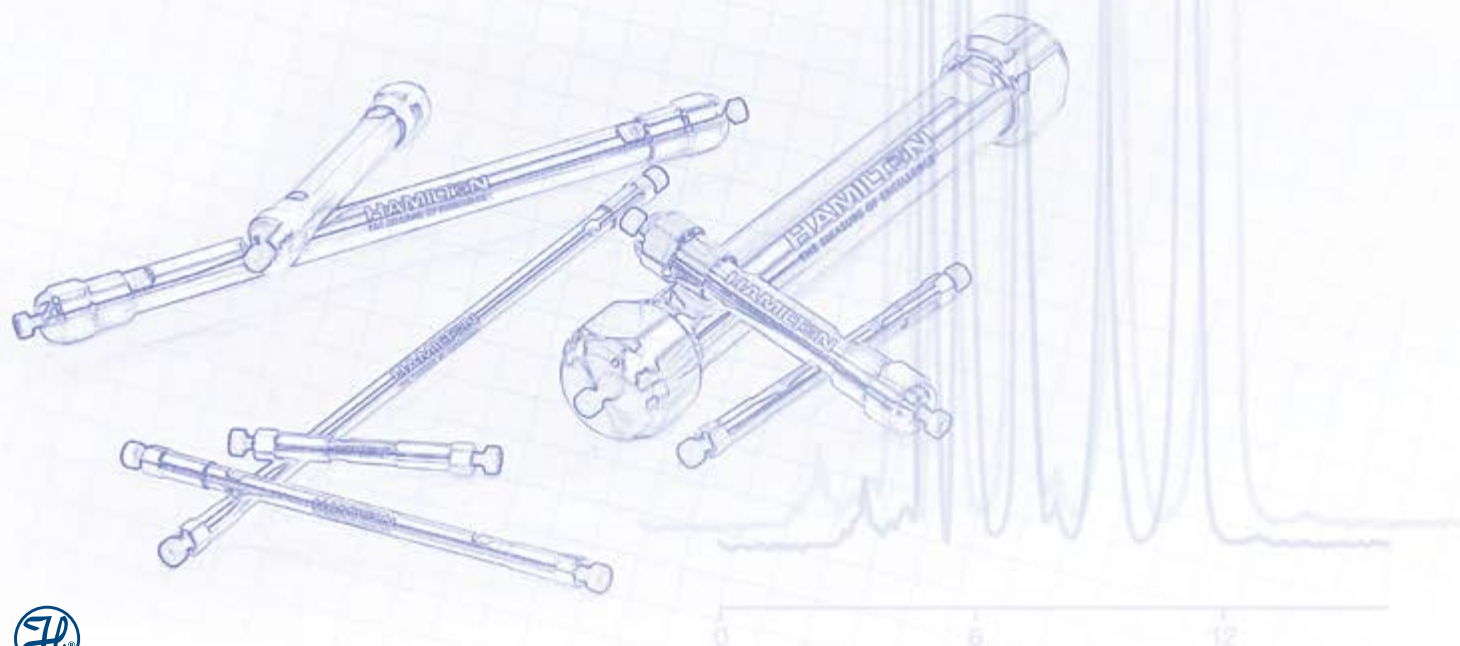



Care and Storage

Precautions in Column Care

- Routinely monitor the column's performance.
- Switch only between mutually miscible mobile phases.
- Avoid the possibility of precipitation of salts in the column.
- Use only filtered and degassed mobile phases.
- Do not allow the column to dry out.
- Keep the column capped with the end plugs that came with the column when not in use.
- Using guard columns is highly recommended to remove particulate matter or impurities which may permanently bind to the polymer packing materials inside the analytical column.

Cleaning and Restoration

Unusually high operating pressure is an indication of a plugged inlet frit. It may be cleared by reversing flow through the column for 5 – 10 column volumes.

Before using this method, reverse the flow of the column so that the mobile phase is entering what was the outlet. Do not connect the column to the detector. The previously noted precautions also apply to restoration. Be sure that the solvents are miscible and that salts will not precipitate.

Diminished column performance may be the result of column fouling or contamination. Column performance may be rejuvenated by following the column-specific procedure on the next page.



Cleaning and Restoration (Cont.)

Column Restoration Procedures

PRP-1, PRP-C18, PRP-3, PRP-h5, HxSil C8, HxSil C18	Flush with 40:40:20 (ACN:IPA:H ₂ O)
PRP-X100, PRP-X110/110S	Flush 50 mL of methanol with 1% 6 N nitric acid
PRP-X200, PRP-X300	Inject several times with 100 µL of 1 N nitric acid
PRP-X400	Inject several times with 100 µL of 0.1 M potassium EDTA
RCX-10	Flush with 50 mL of 0.1 N sodium hydroxide
RCX-30	Flush with 150 mL of 0.1 N sodium hydroxide
	Calcium Form Flush with 1% calcium chloride at 0.1 mL/min overnight
HC-75	Hydrogen Form Flush with 0.1 N sulfuric acid at 0.1 mL/min overnight
	Lead Form Flush with 1% lead nitrate at 0.1 mL/min overnight
HC-40	Calcium Form Flush with 1% calcium chloride at 0.1 mL/min overnight

Storage

For prolonged storage, use a storage solvent that will inhibit bacterial and mold growth such as 40% methanol and 60% water. If the mobile phase was buffer, flush all salts out before flushing with methanol/water storage solvent mixture.



Resin Specifications

Specifications of the available column resins can be found below, including polymeric-based (Poly(styrene-divinylbenzene), PS-DVB) and silica-based (HxSil) resins.

Reversed-Phase Resins

Polymer columns:

- Temperature limit: 5 – 85 °C
- Mobile phase limit: pH 1 – 13,
0 – 100% aqueous, organic modifier
- Buffer strength: 0.0 – 0.5 N

Silica columns:

- Temperature limit: 5 – 60 °C
- Mobile phase limit: pH 1.5 – 10,
0 – 100% aqueous, organic modifier

Packing Name	Support Material	Pore Size	Maximum Pressure
PRP-C18	C18 bonded to PS-DVB	100 Å	5,000 psi
PRP-1	PS-DVB	100 Å	5,000 psi
PRP-3	PS-DVB	300 Å	5,000 psi
PRP-h5	Fluorinated PS-DVB	300 Å	5,000 psi
HxSil C8	C8 bonded to silica	110 Å	6,000 psi
HxSil C18	C18 bonded to silica	110 Å	6,000 psi



Anion Exchange Resins

- Anion exchange columns have pH-dependent ranges of usable temperatures: pH 1 – 7.9 (5 – 60 °C), pH 8 – 13 (5 – 30 °C)
- Mobile phase can be pH 1 – 13, 0 – 100% organic modifier
- The maximum pressure is 5,000 psi

Packing Name	Support Material	Exchange Capacity	Pore Size	Maximum Pressure
PRP-X100	PS-DVB with Trimethyl ammonium Exchanger	0.19 meq/gm	100 Å	0.0 – 0.5 N
PRP-X110	PS-DVB with Trimethyl ammonium Exchanger	0.11 meq/gm	100 Å	0.0 – 0.5 N
PRP-X500	Poly(meth-acryl amido-propyl Trimethyl-ammonium chloride)	1.6 meq/gm	Superficially porous	0.0 – 2.0 N
PRP-X600	Poly(dimethyl amido-propyl meth-acrylamide)	1.6 meq/gm	Superficially porous	0.0 – 1.0 N
RCX-10	PS-DVB with Trimethyl ammonium Exchanger	0.35 meq/gm	100 Å	0.0 – 1.0 N
RCX-30	PS-DVB with Trimethyl ammonium Exchanger	1.0 meq/gm	100 Å	0.0 – 1.0 N

Cation Exchange Resins

Packing Name	Support Material	Exchange Capacity	Pore Size	Temp. Limits	Mobile Phase Limits	Buffer Strength	Maximum Pressure
PRP-X200	PS-DVB Sulfonate Exchanger	35 µeq/gm	100 Å	5 – 60 °C	pH 1 – 13, 0 – 100% aqueous, organic modifier	0.0 – 0.5 N	5,000 psi
PRP-X400	PS-DVB Sulfonate Exchanger	2.5 meq/gm	N/A	5 – 60 °C	pH 1 – 13, 0 – 100% aqueous, organic modifier	0.0 – 5.0 N	5,000 psi
PRP-X800	PS-DVB Itaconate Exchanger	1.6 meq/gm	100 Å	5 – 60 °C	pH 1 – 13, 0 – 100% aqueous, organic modifier	0.0 – 0.5 N	5,000 psi
HC-40 Calcium	PS-DVB Sulfonate Exchanger	5 meq/gm	Gel-type	25 – 90 °C	100% Water	Water	1,000 psi
HC-75 Calcium	PS-DVB Sulfonate Exchanger	5 meq/gm	Gel-type	25 – 90 °C	100% Water 0 – 40% Acetonitrile	Water	400 psi
HC-75 Hydrogen	PS-DVB Sulfonate Exchanger	5 meq/gm	Gel-type	25 – 90 °C	100% Water 0 – 40% Acetonitrile	0.0 – 0.05 N	400 psi
HC-75 Lead	PS-DVB Sulfonate Exchanger	5 meq/gm	Gel-type	25 – 90 °C	100% Water 0 – 40% Acetonitrile	Water	400 psi

Ion Exclusion Resins

Packing Name	Support Material	Exchange Capacity	Pore Size	Temp. Limits	Mobile Phase Limits	Buffer Strength	Maximum Pressure
PRP-X300	PS-DVB Sulfonate Exchanger	0.17 meq/gm	100 Å	5 – 60 °C	pH 1 – 13, 0 – 100% aqueous, organic modifier	0.0 – 0.5 N	5,000 psi





Useful Calculations

Retention Factor

Retention factor (k) relates the migration time of an analyte to the migration time of the mobile phase. Values between 2 and 10 are typically considered within the acceptable range. Values lower than this range elute too fast for accurate determination of retention time. Values larger than this range require very long run times.

$$k = \frac{(t_r - t_0)}{t_0},$$

where t_r is the retention time of the analyte (taken at the peak maximum) and t_0 is the column dead time.

Dead time can be measured experimentally or calculated with the following equation:

$$t_0 \approx \frac{(0.68\pi r^2 L)}{F},$$

where r is the column inner radius (ID/2), L is the column length, and F is the flow rate.

Selectivity

Relative selectivity of a column for specific analytes can be calculated using the retention factors of the individual analytes:

$$\alpha = \frac{k_b}{k_a},$$

where a is defined as eluting before b so that $\alpha > 1$.

Plate Count

The number of theoretical plates in a column is a way of describing column efficiency. The higher the number of plates, the more efficient a column is said to be. Theoretical plates can be calculated using the equation:

$$N = 16 \left(\frac{t_r}{w} \right)^2,$$

where w is the baseline peak width.



Tailing Factor

Tailing factor quantifies the degree to which a peak is asymmetric to the longer time range. It is calculated by:

$$T_F = \frac{W_{total}}{W_{front}},$$

where w_{total} is the width of the peak at 5% of the height, and w_{front} is the width of the front portion of the peak (when a perpendicular is drawn from the peak apex to the baseline) measured at 5% of the height.

Values less than 1.5 are typically not a concern.

Maximum Column Load

In order to determine the maximum volume of sample that should be injected, use the following equation:

$$\text{Maximum load (mL)} = 15\% \times \text{peak width (min)} \times \text{flowrate (mL/min)}$$

Resolution

Resolution is a quantity that takes into account both the separation of the peak maxima and the width of the individual peaks.

$$R = \frac{2[(t_R)_B - (t_R)_A]}{W_A + W_B}$$





INDEX

Index

5095-01	17, 19, 20, 21, 23, 28, 29, 36, 38, 40	79189	30	79319	29	79393.....	20
32908	17, 19, 20, 21, 23, 28, 31, 35, 36, 37, 40	79190	27	79320.....	29	79394.....	35
79101	23	79220.....	30	79346.....	27	79395.....	20
79107	23	79224.....	36	79351	19	79397.....	40
79109.....	23	79225.....	36	79352.....	18	79398.....	36
79116	23	79229.....	18	79353.....	27	79421.....	27
79117	23	79240.....	38	79354.....	28	79422.....	18
79121	19	79261	21	79355.....	18	79423.....	19
79122.....	19	79262.....	21	79357.....	35	79425.....	18
79123.....	20	79263.....	21	79360	30	79426.....	18
79124	20	79267	21	79361.....	30	79427.....	18
79125.....	28	79268.....	21	79362.....	30	79428.....	18
79126.....	28	79269.....	21	79363.....	35	79431.....	38
79129.....	40	79270.....	21	79365.....	27	79432.....	38
79130.....	40	79271	21	79366.....	18	79433.....	27
79131	36	79272.....	21	79367.....	18	79434.....	27
79132.....	36	79273.....	21	79368.....	35	79436.....	38
79133.....	38	79274	21	79369.....	35	79438.....	38
79134.....	38	79277.....	21	79370.....	32	79439.....	27
79135.....	23	79278.....	21	79371	32	79440.....	31
79136.....	23	79280.....	21	79372.....	32	79441	35
79137	23	79286.....	19	79373.....	40	79442.....	35
79138.....	23	79287	28	79374	40	79443.....	18
79139.....	23	79288.....	35	79376.....	36	79444.....	18
79140.....	23	79289.....	40	79377.....	36	79445.....	19
79141	23	79290.....	36	79378.....	31	79446.....	28
79142.....	23	79291.....	17	79379.....	31	79447	19
79143.....	23	79292.....	31	79380.....	19	79448.....	28
79144.....	23	79293.....	28	79381.....	19	79449.....	35
79147	20	79294.....	37	79382.....	20	79451	23
79154.....	18	79295.....	20	79383.....	28	79452.....	23
79174	28	79296.....	21	79384.....	35	79453.....	40
79181	28	79298.....	23	79385.....	28	79454.....	20
79186.....	20	79299.....	23	79387.....	36	79455.....	28
		79317	19	79388.....	31	79456.....	35
		79318.....	19	79392.....	20	79458.....	23





79459.....	23	79580.....	19	79683.....	17	79792.....	17
79460.....	40	79581.....	19	79684.....	17	79793.....	17
79461.....	20	79582.....	19	79685.....	17	79794.....	20
79462.....	31	79583.....	19	79686.....	17	79795.....	18
79463.....	31	79584.....	28	79687.....	17	79800.....	18
79464.....	40	79585.....	28	79688.....	17	79803.....	32
79465.....	40	79586.....	28	79689.....	17	79810.....	27
79466.....	20	79587.....	35	79690.....	17	79812.....	27
79468.....	20	79588.....	35	79701.....	20	79820.....	18
79469.....	20	79589.....	40	79702.....	20	79827.....	28
79473.....	36	79590.....	40	79703.....	31	79828.....	37
79474.....	29	79591.....	36	79704.....	31	79830.....	37
79475.....	40	79592.....	36	79705.....	32	79831.....	37
79476.....	38	79593.....	36	79706.....	32	79832.....	37
79477.....	17, 19, 20, 28, 29, 30, 31, 32, 35, 36, 37, 40	79594.....	29	79707.....	38	79833.....	37
79478.....	18	79595.....	29	79709.....	38	79852.....	28
79479.....	18	79596.....	29	79711.....	38	79855.....	37
79493.....	18	79597.....	30	79712.....	38	79865.....	29, 38
79495.....	18	79598.....	30	79717.....	36	79866.....	29, 38
79496.....	18	79599.....	30	79726.....	28	79868.....	23
79499.....	18	79665.....	28	79727.....	28	79869.....	23
79525.....	18	79668.....	28	79728.....	28	79877.....	32
79526.....	20	79669.....	28	79729.....	28	79889.....	23
79529.....	18	79670.....	28	79732.....	27	79912.....	19
79531.....	18	79671.....	28	79733.....	27	79913.....	28
79538.....	27	79672.....	17	79734.....	27	79914.....	35
79544.....	38	79673.....	17	79735.....	27	79915.....	40
79547.....	38	79674.....	17	79738.....	28	79916.....	36
79558.....	19	79675.....	17	79741.....	28	79917.....	38
79567.....	18	79676.....	17	79743.....	28	79918.....	17
79571.....	19	79677.....	17	79750.....	19	79919.....	29, 38
79573.....	29	79678.....	17	79751.....	18	79920.....	20
79574.....	20	79679.....	17	79753.....	18	79921.....	21
79578.....	19	79680.....	17	79755.....	18	79922.....	23
79579.....	19	79681.....	17	79790.....	18	79923.....	23
		79682.....	17	79791.....	17		



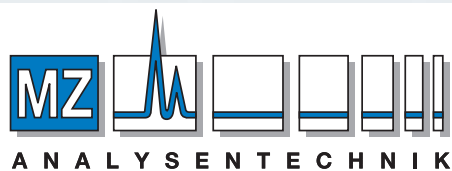

ANALYSENTECHNIK

AUTHORIZED DISTRIBUTOR

MZ-Analysentechnik GmbH, Barcelona-Allee 17 • D-55129 Mainz

Tel +49 6131 880 96-0, Fax +49 6131 880 96-20

e-mail: info@mz-at.de, www.mz-at.de

©2017 Hamilton Company. All rights reserved.

All other trademarks are owned and/or registered by Hamilton Company in the U.S. and/or other countries.

Lit. No. L80096 – 05/2017

HAMILTON 

Web: www.hamiltoncompany.com

USA: 800-648-5950

Europe: +40-356-635-050

Hamilton Americas & Pacific Rim

Hamilton Company Inc.
4970 Energy Way
Reno, Nevada 89502 USA
Tel: +1-775-858-3000
Fax: +1-775-856-7259
sales@hamiltoncompany.com

Hamilton Europe, Asia & Africa

Hamilton Central Europe S.R.L.
str. Hamilton no. 2-4
307210 Giarmata, Romania
Tel: +40-356-635-050
Fax: +40-356-635-060
contact.lab.ro@hamilton.ch

To find a representative in your area, please visit hamiltoncompany.com/contacts.