

chromatography *products*

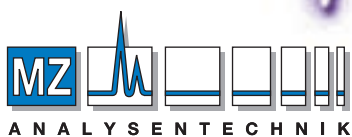
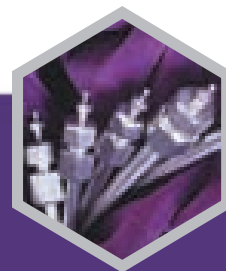

AUTHORIZED DISTRIBUTOR

MZ-Analysentechnik GmbH, Barcelona-Allee 17 • D-55129 Mainz

Tel +49 6131 880 96-0, Fax +49 6131 880 96-20

e-mail: info@mz-at.de, www.mz-at.de



TRANSGENOMIC®
BIOCONSUMABLES™



TRANSGENOMIC®
BIOCONSUMABLES™

Transgenomic is a global company focused on providing you the best separations technology with the highest reproducibility possible. We understand the quality of your results depends on us. Our entire team is dedicated to supporting you in your scientific quest.

The separations products we provide are based on our many years of experience in developing and manufacturing polymer chemistries for liquid chromatography. This vast experience and knowledge base continues to help us build on our strong tradition of providing the best products for your research and quality control needs.



Collin D'Silva

Collin D'Silva
Chief Executive Officer

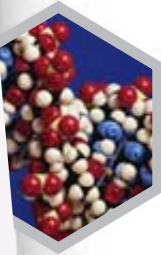

TABLE OF *Contents*

Application Guide	2
Amino Acid Analysis	3
Carbohydrate Analysis	7
Organic Acid Analysis	21
Polymeric Reversed Phase	32
Ion Chromatography	38
Guard-Disc® Protection System	42
Solid Phase Extraction	44
Bulk Polymeric Resin	46
Buffers	47
Hardware	48
Index	Inside backcover



APPLICATION SELECTION *Guide*

Amino Acids	Protein Hydrolysates	AMINOSep AA511 AMINOSep AA911 Na ⁺ Column for 63/7300 Systems Na ⁺ Column for System Gold
	Physiological Fluids	Li ⁺ Column for 63/7300
Carbohydrates	Monosaccharides Disaccharides Sugar Alcohols	CARBOSep CHO-620 CARBOSep CHO-682 CARBOSep CHO-820 CARBOSep CHO-611OH CARBOSep USP L-19 CARBOSep COREGEL-87C CARBOSep COREGEL-87P CARBOSep COREGEL-87H CARBOSep COREGEL-87MM
	Oligosaccharides, Corn Syrup,, Sugar Polymers	CARBOSep COREGEL-42Ag CARBOSep CHO411 CARBOSep CHO611 CARBOSep COREGEL-87K CARBOSep COREGEL-87N
Organic Acids	Sugar Alcohols Organic Acids	ICSep Ion-300 ICSep COREGEL-87H ICSep COREGEL-107H ICSep ORH-801 ICSep WA-1 Wine Analysis Column ICSep Ion-310 ICSep ARH-601 ICSep COREGEL 64H
Proteins/Peptides	Reversed Phase	RPSep ACT-1 C18 RPSep PRX-1 RPSep PolyRP C0
DNA, RNA, Oligonucleotides	Reversed Phase	RPSep PRX-1

AMINO ACID *Analysis*

Transgenomic Columns for Amino Acid Analysis

Ion-exchange chromatography is a popular technique for the analysis of amino acids because both retention times and quantification are highly reproducible regardless of the sample matrix. This unique matrix insensitivity is important when comparing results from different patients or batches of protein hydrolysate.

Amino acids are zwitterions; at low pH, they are positively-charged and are bound to the resin by their attraction to the negatively-charged ion-exchange sites. Almost all the contaminants, i.e. matrix, are eluted at the void. The amino acids are then selectively eluted by increasing the pH and salt concentration with different buffers. With few exceptions, the order of elution follows the isoelectric point of the amino acids, i.e. acidic amino acids first, then neutral and basic. Because the separation and the ensuing post-column reaction of amino acids are devoid of contaminants, amino acid analyses via ion-exchange chromatography are highly reproducible.



Features

The key features of the Transgenomic cation-exchange columns are:

- **Polymeric Substrate**
- **High efficiency**
- **High resolution**
- **Reproducibility lot-to-lot and column-to-column**
- **Rugged**
- **Available for both physiological and protein hydrolysate amino acids**

Amino acid columns are subjected to many different types of samples (blood, urine, growth media, animal feed, wine, etc.) and often they are introduced with minimum sample preparation. Therefore this variety of matrix challenges all but the most rugged ion-exchange columns. Transgenomic columns use polystyrene/divinylbenzene copolymers and are stable in the pH range of 0 to 14; they are temperature stable and very rugged. The Transgenomic amino acid columns have been shown to last for thousands of runs without cleaning. Because Transgenomic manufacture the polymers and pack the columns, lot-to-lot and column-to-column reproducibility is excellent (retention times vary by less than 1%). Available for both routine hydrolysate analysis as well as complex physiological fluids, Transgenomic amino acid columns have been designed to provide the highest efficiency and highest resolution of any ion-exchange amino acid columns on the market.



Oxidized Hydrolysate Standards

Analysis Conditions:

Column: Transgenomic Sodium Column for 6300
 Flow rate: 0.233 mL/min
 Temperature: 48-70-77°C
 Pressure: 655 PSIG
 Detection: Fluorescence
 Injection: 20 µL

Sample:

1. L-Cysteic Acid
2. Methionine Sulfoxide
3. L-Aspartic Acid
4. Methionine Sulfone

5. L-Threonine
6. L-Serine
7. L-Glutamic Acid
8. Glycine
9. L-Alanine
10. L-Valine
11. L-Methionine
12. L-Isoleucine
13. L-Leucine
14. Norfufine
15. L-Tyrosine
16. L-Phenylalanine
17. Glucosamine
18. Galactosamine
19. L-Histidine
20. L-Lysine
21. Tryptophan
22. Ammonia
23. L-Arginine

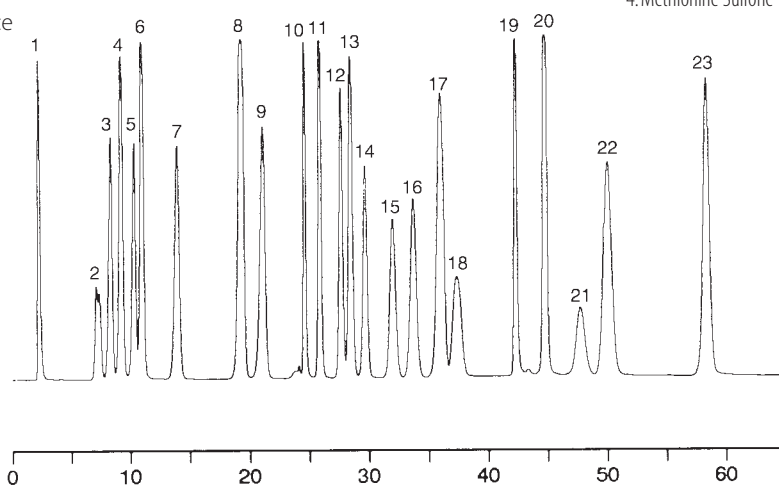

Physiological Fluid Amino Acids

Analysis Conditions:

Column: Transgenomic Lithium Column for 6300
 Flow rate: 0.333 mL/min
 Temperature: 32.5-63-80°C
 Pressure: 1200 PSIG
 Detection: UV
 Injection: 20 µL

Sample:

1. Phosphoserine
2. Taurine
3. Phosphoethanolamine
4. Urea
5. Glucosaminic Acid
6. Aspartic Acid
7. Hydroxyproline
8. Threonine
9. Serine
10. Asparagine
11. Glutamic Acid
12. Glutamine
13. Sarcosine
14. α -Amino adipic Acid
15. Proline
16. Glycine
17. Alanine
18. Citrulline
19. α -Amino- η -Butyric Acid

20. Valine
21. Cystine
22. Methionine
23. Cystathionine
24. Isoleucine
25. Leucine
26. Tyrosine
27. Phenylalanine
28. β -Alanine
29. β -Aminoisobutyric Acid
30. Homocystine
31. γ -Aminobutyric Acid
32. Ethanolamine
33. Ammonia
34. Hydroxylysine
35. allo-Hydroxylysine
36. Aminoethylcysteine
37. Ornithine
38. Tryptophan
39. Lysine
40. 1-Methylhistidine
41. Histidine
42. 3-Methylhistidine
43. Anserine
44. Carnosine
45. Arginine

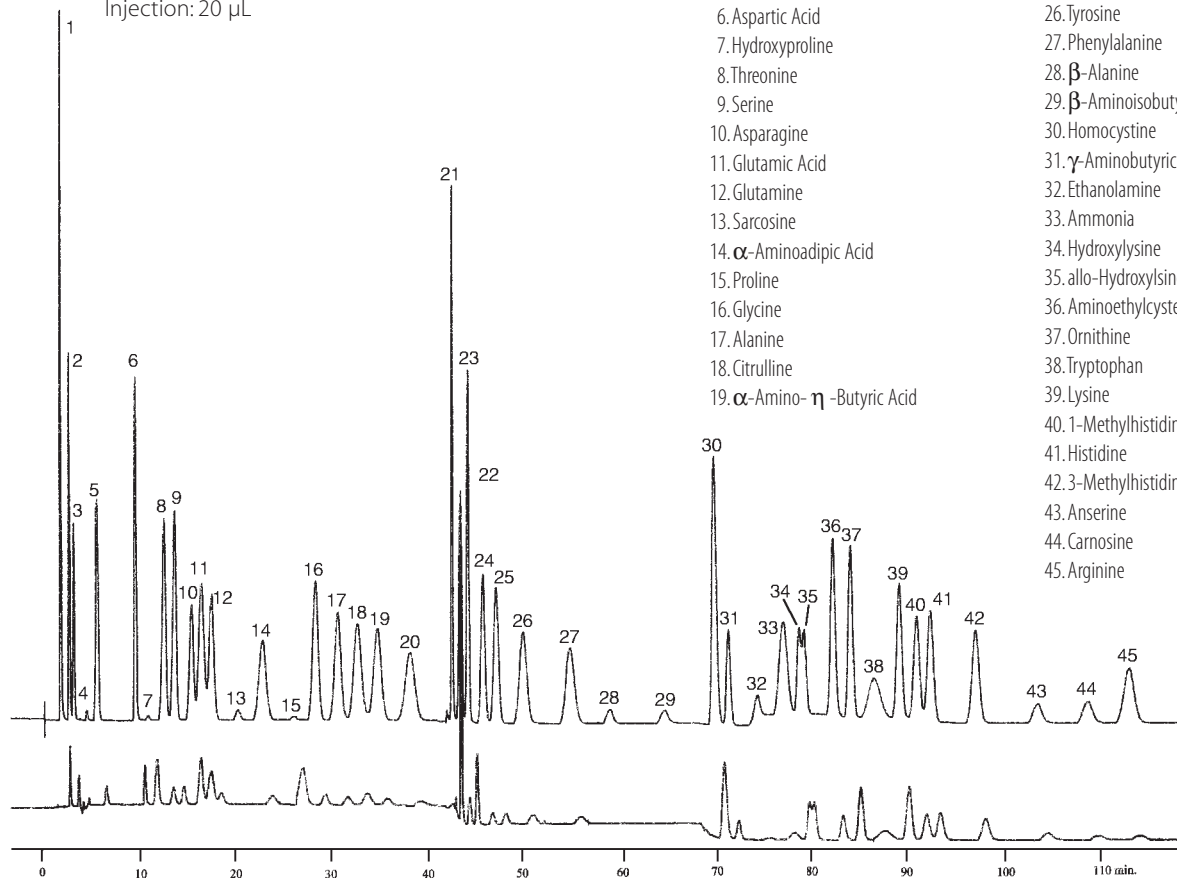

Amino Acid in Red Wine

Analysis Conditions:

Column: Transgenomic Sodium Column for 6300
 Flow rate: 0.233 mL/min
 Temperature: 48-70-77°C
 Pressure: 575 PSIG
 Detection: Fluorescence
 Injection: 20 µL

Sample:

- 1. Cysteic Acid
- 2. ASP
- 3. MTO2
- 4. THR
- 5. GLU
- 6. GLY
- 7. ALA
- 8. MET
- 9. Glucosamine
- 10. Galactosamine
- 11. HIS
- 13. LYS
- 14. NH3
- 15. ARG

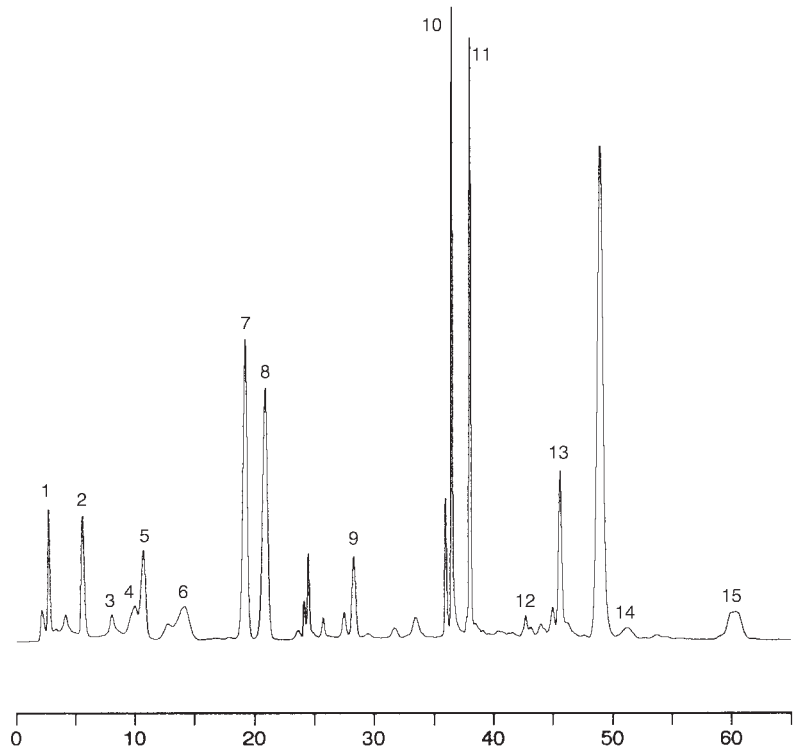

Amino Acid in Urine

Analysis Conditions:

Column: Transgenomic Lithium Column for 6300
 Flow rate: 0.333 mL/min
 Temperature: 32.5-63-80°C
 Pressure: 1200 PSIG
 Detection: Fluorescence
 Injection: 20 µL

Sample:

- 1. PER
- 2. TAU
- 3. PETN
- 4. THR
- 5. GLU
- 6. GLY
- 7. ALA
- 8. Met
- 9. CYST
- 10. ILE
- 11. LEU
- 12. TYR
- 13. PHE
- 14. BALA
- 15. BABA
- 16. TRP
- 17. EIN
- 18. NH3
- 19. ORN
- 20. LYS
- 21. 1 ME-HIS
- 22. HIS
- 23. 3 ME-HIS
- 24. ANS
- 25. CARN
- 26. ARG

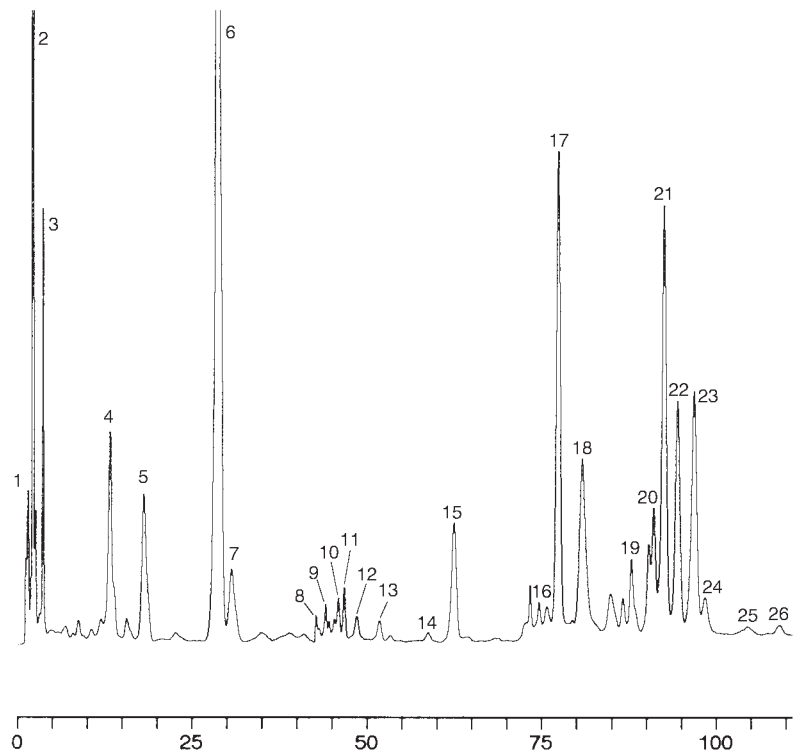

Transgenomic Lithium Amino Acid Column

(4 x 100 mm)

P/N AAA-99-6311

- Designed for use with the Beckman Coulter® 6300 and 7300 Amino Acid Analyzers using either the Beckman or Pickering Lithium buffer systems
- The Lithium column is ideal for Physiological amino acid analysis
- Highly efficient 6 micron particle size

AMINOSep Lithium Guard Kit

P/N AAA-99-2311

AMINOSep Lithium Guard Cartridge – 2/PK

P/N AAA-99-1311

Transgenomic Sodium Amino Acid Column

(4 x 120 mm)

P/N AAA-99-6312

- Designed for use with the Beckman Coulter 6300 and 7300 Amino Acid Analyzers using either the Beckman Coulter or Pickering Sodium buffer systems
- The Sodium column is ideally suited for routine hydrolysate analysis
- Extremely rugged polymer

AMINOSep Sodium Guard Kit

P/N AAA-99-2312

AMINOSep Sodium Guard Cartridge – 2/PK

P/N AAA-99-1312

Transgenomic Sodium Sodium Amino Acid Column for Use with System Gold

(4 x 200 mm)

P/N AAA-99-6310

- Designed for use with the Beckman Coulter System Gold Amino Acid Analyzer
- This Sodium cation exchange column is ideal for the separation of hydrolysate amino acids.

AMINOSep Sodium Guard Kit

P/N AAA-99-2312

AMINOSep Sodium Guard Cartridge – 2/PK

P/N AAA-99-1312

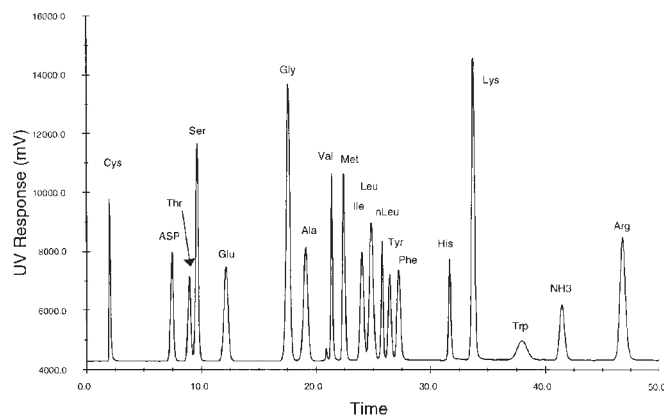
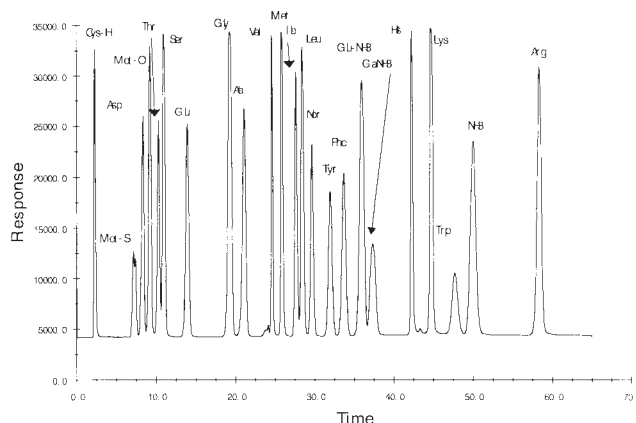
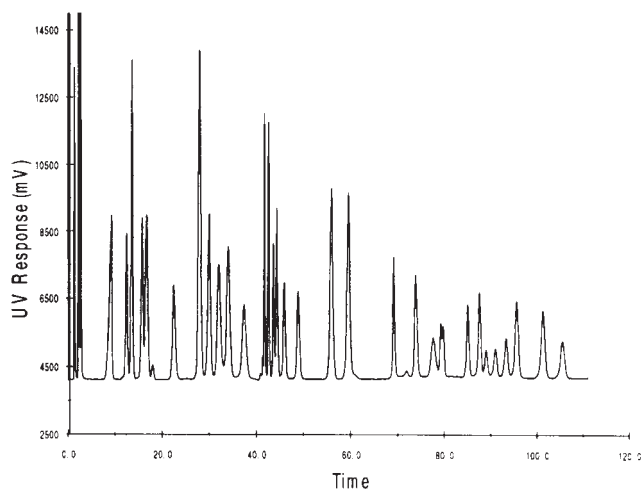

AMINOSep AA-911 Sodium Column

(4.6 x 250mm)
P/N AAA-99-8553

AMINOSep GC-911 Guard Kit

P/N AAA-99-2353

AMINOSep GC-911 Guard Cartridge

2 /PK P/N AAA-99-1353

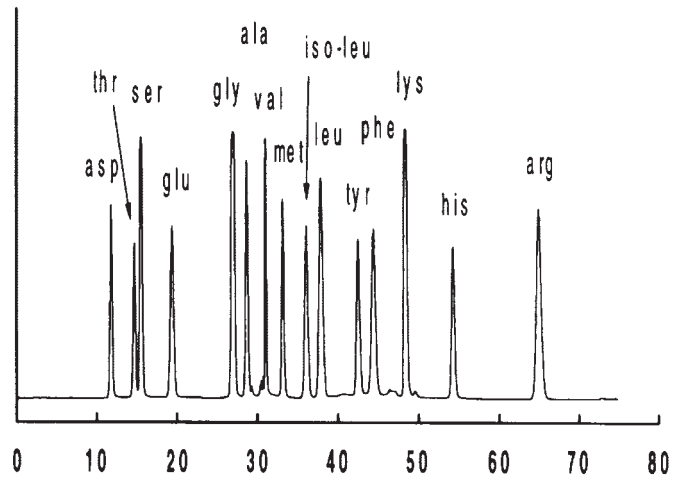

AMINOSep AA-511 Sodium Column

(4.6 x 150mm)
P/N AAA-99-7554

AMINOSep GC-511 Guard Kit

P/N AAA-99-2354

AMINOSep GC-511 Guard Cartridge – 2/PK

P/N AAA-99-1354

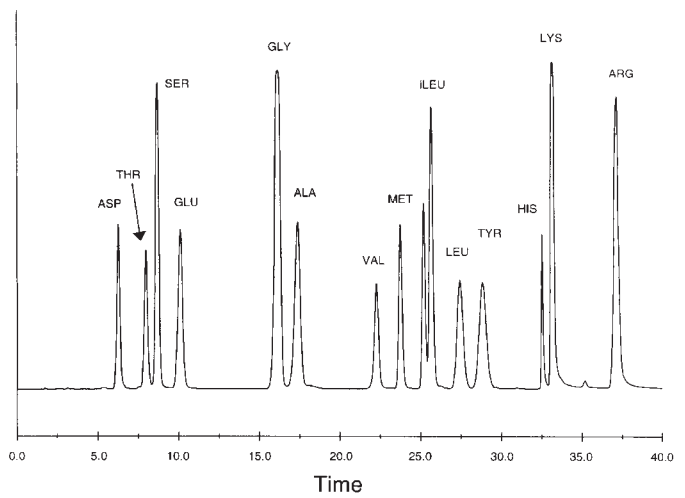

AMINOSep AA-511 High Speed Sodium Column

(4.6 x 120mm)
P/N AAA-99-6554

AMINOSep GC-511 Guard Kit

P/N AAA-99-2354

AMINOSep GC-511 Guard Cartridge – 2/PK

P/N AAA-99-1354

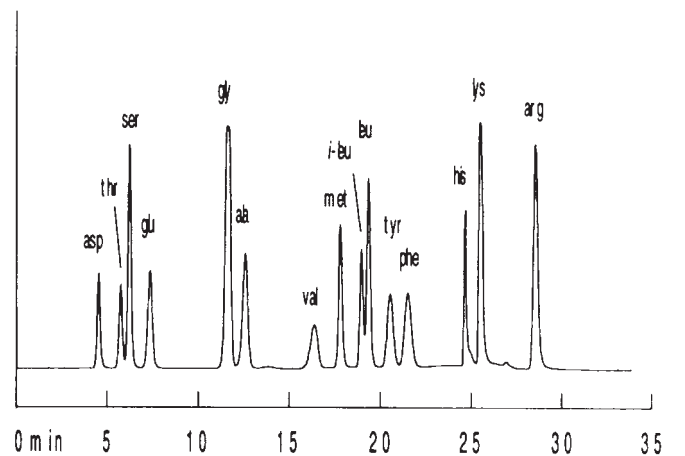

Analysis

CARBOSep Columns

Transgenomic manufactures a line of polymeric columns for carbohydrate analysis called CARBOSep columns. CARBOSep columns employ a technique called ligand-exchange chromatography for the separation of monosaccharides, disaccharides and oligosaccharides up to 15 glucose units long.

The principle behind ligand exchange is that each of the hydroxyls on a sugar molecule carry a very slight negative charge. The hydroxyl group on the anomeric carbon can be deprotonated and have a strong negative charge. It is the interaction between these negative charges on the sugar molecule and the positive charge contributed by the metal ion secured to the resin surface that causes the sugars to be retained and thus separated.

Ligand exchange resins are highly sulfonated cation exchange resins that have group 1, 2 or transition series metals loaded on. The sulfonic acid groups on the resin tightly hold the metal ions via an ionic attraction so that it is not released during analysis or through the life of the column. It is this metal ion that provides the positive charge that interacts with the negative charge on the sugar.

During analysis, the carbohydrates are introduced onto the column. The sugars are attracted to the metals via an ionic interaction thus they become weakly bound to the metal ion on the resin. Water will also have a weak ionic interaction with the metals on the column, so the water will exchange with the sugars on the metal sites. This ionic adsorption and desorption occurs for the sugars through the column. Since the ionic charge is different for every sugar, separation of the sugars occurs.

Selectivity is easily controlled by resin type, metal selected, and other factors such as temperature and mobile phase. CARBOSep columns are provided in a large variety of resin types and metals to provide selectivities that meet your separation needs.



Selectivity Chart for Carbohydrate Columns

Compound	CHO-620 (units in minutes)	CHO-611 (units in minutes)	CHO-682 (units in minutes)	COREGEL 87H (units in minutes)	COREGEL 87P (units in minutes)	COREGEL 87N (units in minutes)	COREGEL 87K (units in minutes)	COREGEL 87C (units in minutes)
Arabinose	10.64	11.08	23.95	12.08	16.32	12.64	14.72	13.92
Digitoxose	10.26	10.18	21.95	–	15.48	11.40	12.32	14.19
Fructose	10.07	10.33	25.84	11.25	16.96	11.61	13.31	13.63
Fucose	10.57	10.96	24.16	12.80	16.44	12.34	14.39	13.82
Galactose	9.58	10.22	22.32	11.12	15.16	11.44	13.36	13.82
Glucose	8.72	9.53	19.14	10.57	13.38	10.72	12.55	11.17
Mannose	9.79	10.27	25.50	11.13	16.76	11.57	13.74	12.76
Rhamnose	9.64	9.88	22.56	11.94	15.26	11.08	12.83	12.86
Sorbose	9.50	9.93	22.38	10.08	15.24	11.08	12.66	12.86
Tagatose	11.53	10.29	–	11.15	20.80	11.36	12.82	16.46
Xylose	9.56	10.34	20.64	11.32	14.42	11.77	13.69	12.32
Cellobiose	6.65	7.17	15.58	8.43	10.98	7.90	9.26	8.94
Lactose	7.01	7.51	17.37	8.77	11.84	8.18	9.63	9.44
Lactulose	7.57	7.85	20.70	9.00	13.24	8.48	10.08	10.17
Melibiose	6.99	7.46	17.63	8.56	12.02	8.19	9.72	9.36
Trehalose	6.70	7.14	15.98	8.64	11.20	7.85	9.02	9.07
Sucrose	6.76	7.27	15.70	–	11.10	7.99	9.11	9.09
Maltose	6.89	7.37	16.61	8.57	11.54	8.08	9.48	9.17
Ribitol	10.94	10.13	30.72	12.44	20.44	11.26	11.84	15.55
Arabitol	12.32	10.52	39.82	12.65	25.24	11.64	12.10	18.36
Galactitol	13.05	10.23	52.43	11.80	31.60	11.15	11.61	20.46
Myo-inositol	10.82	11.01	35.58	11.02	20.06	12.48	14.08	14.27
Lactitol	8.55	7.87	33.23	9.26	19.50	8.45	9.34	12.17
Maltitol	8.54	7.68	30.38	9.00	17.76	8.28	9.06	12.22
Mannitol	11.84	9.90	40.03	11.66	24.98	10.81	11.42	17.81
Sorbitol	13.64	10.38	56.56	11.77	33.40	11.32	11.86	21.34
Xylitol	13.93	11.01	51.15	12.82	31.10	12.16	12.64	21.30
Amiprylose	4.50	4.20	–	6.86	9.46	5.74	6.42	7.68
Melezitose	5.78	6.01	13.85	–	13.08	6.81	7.82	8.20
Maltotriose	5.91	6.22	15.17	7.72	10.54	6.98	8.16	8.28
Raffinose	5.86	6.10	14.40	–	10.22	6.88	7.92	8.24
Stachyose	5.28	5.39	13.41	–	9.58	6.33	7.28	7.77
Maltotetrose	5.37	5.54	14.07	7.30	9.84	6.42	7.46	7.80
Maltopentose	5.00	5.08	13.08	7.10	9.34	6.11	7.02	7.53
Maltohexose	4.78	4.87	12.24	7.00	8.80	5.94	6.74	7.38
Maltoheptose	4.66	4.60	11.74	6.96	8.52	5.84	6.61	7.28
Nitrate	4.50	4.20	10.30	6.85	8.40	5.70	6.40	7.30

• Mobile Phase: 100% water. • Flow rate: 0.5 mL/minute. • Temperature: 90°C

Carbohydrate Columns Specifications Chart

Column	Application	Form	Particle Size (µm)	Typical Mobile Phase	Recom'd Rate Flow (mL/min)	Recom'd Temp (°C)
CARBOsep CHO-411	oligosaccharides up to DP10, corn syrup, molasses	sodium	20	water	0.4	75
CARBOsep CHO-611	oligosaccharides up to DP5	sodium	10	water	0.5	90
CARBOsep CHO-6110H	mono and oligosaccharides w/ PAD detection	sodium	10	sodium hydroxide	0.5	90
CARBOsep CHO-620	high fructose corn syrup, mono-, di-, trisaccharides and sugar alcohols	calcium	10	water	0.5	90
CARBOsep CHO-682	mono and disaccharides, sucrose, maltose lactose	lead	7	water	0.4	80
CARBOsep CHO-820	simple sugars, sugar alcohols	calcium	8	water	0.5	90
CARBOsep COREGEL 87C	mono and disaccharides	calcium	9	water	0.6	85
ICSep COREGEL 87H1	fast analysis of organic acids, alcohols, sugar mixtures	hydrogen	9	sulfuric acid	0.6	85
ICSep COREGEL 87H3	organic acids, alcohols, sugar mixtures	hydrogen	9	sulfuric acid	0.6	85
CARBOsep COREGEL-42Ag	oligosaccharides up to DP11	silver	20	water	0.4	75
CARBOsep COREGEL 87K	beet sugar, cane sugar, corn syrup, molasses	potassium	8	water	0.6	85
CARBOsep COREGEL 87N	beet sugars, mono and oligosaccharides	sodium	8	water	0.6	85
CARBOsep COREGEL 87P	pentose, hexose, monosaccharides, alcohols	lead	8	water	0.8	85
CARBOsep USP L19	USP L-19 specifications for separation of sorbitol and mannitol	calcium	9	water	0.2	30
CARBOsep COREGEL-87MM	mono, di, and trisaccharides, and sugar alcohols	calcium/sodium	8	water	0.5	85
ICSep ION300	glucose and fructose in organic acid mixtures	hydrogen	8	sulfuric acid	0.4	70
ICSep ION310	grape must analysis	hydrogen	8	sulfuric acid	0.8	50

• Mobile Phase: 100% water. • Flow rate: 0.5 mL/minute. • Temperature: 90°C

Separation of Carbohydrates with PAD

Analysis Conditions:

Column: CHO-611OH
 Eluent: 0.015N NaOH
 Flow rate: 0.6 mL/min
 Temperature: 85°C
 Detection: PAD
 Injection: 5 µL

Sample:

- 1. Sucrose (500 ppm)
- 2. Glucose (250 ppm)
- 3. Arabinose (250 ppm)

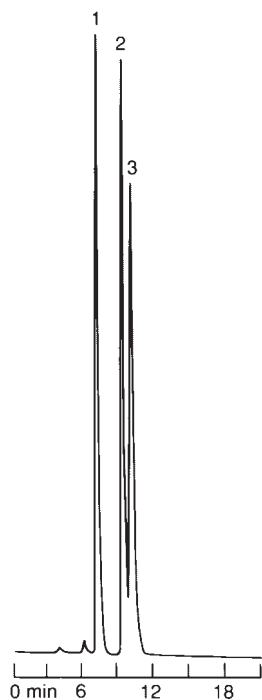

Separation of Carbohydrate Standards

Analysis Conditions:

Column: CHO-820
 Eluent: Distilled Water
 Flow rate: 0.5 mL/min
 Temperature: 90°C
 Detection: DRI

Sample:

- 1. Raffinose
- 2. Sucrose
- 3. Glucose
- 4. Galactose
- 5. Fructose
- 6. Mannitol
- 7. Sorbitol

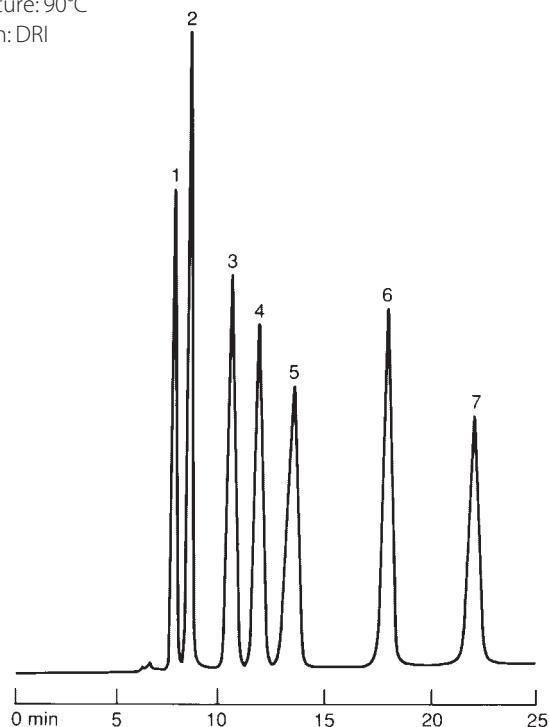

Separation of Blocked Carbohydrates

Analysis Conditions:

Column: CHO-611OH
 Eluent: 0.01 N NaOH
 Flow rate: 0.5 mL/min
 Temperature: 85°C
 Detection: RI
 Injection: 10 µL

Sample: 1 mg/ml each,

- 1. Monoacetone xylofuranose
- 2. Diacetone xylofuranose

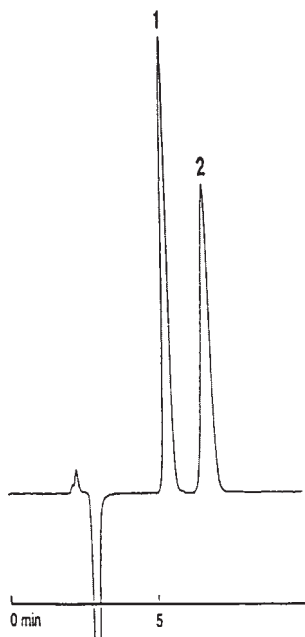

Separation of Mannitol and Sorbitol for USP-L-19

Analysis Conditions:

Column: CHO-820 L-19
 Eluent: Distilled Water
 Flow rate: 0.2 mL/min
 Temperature: 30°C
 Detection: RI

Sample:

- 1. Mannitol
- 2. Sorbitol

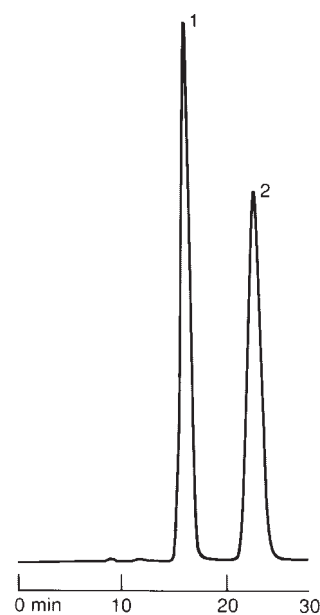

Separation of Sugars in Apple Juice

Analysis Conditions:

Column: CHO-820
(7.8 mm x 300)
Eluent: Distilled Water
Flow rate: 0.5 mL/min
Temperature: 90°C
Pressure: 50 Bar
Detection: RI Range 16x
Injection: 20 µL

Sample:

Apple Juice Diluted 1:9 with DI Water

1. Sucrose
2. Glucose
3. Fructose
4. Sorbitol

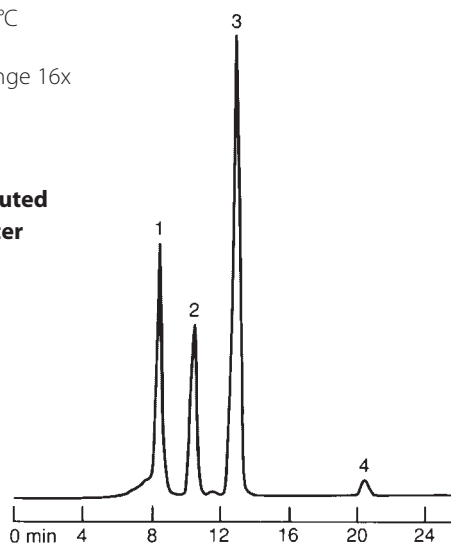

Apple Juice

Analysis Conditions:

Column: CHO-620
Eluent: H₂O
Flow rate: 0.5 mL/min
Temperature: 90°C
Detection: DRI
Injection: 20 µL

Sample:

1. Sucrose
2. Glucose
3. Fructose

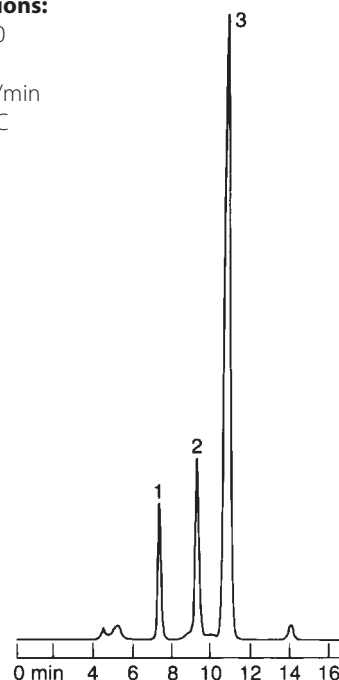

Separation of Various Sugars and Sugar Alcohols on a Coregel-87C Column

Analysis Conditions:

Column: Coregel-87C
(7.8 mm x 300)
Eluent: Distilled Water
Flow rate: 0.6 mL/min
Temperature: 85°C
Pressure: 425 psig
Detection: RI Range 18x
Injection: 20 µL

Sample:

1. Raffinose
2. Sucrose
3. Lactulose
4. Glucose
5. Galactose
6. Fructose
7. Ribitol
8. Mannitol
9. Sorbitol

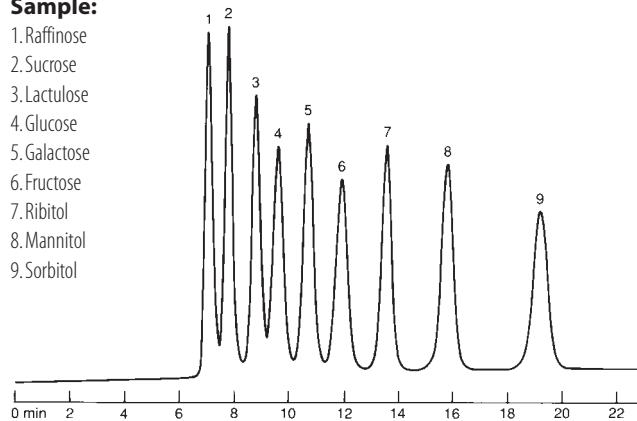

Analysis of Honey on a Coregel-87C Column

Analysis Conditions:

Column: Coregel-87C
Eluent: Distilled Water
Flow rate: 0.6 mL/min
Temperature: 85°C
Pressure: 425 psig
Detection: RI Range 16x
Injection: 20 µL

Sample:

1. DP3
2. DP2
3. Glucose
4. Fructose

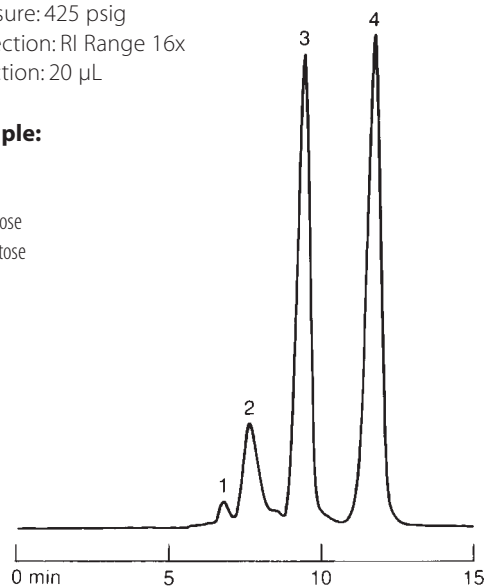

Sugar Separation on CARBOsep CHO-820

Analysis Conditions:

Column: CHO-820
 Eluent: Distilled Water
 Flow rate: 0.5 mL/min
 Temperature: 90°C
 Detection: RI
 Injection: 20mL

Sample:

- 1. Melezitose (2.4 mg/mL)
- 2. Maltose (2.4 mg/mL)
- 3. Glucose (2.4 mg/mL)
- 4. Maltitol (3.2 mg/mL)
- 5. Fucose (2.4 mg/mL)
- 6. Ribose (2.4 mg/mL)

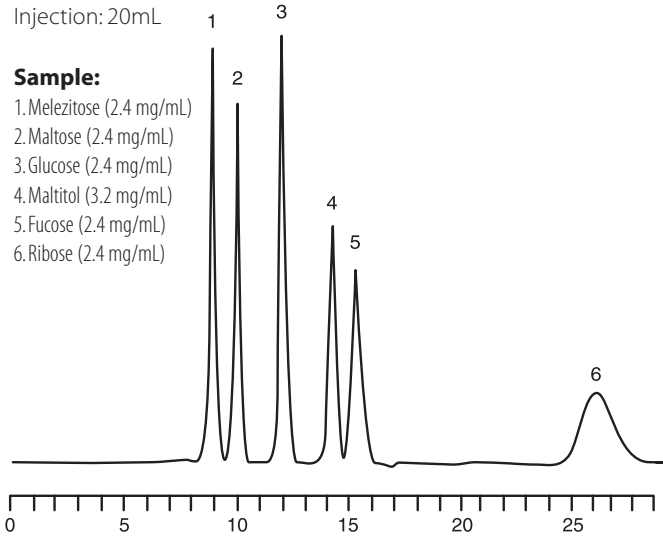

Corn Syrup

Analysis Conditions:

Column: CHO-411
 Eluent: H₂O
 Flow rate: 0.5 mL/min
 Temperature: 75°C
 Detection: DRI
 Injection: 20 µL of diluted dark corn syrup

Sample:

- 1. DP7
- 2. DP6
- 3. DP5
- 4. DP4
- 5. DP3
- 6. Maltose
- 7. Glucose

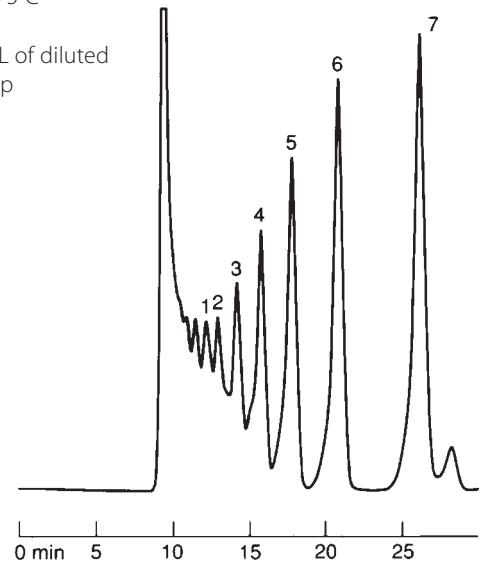

Orange Juice

Analysis Conditions:

Column: CHO-620
 Eluent: H₂O
 Flow rate: 0.5 mL/min
 Temperature: 90°C
 Detection: DRI
 Injection: 20 µL

Sample:

- 1. Oligosaccharides
- 2. Sucrose
- 3. Glucose
- 4. Fructose

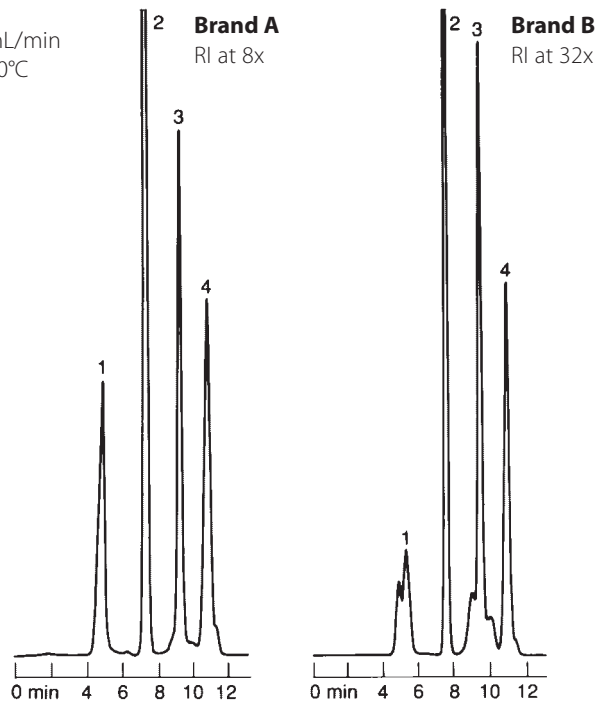

Domestic Beer

Analysis Conditions:

Column: CHO-682
 Eluent: H₂O
 Flow rate: 0.4 mL/min
 Temperature: 80°C
 Detection: DRI
 Injection: 20 µL

Sample:

1. Higher oligosaccharides
2. DP6
3. DP5
4. DP3
5. DP4
6. Maltose
7. Glucose
8. Ethanol

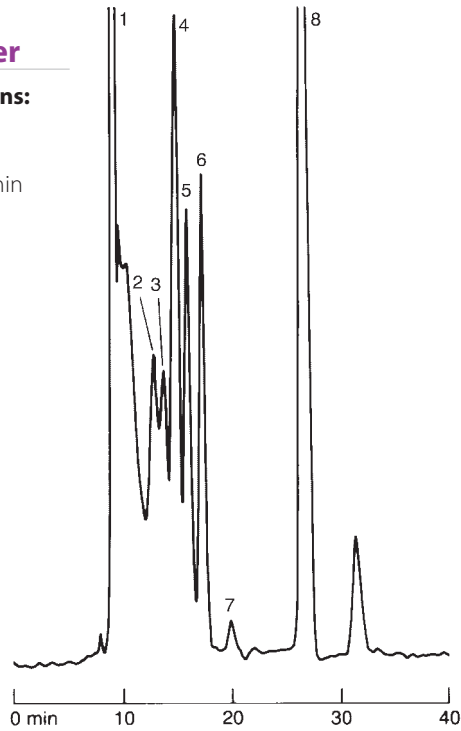

Determination of Sugars in Ale

Analysis Conditions:

Column: CHO-682
 Eluent: H₂O
 Flow rate: 0.4 mL/min
 Temperature: 80°C
 Detection: DRI
 Injection: 20 µL

Sample:

1. Maltose
2. Glucose
3. Ethanol

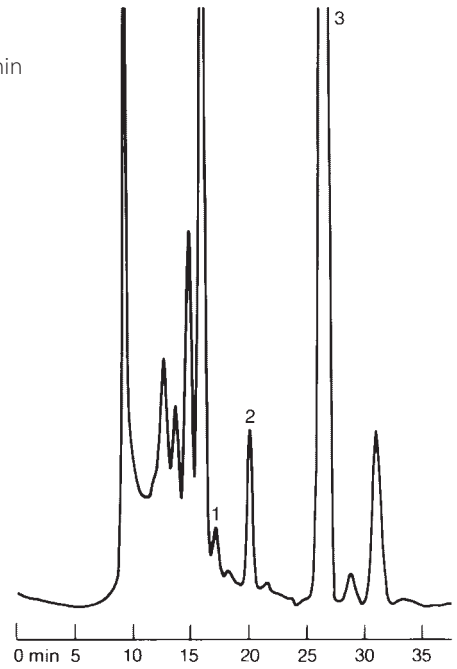

Non-alcoholic Malt Liquor

Analysis Conditions:

Column: CHO-411
 Eluent: H₂O
 Flow rate: 0.5 mL/min
 Temperature: 75°C
 Detection: DRI
 Injection: 20 µL

Sample:

1. DP6
2. DP5
3. DP4
4. DP3
5. Maltose
6. Glucose
7. Ethanol

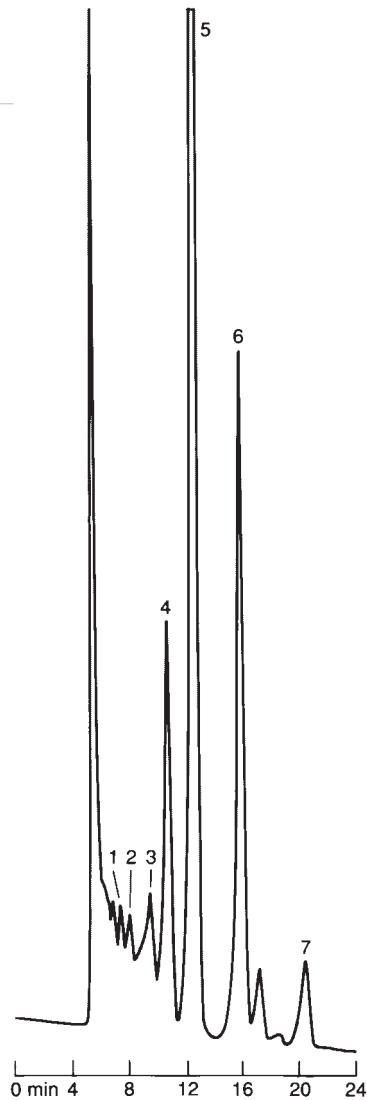

Malted Milk Candy

Analysis Conditions:

Column: CHO-411
 Eluent: H₂O
 Flow rate: 0.5 mL/min
 Temperature: 75°C
 Detection: DRI
 Injection: 20 µL of pretreated sample with POLYSorb™ ACT-1

Sample:

1. DP7
2. DP6
3. DP5
4. DP4
5. DP3
6. Maltose
7. Glucose

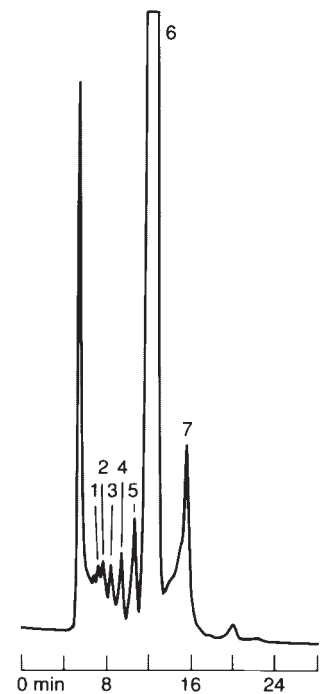

Mono- and Disaccharides

Analysis Conditions:

Column: CHO-682
 Eluent: H₂O
 Flow rate: 0.4 mL/min
 Temperature: 80°C
 Detection: Refractometry

Sample:

1. Sucrose
2. Maltose
3. Glucose
4. Xylose
5. Galactose
6. Arabinose
7. Mannose

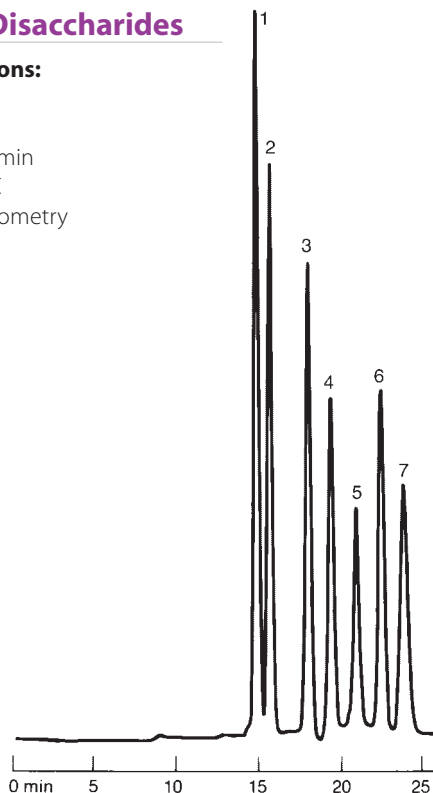

Standard Sugar Mixture On CHO-620 Column

Analysis Conditions:

Column: CHO-620
 Eluent: H₂O
 Flow rate: 0.5 mL/min
 Temperature: 90°C
 Detection: RI
 Injection: 20 µL

Sample:

1. Maltotriose
2. Sucrose
3. Glucose
4. Galactose
5. Fructose
6. Mannitol
7. Arabitol
8. Sorbitol

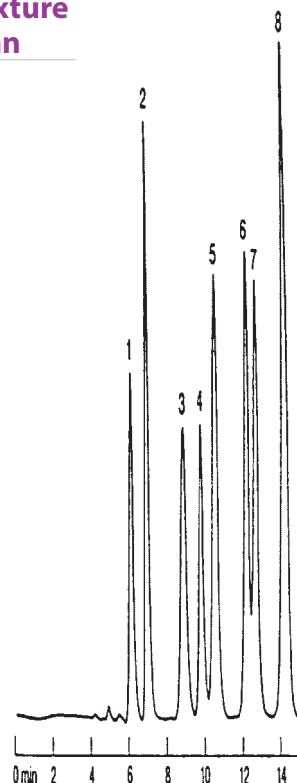

Saccharides and Sugar Alcohol Separation on CARBOsep CHO-820

Analysis Conditions:

Column: CHO-820
 Eluent: Distilled Water
 Flow rate: 0.5 mL/min
 Temperature: 90°C
 Detection: RI
 Injection: 20µL

Sample:

1. Maltotriose
2. Cellobiose
3. Glucose
4. Mannose
5. Arabinose
6. Adonitol
7. Arabitol
8. Xylitol

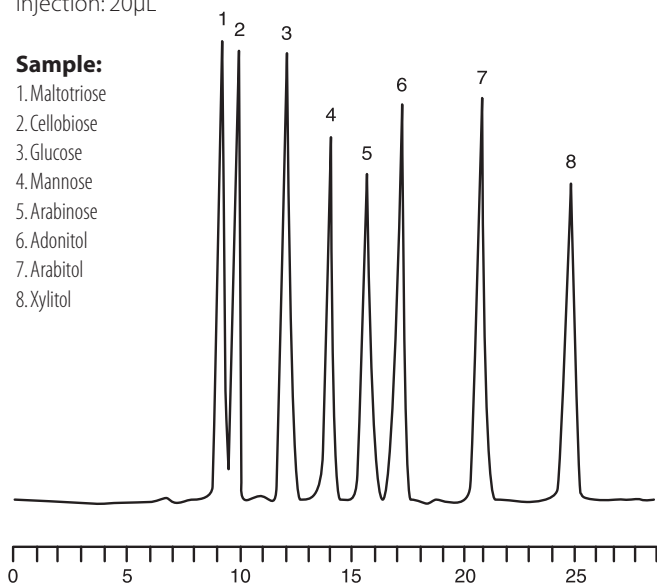

Separation of Carbohydrate Standard

Analysis Conditions:

Column: CHO-820
 Eluent: H₂O
 Flow rate: 0.5 mL/min
 Temperature: 90°C
 Detection: DRI

Sample:

1. Raffinose
2. Sucrose
3. Glucose
4. Galactose
5. Fructose
6. Mannitol
7. Sorbitol

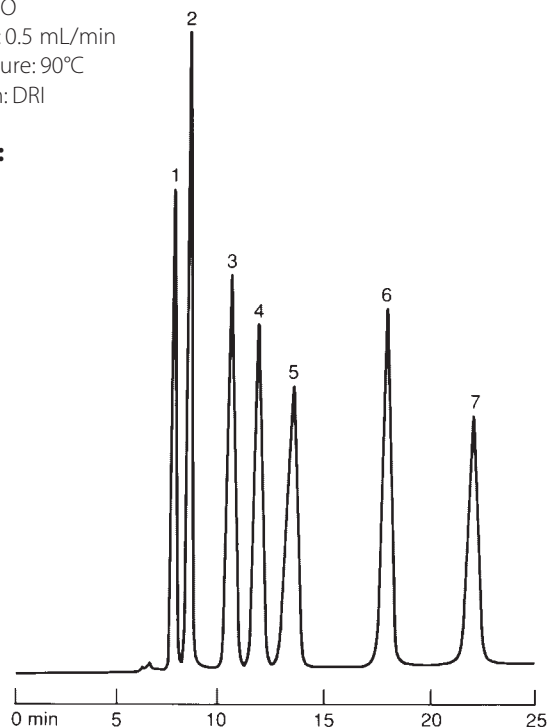



CARBOsep COREGEL-87MM Column

Analysis Conditions:

Eluent: H₂O
 Flow Rate : 0.6mL/min
 Detector: RI
 Temperature: 85 °C

Sample:

1. DP4+
2. DP4
3. DP3
4. Maltose
5. Glucose
6. Galactose
7. Fructose
8. Mannitol
9. Sorbitol

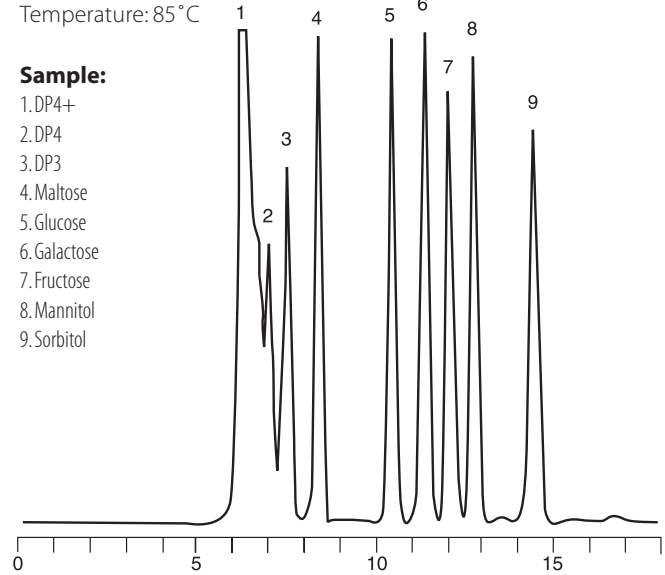

Standards

Analysis Conditions:

Column: CHO-611
 Eluent: H₂O
 Flow rate: 0.5 mL/min
 Temperature: 90°C
 Detection: DRI
 Injection: 20 µL

Sample:

1. Maltose
2. Glucose
3. Fructose (7 mg/mL each)

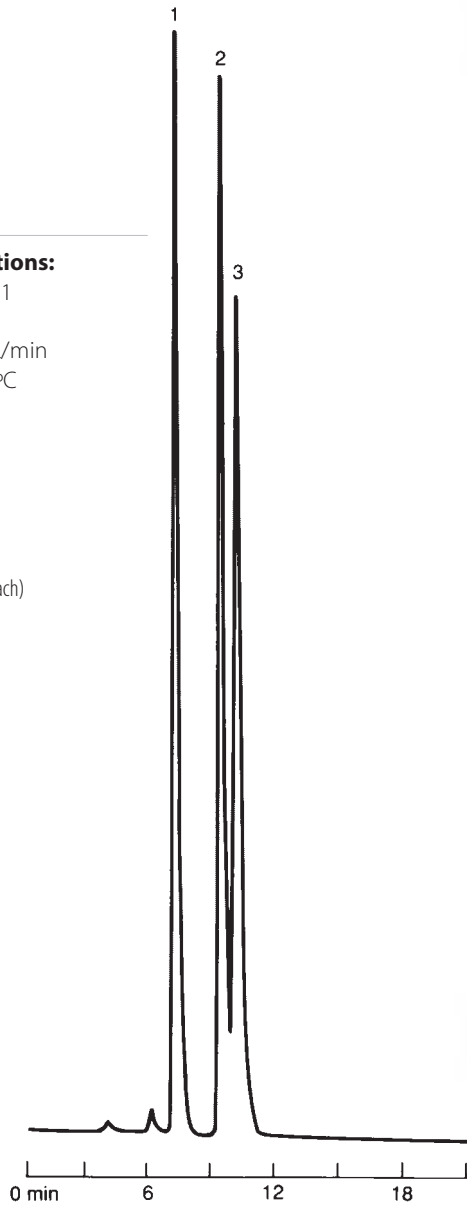

CARBOsep COREGEL-42Ag Column

Analysis Conditions:

Eluent: H₂O
 Flow Rate : 0.4mL/min
 Detector: RI
 Temperature: 75 °C

Sample:

Corn Syrup

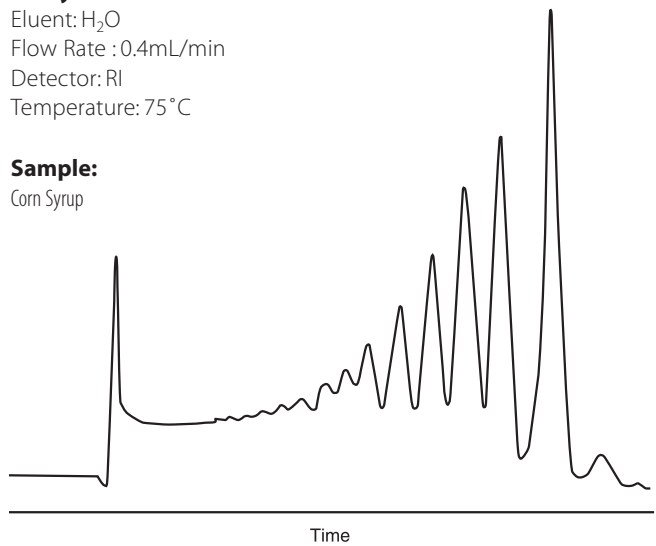

CARBOsep CHO-620

(6.5 x 300mm)

P/N CHO-99-9753

- Calcium form ligand-exchange column
- Ideal for the separation of monosaccharides and sugar alcohols
- Very reproducible

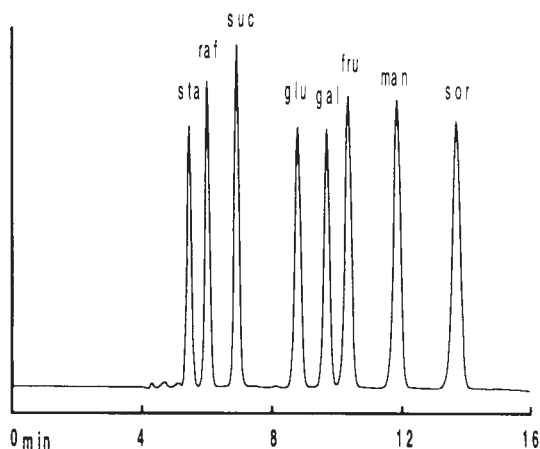

CARBOsep CHO-620 Guard Kit

P/N CHO-99-2353

CARBOsep CHO-620 Guard Cartridge – 2/PK

P/N CHO-99-1353

CARBOsep CHO-682 Lead

(7.8 x 200mm)

P/N CHO-99-8854

(7.8 x 300mm)

P/N CHO-99-9854

- Lead form ligand-exchange column
- Ideal for the separation of mono and disaccharides as well as alcohols
- High capacity

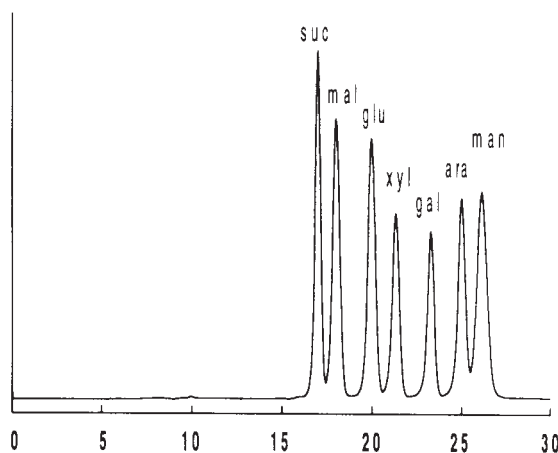

CARBOsep CHO-682 Guard Kit

P/N CHO-99-2354

CARBOsep CHO-682 Guard Cartridge – 2/PK

P/N CHO-99-1354

CARBOsep CHO-820 Calcium

(7.8 x 200mm)

P/N CHO-99-8855

(7.8 x 300mm)

P/N CHO-99-9855

- Calcium form ligand-exchange column
- Designed with balance of resolution and ruggedness

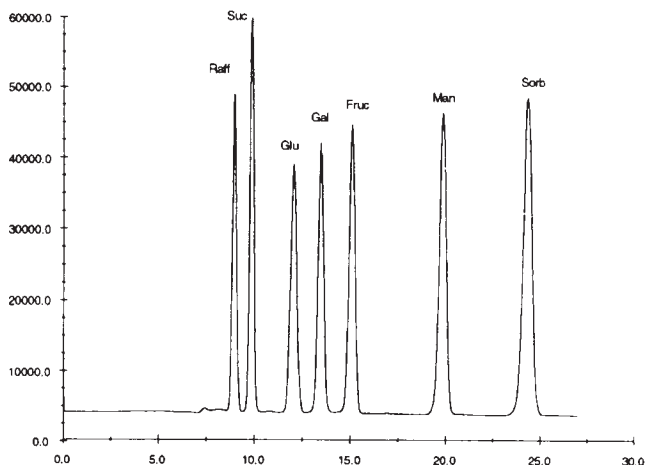

CARBOsep CHO-820 Guard Kit

P/N CHO-99-2355

CARBOsep CHO-820 Guard Cartridge – 2/PK

P/N CHO-99-1355

CARBOsep CHO-611 OH**(6.5 x 150mm)****P/N CHO-99-7752**

- Sodium form ligand-exchange column
- Designed for use with Sodium Hydroxide eluant
- Compatible with amperometric detection

CARBOsep CHO-611 OH Guard Kit**P/N CHO-99-2352****CARBOsep CHO-611 OH
Guard Cartridge – 2/PK****P/N CHO-99-1352****CARBOsep CHO-411****(7.8 x 300mm)****P/N CHO-99-9850**

- Sodium form mixed-mode column
- Separates by both ligand exchange and size exclusion
- Designed for the separation of oligosaccharides up to DP10
- Reproducible separation of corn syrup

CARBOsep CHO-611 Guard Kit**P/N CHO-99-2351****CARBOsep CHO-611 Guard Cartridge – 2/PK****P/N CHO-99-1351****CARBOsep CHO-611****(6.5 x 300mm)****P/N CHO-99-9751**

- Sodium form mixed-mode column
- Separates by both ligand exchange and size exclusion
- Designed for the separation of oligosaccharides up to DP5
- Reproducible separation of corn syrup

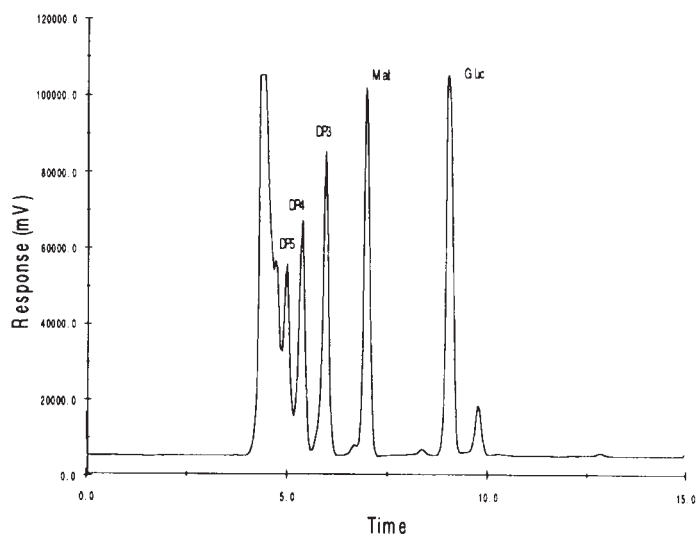
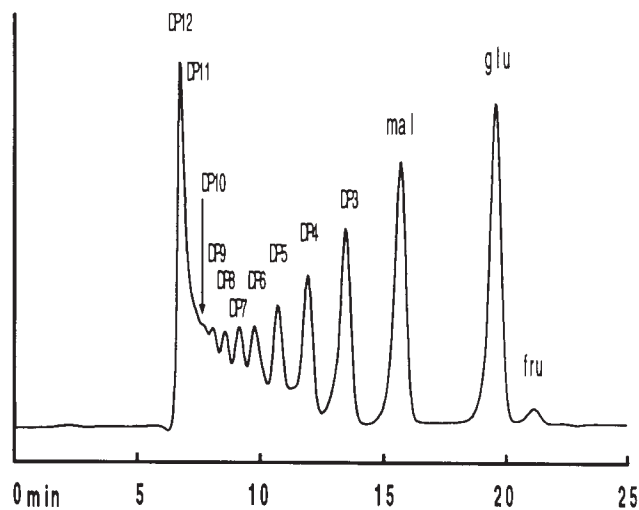
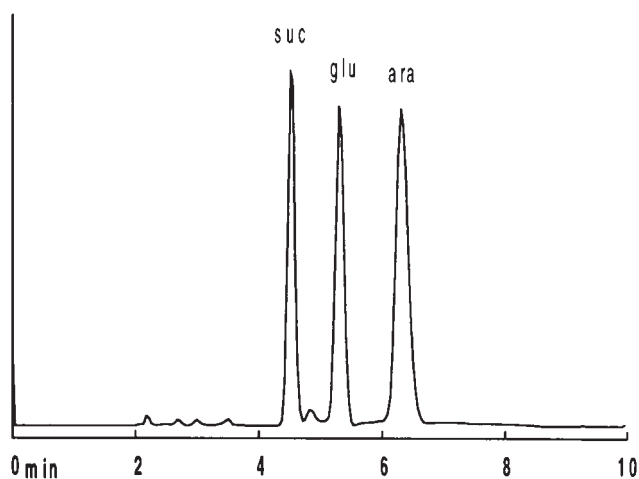
CARBOsep CHO-611 Guard Kit**P/N CHO-99-2351****CARBOsep CHO-611 Guard Cartridge – 2/PK****P/N CHO-99-1351**

CARBOsep USP L19 CA-FORM

(4.0 x 250mm)

P/N CHO-99-8453

- Calcium form ligand-exchange column
- Complies with USP L-19 specifications for the separation of sorbitol and mannitol
- Can also separate a wide number of other carbohydrates

CARBOsep CHO-820 Guard Kit

P/N CHO-99-2355

CARBOsep CHO-820 Guard Cartridge – 2/PK

P/N CHO-99-1355

CARBOsep COREGEL-87C

(7.8 x 300)

P/N CHO-99-9860

- Calcium form 9µm ligand exchange resin with 8% cross-linking
- Compatible replacement for the Bio-Rad Aminex HPX 87C
- Designed for the analysis of sugars and sugar alcohols

CARBOsep COREGEL-87C Guard Kit

P/N CHO-99-2360

CARBOsep COREGEL-87C Guard Cartridge – 2/PK

P/N CHO-99-1360

CARBOsep COREGEL-87K

(7.8 x 300)

P/N CHO-99-9862

- Potassium form 8µm ligand exchange resin with 8% cross-linking
- Compatible replacement for the Bio-Rad Aminex HPX 87K
- Target application corn syrup and molasses

CARBOsep COREGEL-87K Guard Cartridge – 2/PK

P/N CHO-99-1362

Universal Guard Cartridge Holder

P/N AXC-99-1300

Separation for USP L-19 Analysis

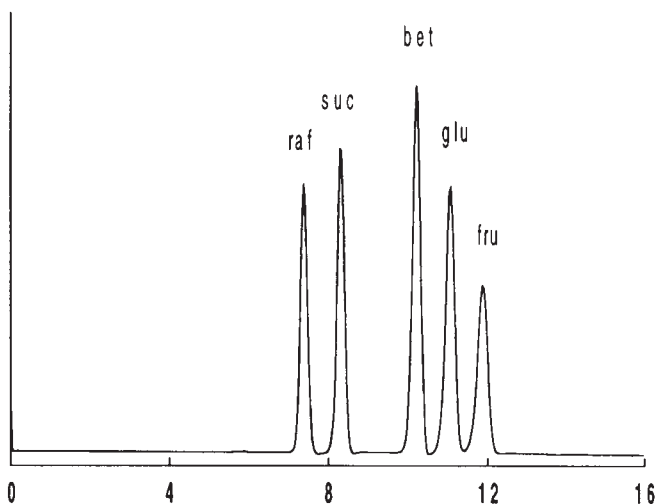
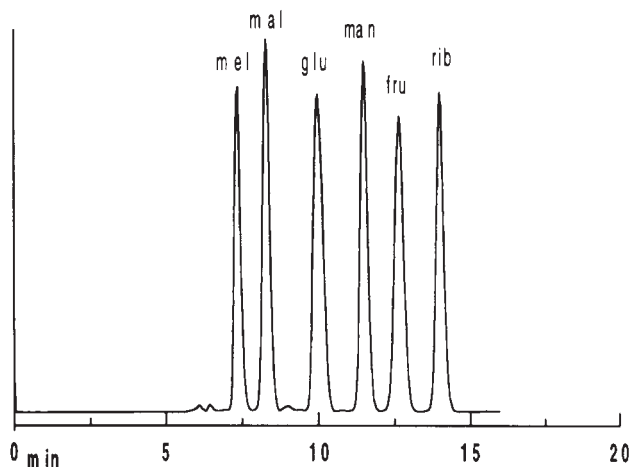
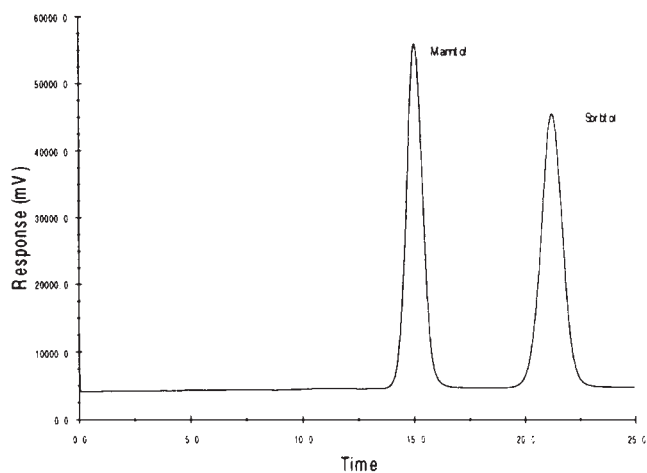

CARBOsep COREGEL-87N**(7.8 x 300mm)****P/N CHO-99-9863**

- Sodium form 8µm ligand exchange resin with 8% cross-linking
- Compatible replacement for the Bio-Rad Aminex HPX 87N
- Designed for the fast separation of monosaccharides and sugar alcohols

**CARBOsep COREGEL-87N
Guard Cartridge – 2/PK****P/N CHO-99-1363****Universal Guard Cartridge Holder****P/N AXC-99-1300****CARBOsep COREGEL-87P****(7.8 x 300mm)****P/N CHO-99-9864**

- Lead form 8µm ligand exchange resin with 8% cross-linking
- Compatible replacement for the Bio-Rad Aminex HPX 87P
- Optimized for the analysis of cellulose hydrolysates

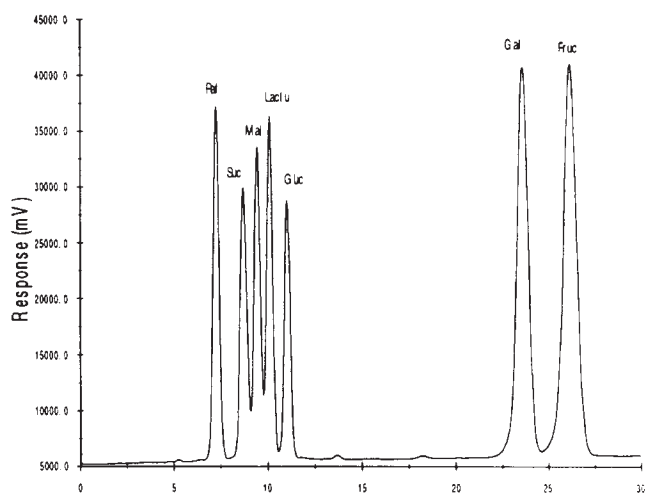
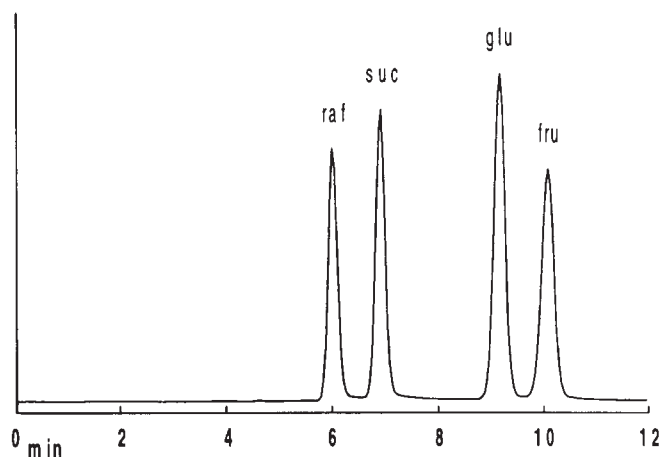
**CARBOsep COREGEL-87P
Guard Cartridge – 2/PK****P/N CHO-99-1364****Universal Guard Cartridge Holder****P/N AXC-99-1300**



CARBOsep COREGEL-87MM

(7.8 x 300mm)

P/N CHO-99-9865

- Mixed calcium/sodium form ligand-exchange column
- Increased efficiency of glucose, fructose, and sugar alcohols
- Easily cleaned with EDTACaNa₂

CARBOsep COREGEL-87MM Guard Cartridge 2/PK

P/N CHO-99-1365

Universal Guard Cartridge Holder

P/N AXC-99-1300

Analysis Conditions:

Eluent: Water
Flow rate: 0.6 mL/min
Detector: RI

Sample:

1. Sucrose
2. Glucose
3. Fructose
4. Arabinose

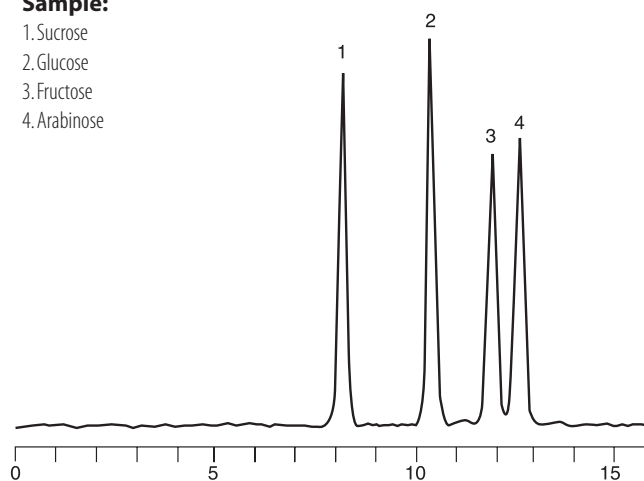

CARBOsep COREGEL-42Ag

(7.8 x 300mm)

P/N CHO-99-9851

- Silver form ligand-exchange column
- Separate oligosaccharides up to DP11
- Compatible replacement for the Bio-Rad Aminex HPX-42A column

CARBOsep COREGEL-42Ag Guard Cartridge 2/PK

P/N CHO-99-1366

Universal Guard Cartridge Holder

P/N AXC-99-1300

Analysis Conditions:

Eluent: H₂O
Flow rate: 0.4 mL/min
Detector: RI

Sample:

Maltooligosaccharides

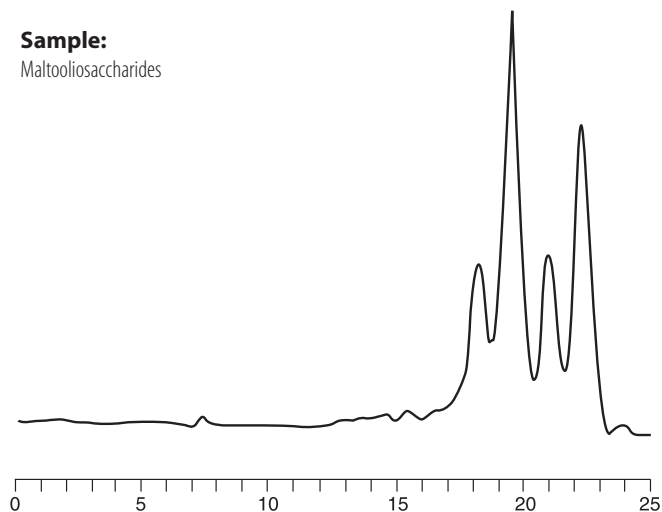

ORGANIC ACID *Analysis*

ICSep Columns for Organic Acid Analysis

Ion exclusion is the preferred method for the separation of weakly ionizable species such as organic acids and alcohols.

Transgenomic provides a broad range of columns that provide varying efficiencies and selectivities for the separation of weak acids by ion exclusion.

The packings employed with ion exclusion are totally sulfonated polystyrene divinylbenzene (PS/DVB) copolymers. By totally sulfonating the polymer, the bead behaves as though it were a negatively charged sphere. This charged sphere is referred to as a Donnan membrane. Species that have a negative charge are repelled from the negatively charged membrane, while uncharged species are allowed to enter the sphere and adsorb onto the beads. The mobile phases employed with ion exclusion are low concentration acids, such as 5mM sulfuric acid.



This equilibrium is regulated by the acidic dissociation constant (pKa) of the organic acid or alcohol. Therefore, species are analyzed by ion exclusion and elute according to their pKa.

Features

The key features of the ICsep ion exclusion columns are:

- **Polymeric Substrate**
- **High efficiency**
- **High resolution**
- **Separates organic acids, carbohydrates, and alcohols on the same column**
- **Very Rugged Design which provides long life**

Since ICsep columns are based on a polymeric substrate consisting of polystyrene/divinylbenzene copolymers they are stable in the pH range of 0 to 14, temperature stable, and very rugged. The ICsep organic acid columns have been shown to last for thousands of runs without cleaning. They show very good lot-to-lot and column-to-column reproducibility with retention times varying by less than 1%.

Transgenomic offers ICsep organic acid columns to meet your analytical needs. ICsep columns are available that focus on speed or efficiency and there are ICsep ion exclusion columns that focus on ruggedness and the ability to handle dirty samples. There are even ICsep columns for aromatic organic acids. Transgenomic is sure to have an ion exclusion column to meet your needs.

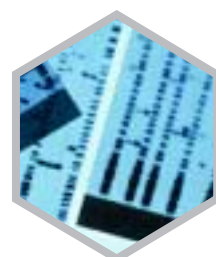

Selectivity Chart for Ion Exclusion Columns

Compound	Coregel 87H @ 85°C (units in minutes)	Coregel 64H @ 65°C (units in minutes)	ION-300 @ 65°C (units in minutes)	ORH-801 @ 45°C (units in minutes)
Acetic acid	13.8	15.0	14.9	10.4
Acetoacetic acid	nd	nd	nd	10.2
Aconitic acid	8.6	9.8	10.7	7.2
Acrylic acid	15.9	17.7	17.9	13.1
Adipic acid	12.5	15.1	15.8	11.6
Butanol	32.9	35.1	25.2	18.4
Butyric acid	18.4	21.0	20.8	15.2
Citraconic acid	10.1	11.0	11.5	nd
Citric acid	7.5	8.0	8.6	5.5
Ethanol	21.4	21.7	20.6	14.6
Formic acid	12.9	13.8	13.9	9.6
Fumaric acid	11.5	13.4	14.7	10.0
2-Furoic acid	22.1	26.9	29.0	22.0
Glucuronic acid	nd	nd	nd	5.3
Glycolic acid	11.4	13.0	12.9	8.5
Glyoxylic acid	9.2	9.7	10.3	6.5
Hydroxybutyric acid	12.8	14.0	14.1	9.5
Iso-butyric acid	17.3	19.6	19.5	14.0
Itaconic acid	11.1	12.8	13.4	9.1
Keto-butyric acid	nd	nd	11.4	7.4
Keto-glutaric acid	7.8	8.2	nd	5.6
Keto-valeric acid	11.7	12.6	13.1	8.6
Lactic acid	11.9	12.9	11.6	8.7
Maleic acid	8.2	8.6	9.0	5.9
Malic acid	8.8	9.6	10.3	6.6
Malonic acid	9.3	10.0	10.7	6.9
Methanol	18.7	19.0	18.7	12.9
Methylglutaric acid	11.8	13.9	14.5	10.0
Methylsuccinic acid	10.9	12.5	13.0	8.8
Oxalic acid	6.7	6.6	nd	4.5
Propanol	25.9	26.7	22.2	16.1
Propionic acid	15.8	17.4	17.4	12.3
Pyruvic acid	9.2	9.5	9.9	6.3
Quinic acid	9.4	10.3	11.4	6.9
Shikimic acid	10.5	11.8	12.9	8.2
Succinic acid	10.4	11.7	12.2	8.2
Tartaric acid	8.0	8.6	9.5	5.9

Flow rate: 0.6 mL/minute. nd = not determined



Standard Mixture of Sugars and Acids

Analysis Conditions:

Column: ION-300
 Eluent: 0.0085 N H₂SO₄
 Flow rate: 0.4 mL/min
 Temperature: 70°C
 Detection: DRI

Sample:

1. Citric Acid
2. Tartaric Acid
3. Glucose
4. Malic Acid
5. Fructose
6. Lactic Acid
7. Glycerol
8. Acetic Acid
9. Methanol
10. Ethanol

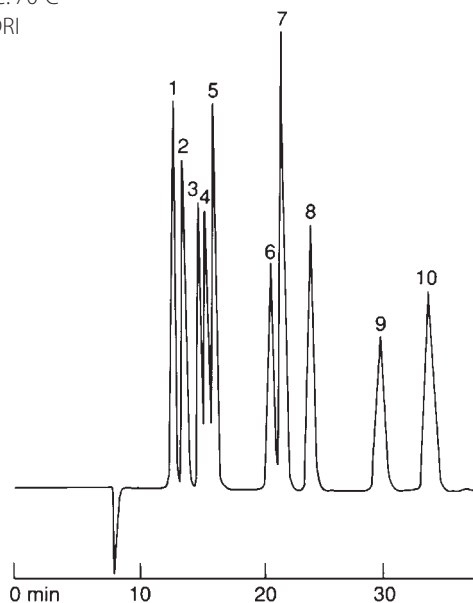

Krebs Tricarboxylic Acid Cycle Intermediates

Analysis Conditions:

Column: ION-300
 Eluent: 0.01 N H₂SO₄
 Flow rate: 0.4 mL/min
 Temperature: 42°C
 Detection: DRI

Sample:

1. Cis-Aconitic Acid
2. Oxaloacetic Acid
3. Citric Acid
4. α -ketoglutaric Acid
5. Pyruvic Acid
6. Malic Acid
7. Lactic Acid
8. Succinic Acid
9. Fumaric Acid

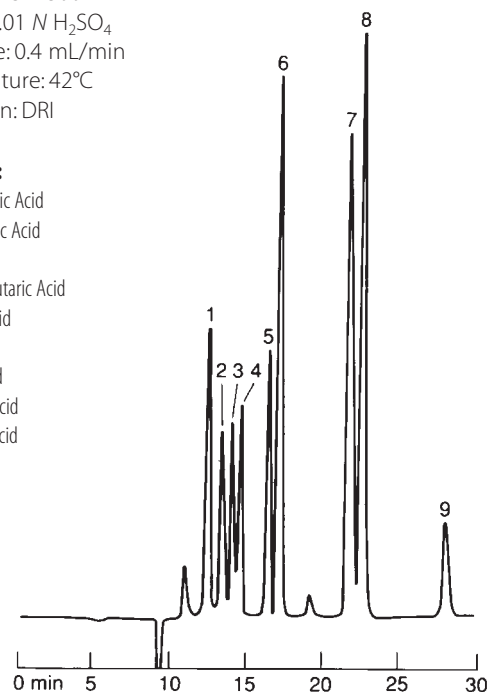

Comparison of Organic Acids Retention on Ion-exclusion Columns

Analysis Conditions:

Column: ION-310 (6.5 x 150 mm),
 ORH-801 (6.5 x 300 mm),
 ION-300 (7.8 x 300 mm)
 Eluent: 0.002 N H₂SO₄
 Flow rate: 0.5 mL/min
 Temperature: 35°C
 Detection: UV at 210 nm
 Injection: 20 μ L

Sample:

1. Maleic Acid (2 ppm)
2. Malic Acid (100 ppm)
3. Fumaric Acid (5 ppm)

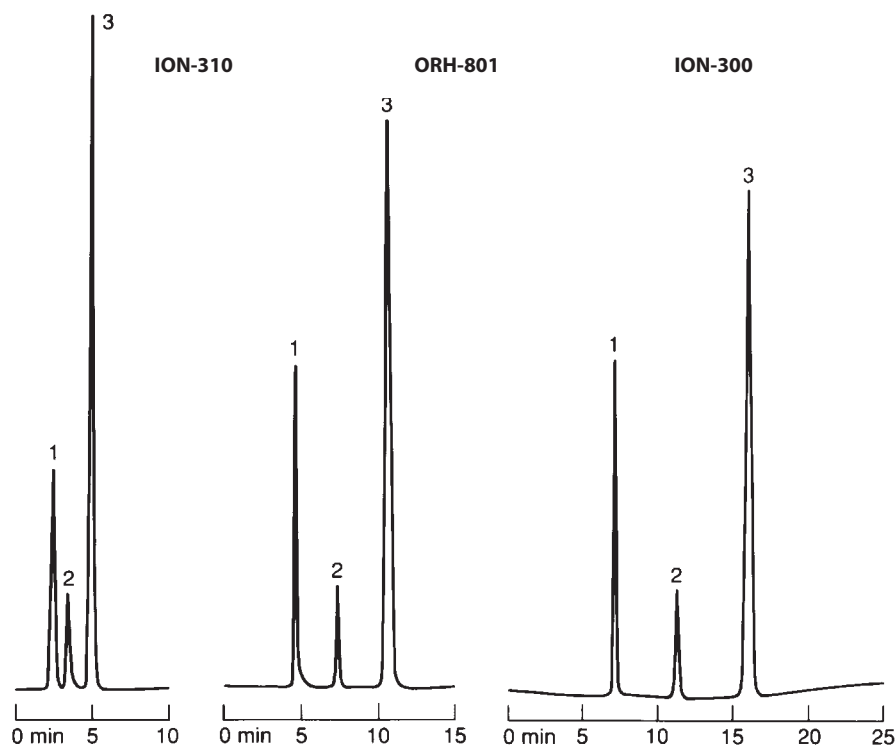

Borate and Bicarbonate**Analysis Conditions:**

Column: ION-310
 Eluent: 0.05 M H₂SO₄
 Flow rate: 0.5 mL/min
 Temperature: Ambient
 Detection: Conductivity
 Injection: 20 µL

Sample:

1. Borate (11 ppm)
2. Bicarbonate (60 ppm)

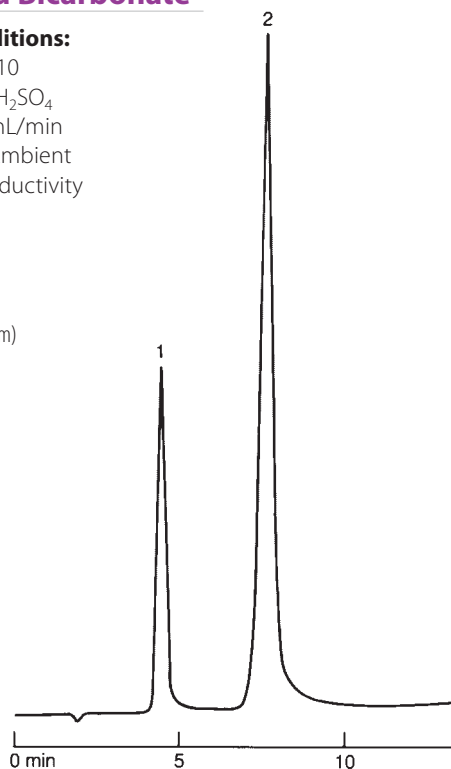
**Wine Analysis by High Resolution Ion Exclusion****Analysis Conditions:**

Column: ION-300
 Eluent: 0.005 N H₂SO₄
 Flow rate: 0.3 mL/min
 Temperature: 60°C
 Detection: DRI

Sample:

1. Citric Acid
2. Tartaric Acid
3. Glucose
4. Malic Acid
5. Fructose
6. Acetic Acid
7. Glycerol
8. Lactic Acid
9. Methanol
10. Ethanol

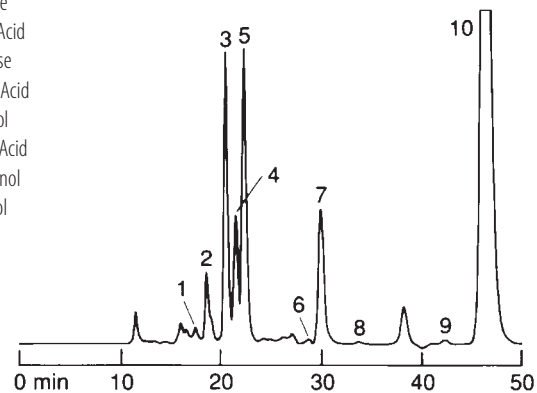
**Analysis of Corn Mash Fermentation Sample****Analysis Conditions:**

Column: ION-300
 Eluent: 0.005 N H₂SO₄
 Flow rate: 0.4 mL/min
 Temperature: 60°C
 Detection: UV at 210
 Injection: 20 µL filtered corn mash fermentation broth

Sample:

1. Citric, Isocitric
2. Pyruvic
3. Succinic
4. Fumaric
5. Ethanol

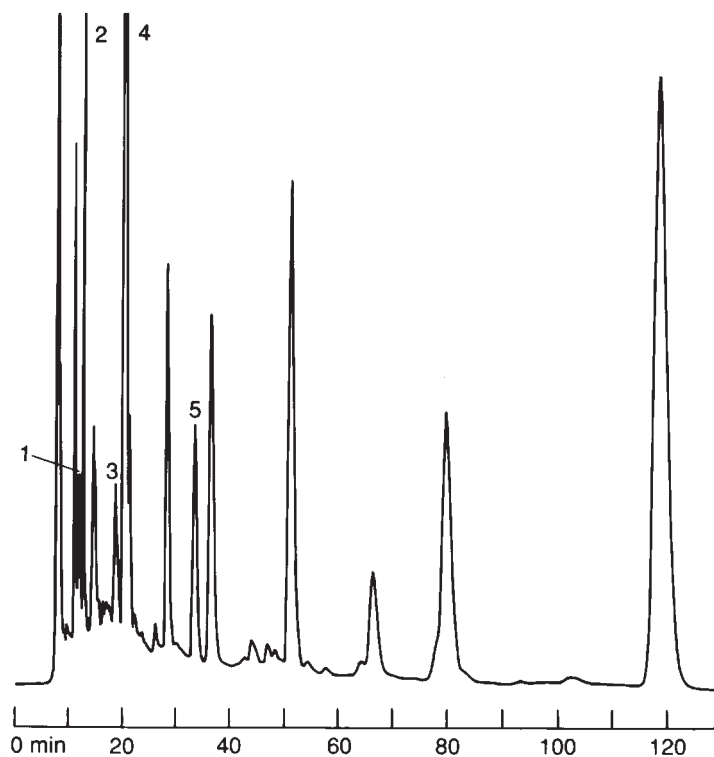

Fermentation Broth

Analysis Conditions:

Column: ORH-801
 Eluent: 0.0025 N H₂SO₄
 Flow rate: 0.6 mL/min
 Temperature: 65°C
 Detection: RI
 Injection: 20 µL

Sample:

1. Maltotriose
2. Maltose
3. Glucose
4. Fructose
5. Lactic Acid
6. Glycerol
7. Acetic Acid
8. Methanol
9. Ethanol

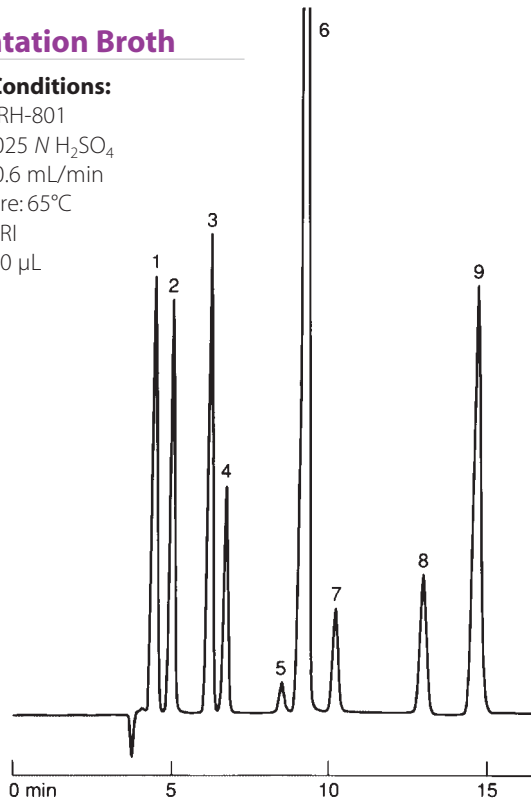

Preservatives in Container Citrus Juice

Analysis Conditions:

Column: ARH-601
 Eluent: 0.01 N H₂SO₄
 Flow rate: 0.6 mL/min
 Temperature: 45°C
 Detection: UV at 228 nm

Sample:

1. Citric Acid
2. Ascorbic Acid
3. Sorbic Acid
4. Benzoic Acid

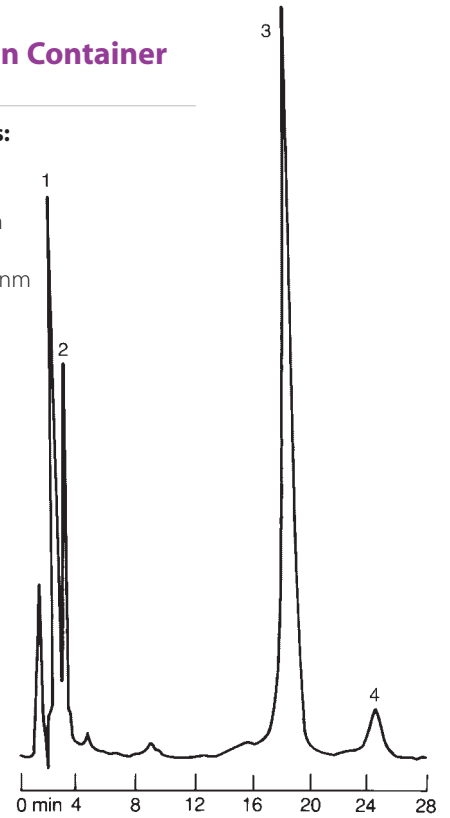

Fast Acid Analysis

Analysis Conditions:

Column: ORH-801
 Eluent: 0.01 N H₂SO₄
 Flow rate: 0.5 mL/min
 Detection: Conductivity

Sample:

1. Acetic Acid
2. Glycerol

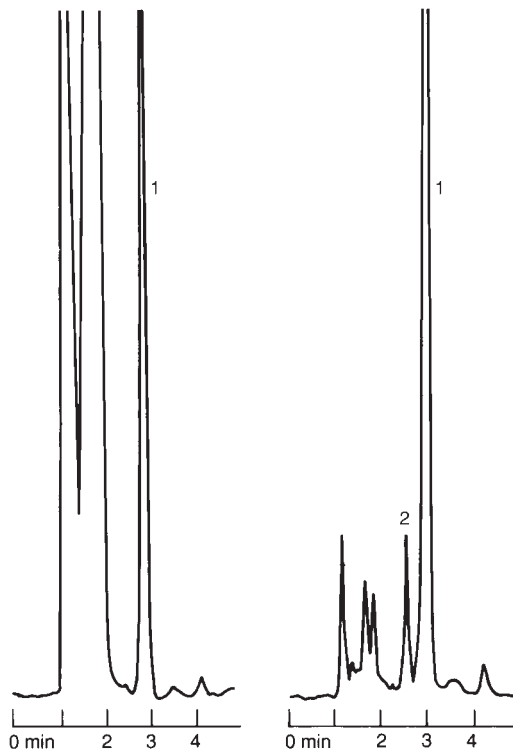

Fluoride in Dental Rinse

Analysis Conditions:

Column: ION-310
 Eluent: 0.01 N H₂SO₄
 Flow rate: 1.0 mL/min
 Temperature: 50°C
 Detection: DRI

Sample:

Dental rinse diluted 1/10
 with eluent, 20 µL

1. Phosphate
2. Saccharin
3. Glycerol
5. Ethanol

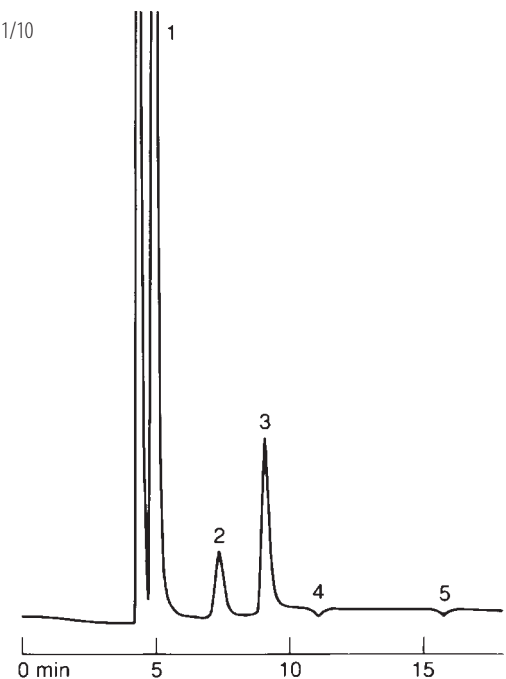

Separation of Organic Acids

Analysis Conditions:

Column: ORH-801
 Eluent: 0.01 N H₂SO₄
 Flow rate: 0.8 mL/min
 Temperature: 35°C
 Detection: DRI
 Injection: 20 µL

Sample:

1. Oxalic
2. cis-aconitic
3. Tartaric
4. Malic
5. Lactic
6. Formic
7. Fumaric
8. Propionic
9. Butyric

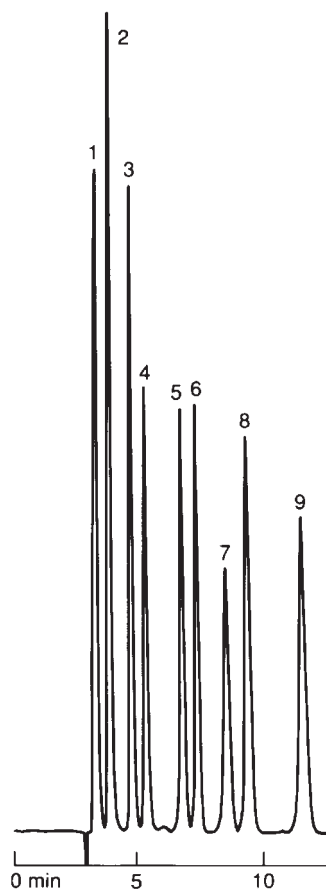

Determination of Chemical Markers for Thermal Processing of Ground Meat

Analysis Conditions:

Column: Coregel-87H
 (100 x 7.8 mm)
 Eluent: 0.005 N H₂SO₄
 Flow rate: 1.0 mL/min
 Temperature: 35°C
 Detection: UV at 285 nm
 Injection: 20 µL

Sample:

1. M1
2. M2
3. M3

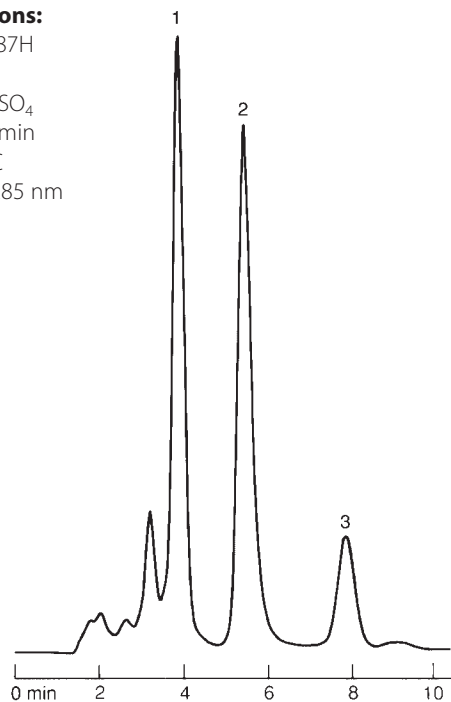

USP-NF Malic Acid Method, Fumaric and Maleic Acids

Analysis Conditions:

Column: ORH-801
 packing L17 specification
 Eluent: 0.01 N H₂SO₄
 Flow rate: 0.6 mL/min
 Temperature: 37°C
 Detection: UV at 210 nm
 Injection: 20 µL

Sample: USP Malic Acid

(100 mg in 100 mL volumetric flask, made up with 0.01 N H₂SO₄)

1. Maleic Acid
2. Malic Acid
3. Fumaric Acid

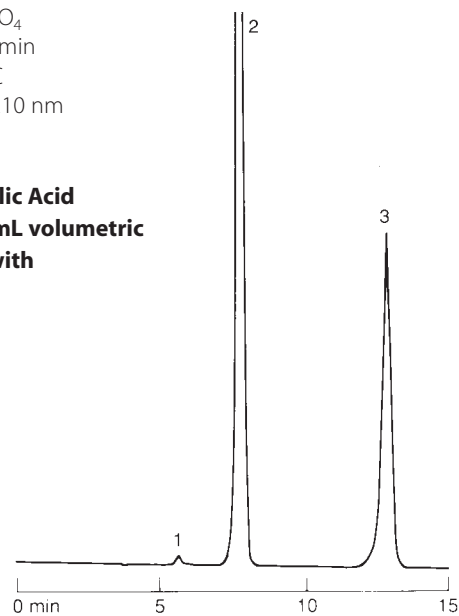

Organic Acid Separation on COREGEL-87H1

Analysis Conditions:

Column: COREGEL-87H1
 Eluent: 5mM Sulfuric Acid
 Flow rate: 1.0 mL/min
 Temperature: 35°C
 Detection: UV @ 210nm
 Injection: 20µL

Sample:

1. Lactic Acid (2.0 mg/mL)
2. Acetic Acid (2.0 mg/mL)
3. Propionic Acid (2.0 mg/mL)
4. alpha-Butyric Acid (1.0 mg/mL)
5. Glutamic Acid (2.0 mg/mL)

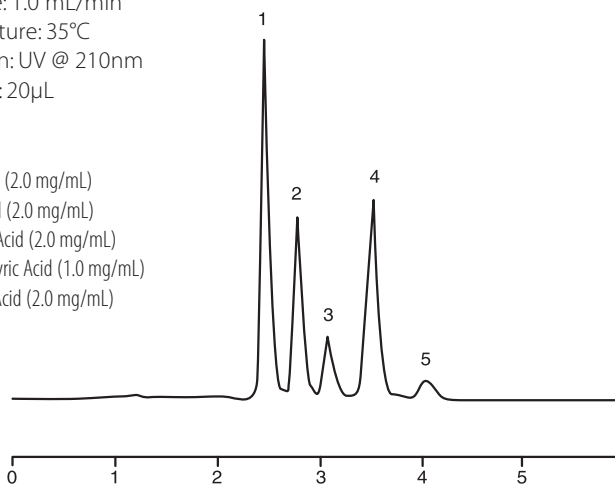

ICSep COREGEL-87H1

(7.8 x 100mm)
 P/N ICE-99-5861

Organic Acid Separation on COREGEL-87H3

Analysis Conditions:

Column: COREGEL-87H3
 Eluent: 0.008M Sulfuric Acid
 Flow rate: 0.6 mL/min
 Temperature: 35°C
 Detection: UV @ 210nm
 Injection: 20µL

Sample:

1. Lactic Acid
2. Formic Acid
3. Acetic Acid
4. Propionic Acid
5. Butyric Acid

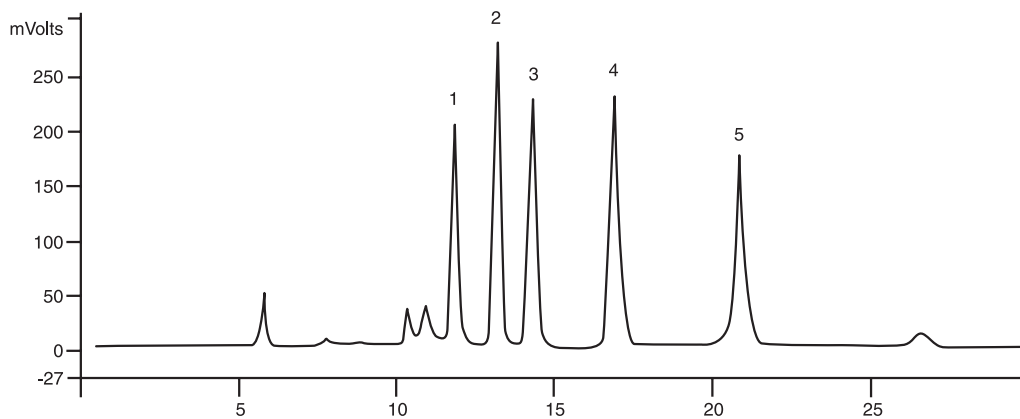

ICSep COREGEL-87H3

(7.8 x 300mm)
 P/N ICE-99-9861

ICSep COREGEL 87H Guard Kit

P/N ICE-99-2361

ICSep COREGEL 87H Guard Cartridge – 2/PK

P/N ICE-99-2371

ICSep ION-300

(7.8 x 300mm)

P/N ICE-99-9850

- Select when high resolution is the primary concern
- Separates Organic Acids, Alcohols and Carbohydrates all on the same column

ICSep GC-801 Guard Kit

P/N ICE-99-2354

ICSep GC-801 Guard Cartridge – 2/PK

P/N ICE-99-2364

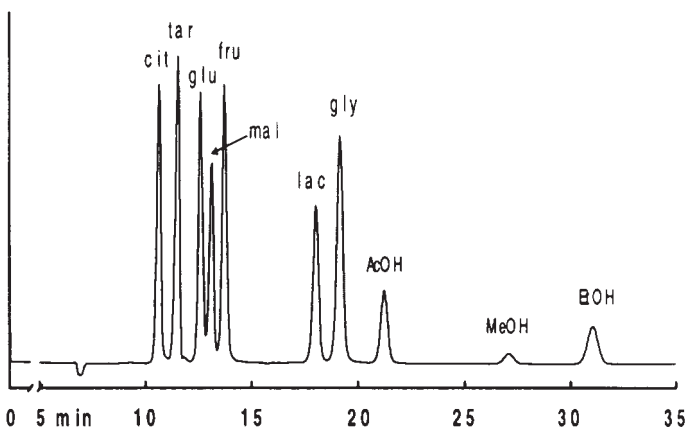



ICSep COREGEL-107H

(7.8 x 300mm)

P/N ICE-99-9866

- New Higher Cross-linked Column
- Improved Resolution for Organic Acids

ICSep COREGEL-107H Guard Cartridge – 2/PK

P/N ICE-99-2366

Universal Guard Cartridge Holder

P/N AXC-99-1300

Organic Acid Separation Comparison on the NEW ICsep COREGEL-107H and Competitive Organic Acid Column

Analysis Conditions:

Column: COREGEL-107H and Competitive Organic Acid Column

Eluent: 0.008N Sulfuric Acid

Flow rate: 0.6 mL/min

Temperature: 35°C

Detection: UV @ 210nm

Injection: 20µL

Sample:

1. Citric Acid
2. Alpha Ketoglutaric Acid
3. Fumaric Acid
4. Acetic Acid

ICSep COREGEL-107H

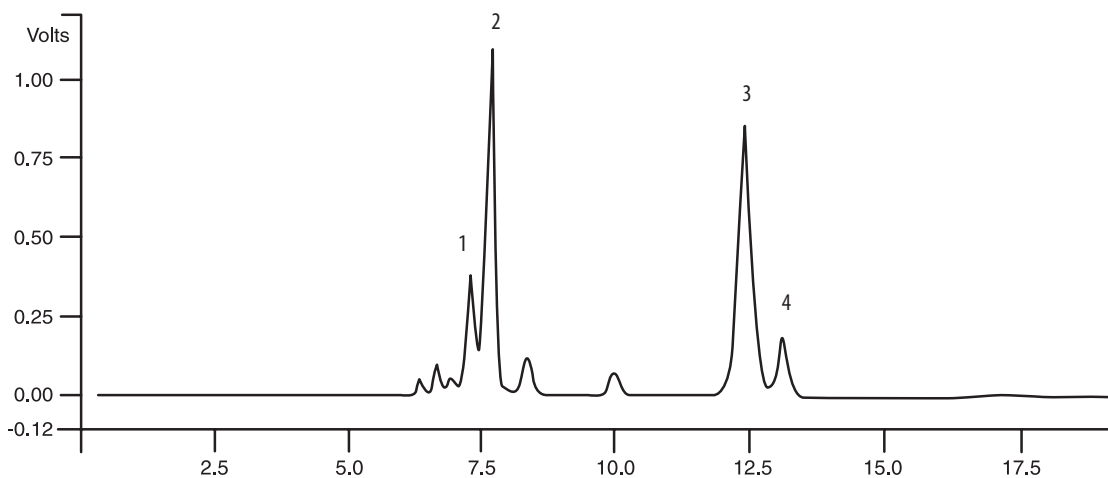

Competitive Organic Acid Column

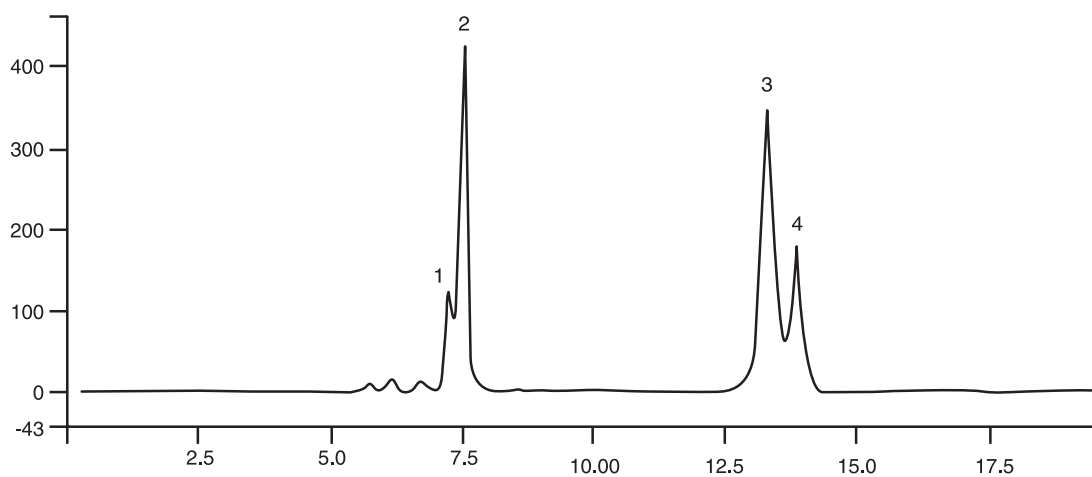

ICSep ORH-801**(6.5 x 300mm)****P/N ICE-99-9754**

- Provides good balance of high efficiency and ruggedness
- Versatile column for Organic Acids, Alcohols and Carbohydrates

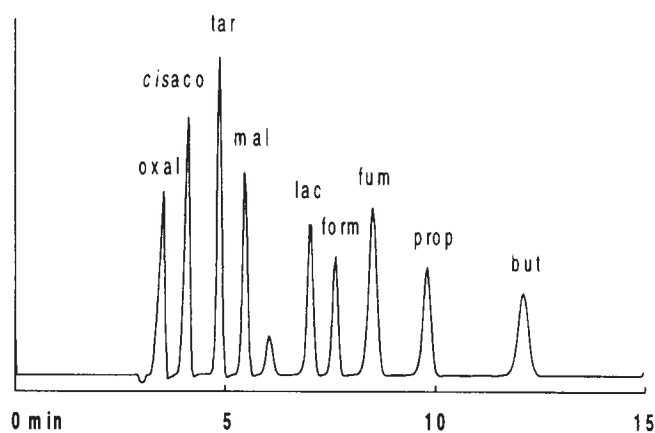
ICSep GC-801 Guard Kit**P/N ICE-99-2354****ICSep GC-801 Guard Cartridge – 2/PK****P/N ICE-99-2364****Sugar and Organic Acid Separation on ICSep Wine Analysis WA-1****Analysis Conditions:**

Column: Wine Analysis WA-1
 Eluent: 0.0025N Sulfuric Acid
 Flow rate: 0.6 mL/min
 Temperature: 45°C
 Detection: RI
 Injection: 20µL

Sample:

1. Citric Acid (0.5 mg/mL)
2. Tartaric Acid (2.0 mg/mL)
3. Glucose (2.0 mg/mL)
4. Malic Acid (1.0 mg/mL)
5. Fructose (2.0 mg/mL)
6. Succinic Acid (0.5 mg/mL)
7. Lactic Acid (2.0 mg/mL)
8. Glycerine (5.0 mg/mL)
9. Acetic Acid (0.5 mg/mL)
10. 2,3-Butanediol (0.5 mg/mL)
11. Isomer Impurity
12. Ethanol (10.0 mg/mL)

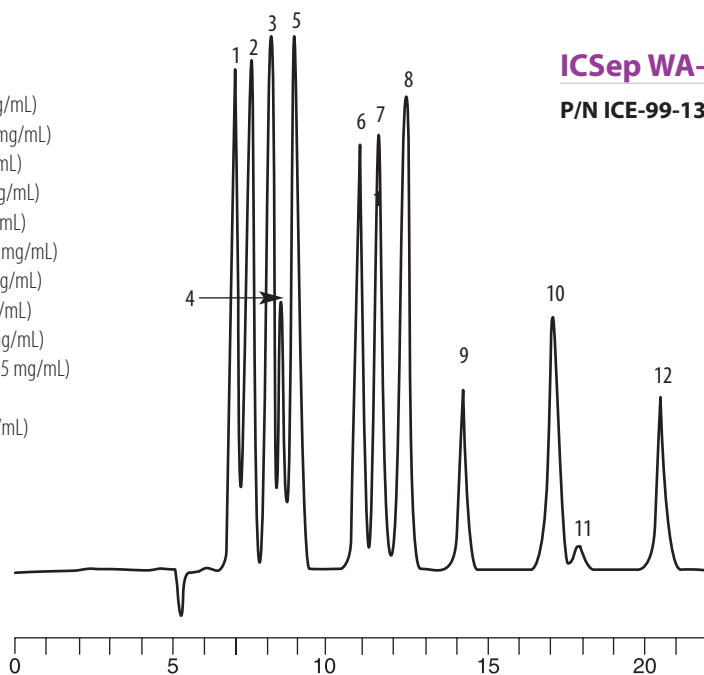
**ICSep WA-1 Wine Analysis Column****(7.8 x 300mm)****P/N ICE-99-9810****ICSep WA-1 Wine Guard Kit****P/N ICE-99-3510****ICSep WA-1 Wine Guard Cartridge 2/PK****P/N ICE-99-1310**

ICSep ION-310

(6.5 x 150mm)

P/N ICE-99-7752

- Designed for fast analysis of organic acids and alcohols
- Ideal for the analysis of borate and bicarbonate

ICSep GC-801 Guard Kit

P/N ICE-99-2354

ICSep GC-801 Guard Cartridge – 2/PK

P/N ICE-99-2364

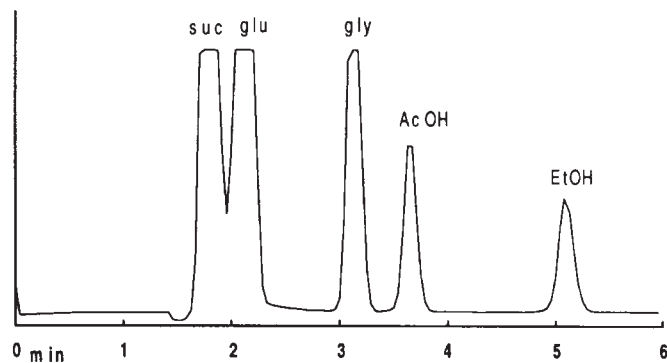
**ICSep ARH-601**

(6.5 x 100mm)

P/N ICE-99-5753

- Designed for the separation of Aromatic organic acids
- Uses aqueous mobile phases

ICSep GC-601 Guard Kit

P/N ICE-99-2353

ICSep GC-601 Guard Cartridge – 2/PK

P/N ICE-99-2363

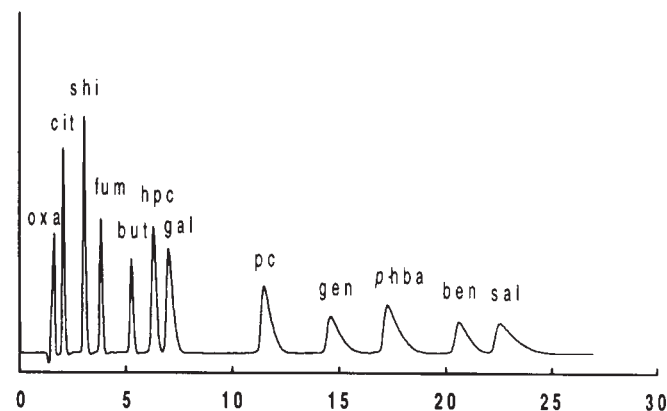
**ICSep COREGEL-64H**

(7.8 x 300mm)

P/N ICE-99-9860

ICSep COREGEL 64H Guard Kit

P/N ICE-99-2360

ICSep COREGEL 64H Guard Cartridge – 2/PK

P/N ICE-99-2370

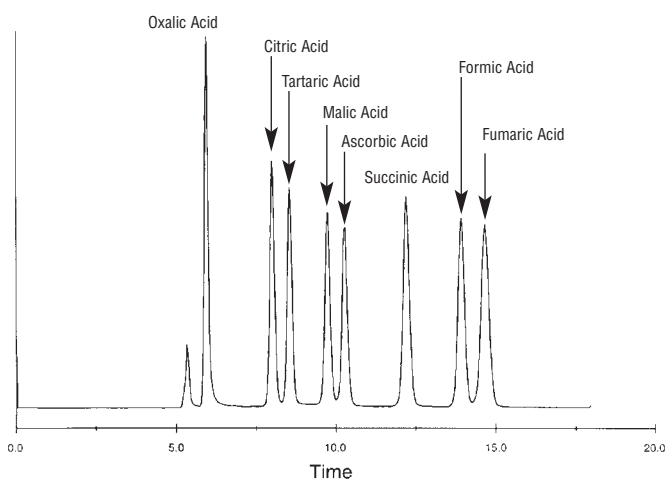

POLYMERIC REVERSED Phase

RPsep Columns

Reversed phase is commonly referred to as adsorption chromatography. Reversed phase works by taking advantage of the hydrophobic interactions between molecules and a hydrophobic stationary phase.

In reversed phase, molecules are adsorbed onto a hydrophobic stationary phase. Then, the molecules are desorbed by changing the hydrophobic character of the mobile phase such that the molecules will selectively partition into the mobile phase and elute from the column.

Traditionally, silica-based packings have been the most commonly used sorbants. However, as samples become more challenging, as with biological samples, supports are required that have broader pH ranges, are more rugged, and can be cleaned. Transgenomic provides a family of products all based on polystyrene-divinylbenzene sorbants that utilize our patented alkylation technology.

Features

The key features of RPsep polymeric reversed phase columns are:

- pH stable from 0 – 14
- temperature stable
- very rugged, long lasting materials
- very tight particle size range ($\pm 0.5\mu\text{m}$) for high efficiency
- very high efficiency for polymeric resins
- both alkylated and non alkylated PS/DVB available
- all resins available in both analytical and bulk for scalability

And, as with all Transgenomic Chromatography products, RPsep columns provide excellent column-to-column and lot-to-lot reproducibility.

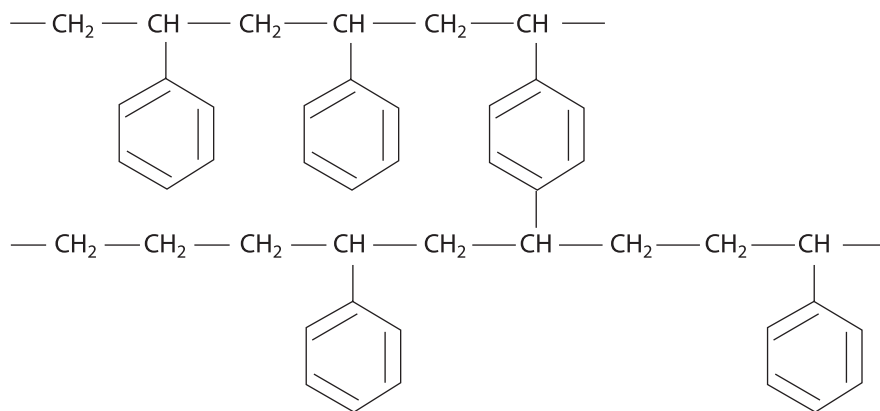

Aspirin and Salicylic Acid on Poly-RP C0

Analysis Conditions:

Column: Poly-RP C0
 Eluent: 1% H₃PO₄ (28%) in 50:50 ACN:H₂O
 Flow rate: 0.75 mL/min
 Temperature: Ambient
 Detection: UV at 254 nm

Sample:

1. Aspirin (2-(acetyloxy)-benzoic acid)
2. Benzoic Acid
3. Salicylic Acid

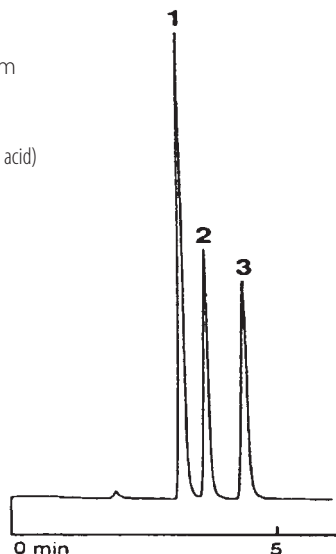

Separation of Sulfonamides on Poly-RP C0

Analysis Conditions:

Column: Poly-RP C0
 Eluent: 0.01 M KH₂PO₄
 in 25:75 ACN:H₂O
 Flow rate: 0.75 mL/min
 Detection: UV at 254 nm
 Injection: 10 µL

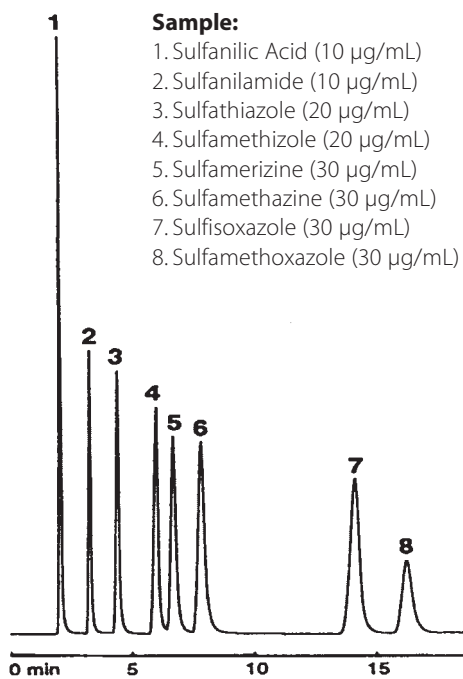

Sample:

1. Sulfanilic Acid (10 µg/mL)
2. Sulfanilamide (10 µg/mL)
3. Sulfathiazole (20 µg/mL)
4. Sulfamethizole (20 µg/mL)
5. Sulfamerizine (30 µg/mL)
6. Sulfamethazine (30 µg/mL)
7. Sulfisoxazole (30 µg/mL)
8. Sulfamethoxazole (30 µg/mL)

Separation of PGRs and Herbicides

Analysis Conditions:

Column: Poly-RP C0
 Eluent: 30:70 ACB:1% acetic acid, B: 100% ACN
 Gradient: 100% A for 4 min,
 100% A to 50% A in 8 min,
 hold for 4 min

Flow rate: 0.6 mL/min
 Temperature: Ambient
 Detection: UV at 280 nm
 Injection: 20 μ L

Sample:

1. Maleic Acid Hydrazide
2. Kinetin
3. 6-benzylaminopurine riboside
4. Colchicine
5. Indole-3-Acetic-Acid
6. α -naphthaleneactamide
7. Indole-3-Propanoic Acid
8. p-Chlorophenoxy-Acetic Acid
9. Indole-3-Butyric Acid
10. α -Naphthaleneacetic Acid
11. β -naphthalene-Acetic Acid
12. 2,4,5-trichlorophenoxyacetic Acid
13. Indole-3-Acetic Ethyl Ester

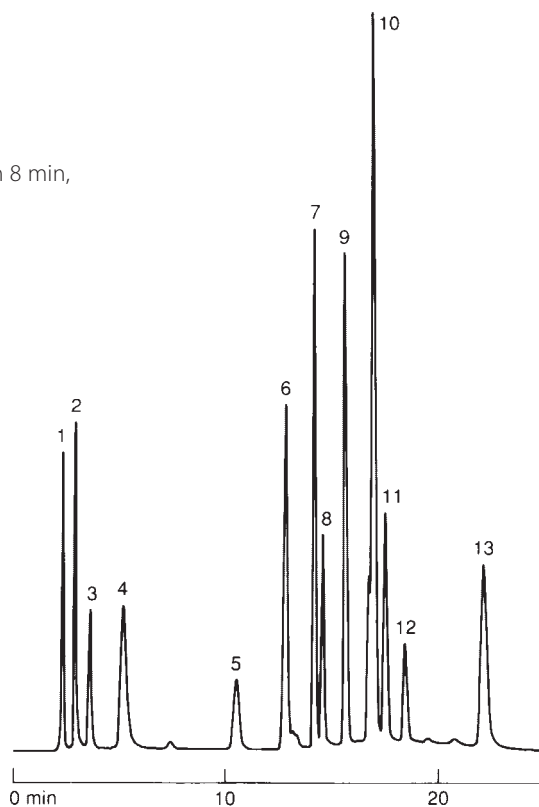

Separation of Triazine Herbicides on Poly-RP-C0

Analysis Conditions:

Column: Poly-RP C0
 Eluent: 60:40 ACN:H₂O
 Flow rate: 0.75 mL/min
 Temperature: Ambient
 Pressure: 107 Bar
 Detection: UV at 254 nm

Sample:

1. Aminotriazole
2. Simazine
3. Atrazine
4. Propazine
5. Ametryne
6. Prometryne

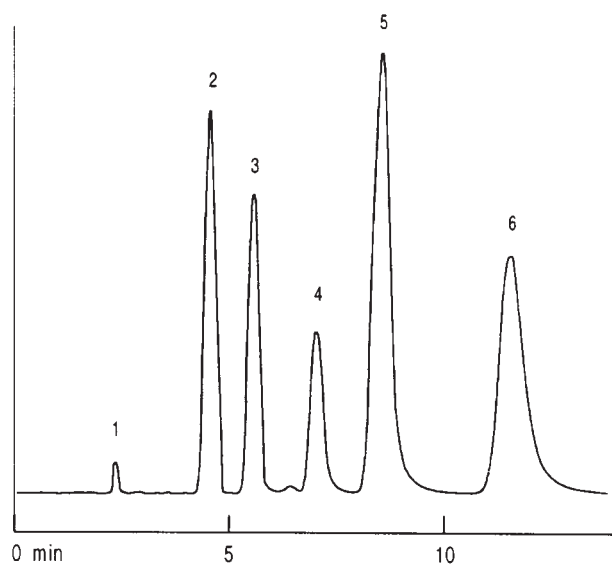

Carbamates

Analysis Conditions:

Column: ACT-1
 Eluent: 70:30 ACN:H₂O
 Flow rate: 0.5 mL/min
 Temperature: Ambient
 Detection: UV at 240 nm
 Injection: 20 μ L

Sample:

1. Oxamyl (5 μ g/mL)
2. Aldicarb (30 μ g/mL)
3. Carbofuran (30 μ g/mL)
4. Carbaryl (30 μ g/mL)
5. Propham (2.5 μ g/mL)
6. Methiocarb (12.5 μ g/mL)
7. Ferbam (9 μ g/mL)
8. ChloroIPC (9 μ g/mL)
9. EPTC (87.5 μ g/mL)

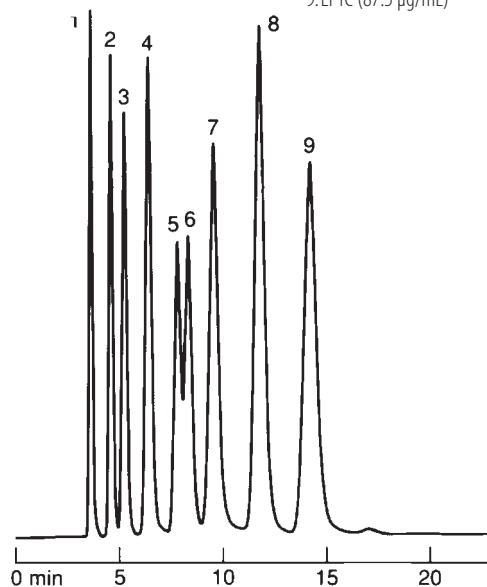

Separation of polar and Non-polar Compounds

Analysis Conditions:

Column: ACT-1
 Eluent: 60:40 ACN:H₂O
 Flow rate: 0.3 mL/min
 Temperature: Ambient
 Detection: UV at 254 nm

Sample:

1. Unknown
2. Phenol
3. Aniline
4. Acetophenone
5. Nitrobenzene
6. Toluene

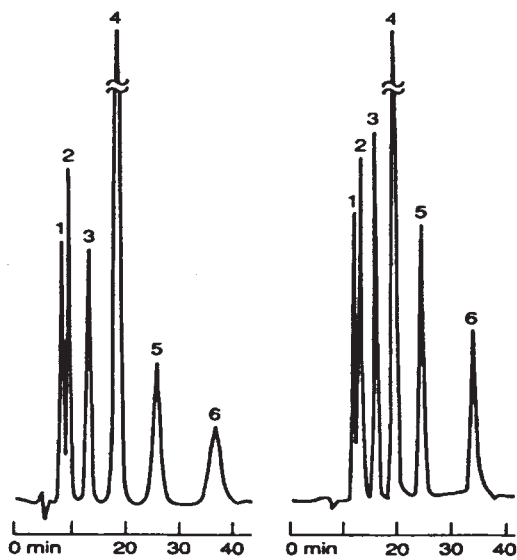

Tertiary Amines on Poly-RP C0

Analysis Conditions:

Column: Poly-RP C0
 Eluent: 0.1 M Ammonia in 80:20 ACN:H₂O
 Flow rate: 0.75 mL/min
 Temperature: Ambient
 Detection: UV at 210 nm

Sample: 0.05 μ L/mL of

1. Trimethylamine
2. Triethylamine
3. Diisopropylethy-lamine
4. Tripropylamine
5. Tribitylamine

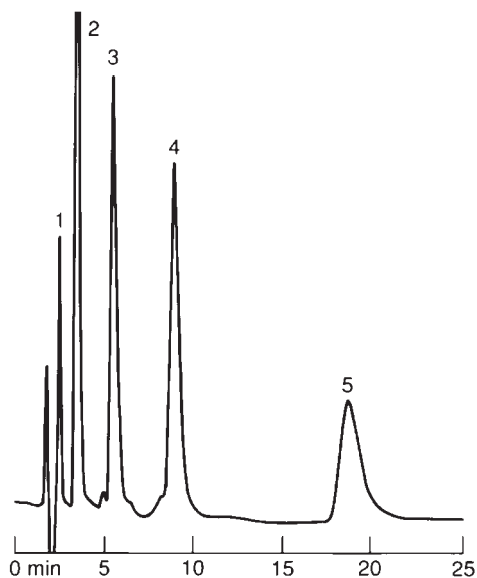

Comparison of ACT-1 with PRP-type Column

Analysis Conditions:

Column: ACT-1

Eluent: 80:20 Methanol: Water

Linear Velocity: 4.2 cm/min

Temperature: Ambient

Detection: UV at 254 nm

Sample:

1. Methylphenone
2. Ethylphenone
3. Propylphenone
4. Butylphenone
5. Pentylphenone

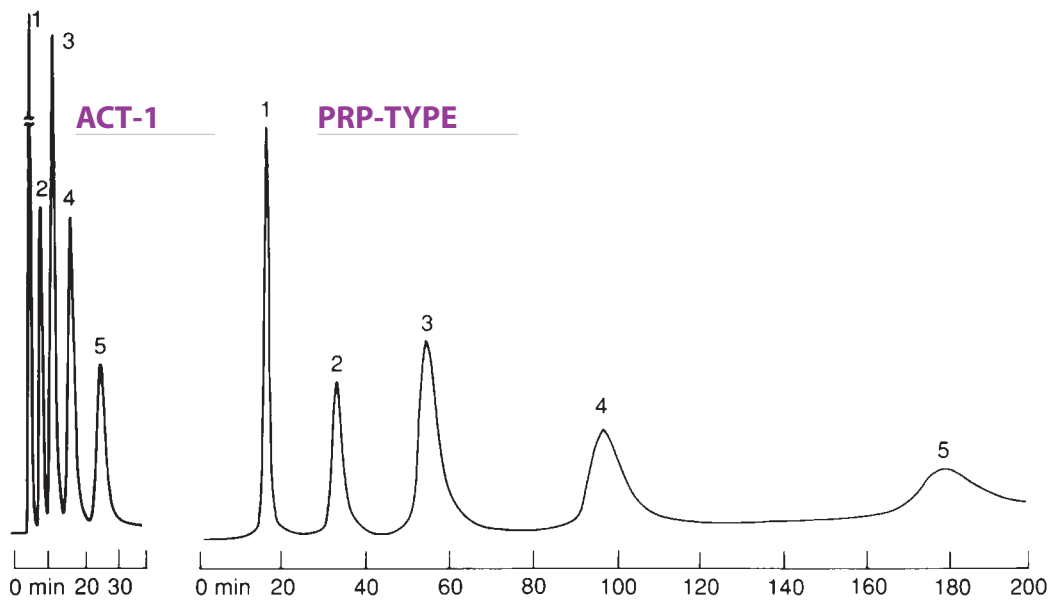

RPsep PRX-1 Column

(2.1 x 50mm)

P/N RPC-99-3014

(4.6 x 150mm)

P/N RPC-99-7514

(4.6 x 250mm)

P/N RPC-99-8514

- Porous PS/DVB Polymer
- Ideal for the separation of peptides and small molecules
- Works in entire pH range

RPsep PRX-1 Guard Kit

P/N RPC-99-2324

RPsep PRX-1 Guard Cartridge – 2/PK

P/N RPC-99-1314

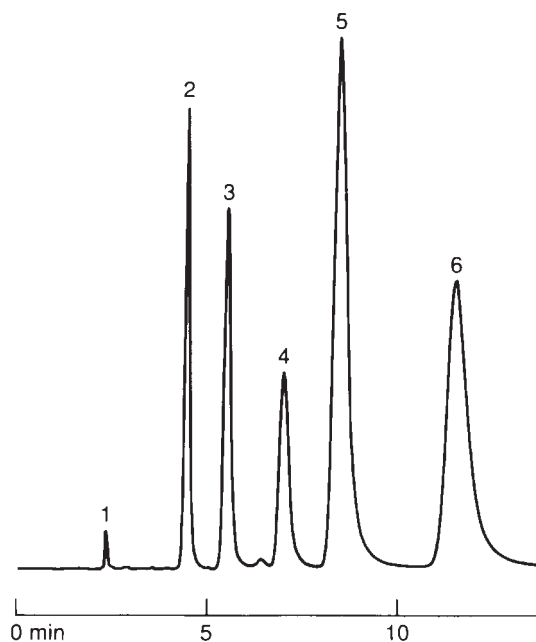
**RPsep ACT-1 C18 Column**

(2.1 x 50mm)

P/N RPC-99-3150

(2.1 x 150mm)

P/N RPC-99-7150

(4.6 x 150mm)

P/N RPC-99-7550

(4.6 x 50mm)

P/N RPC-99-3550

- Employs proprietary alkylation technology
- Very stable, highly efficient C18 adsorbant
- Can be used in pH range of 2-14

RPsep ACT-1 C18 Guard Kit

P/N RPC-99-2350

RPsep ACT-1 C18 Guard Cartridge – 2/PK

P/N RPC-99-2360

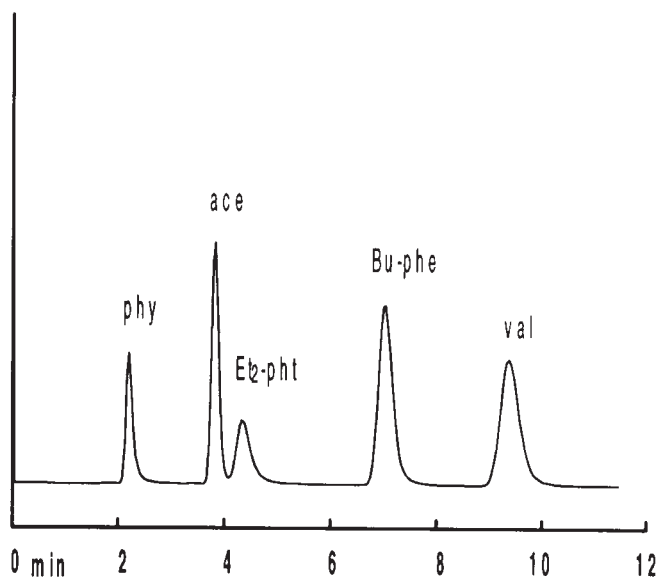
**RPsep Poly-RP Column**

(4.6 x 150mm)

P/N RPC-99-7551

- Non-alkylated PS/DVB sorbant
- 4 micron particle size for highest efficiency

RPsep Poly-RP Column Guard Kit

P/N RPC-99-2351

RPsep Poly-RP Column Guard Cartridge – 2/PK

P/N RPC-99-2361

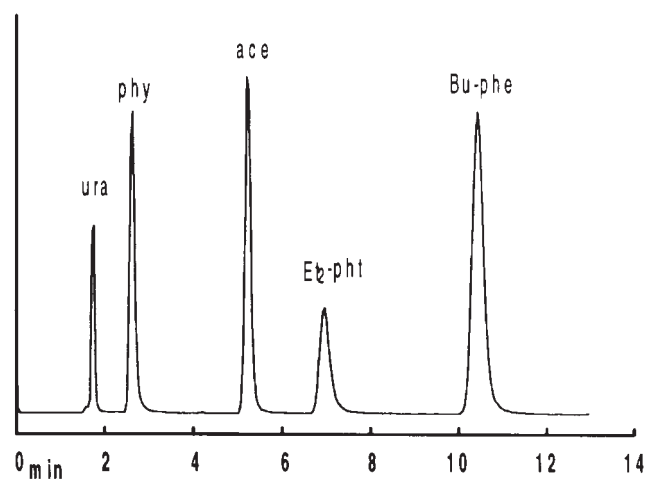

ION

Chromatography

Introduction

Ion Chromatography (IC) is the separation of inorganic and organic ionic species by ion exchange chromatography followed by suppressed conductivity detection. The technique was pioneered by Dow Chemical Company in 1974 and has grown in popularity since.

The species analyzed by IC include both anions and cations. The separation of anions is accomplished via anion exchange chromatography. The separations of cations are accomplished via cation exchange chromatography. Transgenomic provides a broad range of columns for the separation of both anions and cations.

The resins used for anion and cation exchange chromatography in IC employ a functionalized, macroporous polystyrene/divinyl benzene copolymer. Resins functionalized with quaternary alkyl or alkylnol ammonium groups are used with hydroxide or carbonate-based eluents for anion exchange IC. Resins functionalized with sulfonic acid or carboxylic acid groups are used with acidic eluents for cation exchange IC.

Features

The key features of the Transgenomic IC columns are:

- **Polymeric substrate**
- **Solvent compatibility**
- **High efficiency**
- **Reproducibility**
- **pH Stability from 0 to 14**

Column Selection

Transgenomic IC columns have been designed to run on a variety of systems. They are tested to be compatible with Ion Chromatographs from: Metrohm-Peak, Dionex, Hach-Lachat, and Alltech. The selectivities have been optimized to be compatible with many of the common IC columns currently available. This includes columns that meet the requirements of E.P.A. methods 300 parts a and b, and E.P.A. method 300.1.



Column Equivalents Guide

TRANSGENOMIC COLUMN	COMPETITIVE COLUMNS	APPLICATION
ICSep AN300	Dionex AS4A	F ⁻ , Cl ⁻ , NO ₂ ⁻ , Br ⁻ , NO ₃ ⁻ , HPO ₄ ²⁻ , SO ₄ ²⁻ , By E.P.A. Method 300.0(a)
ICSep AN1	Dionex AS9-HC	F ⁻ , Cl ⁻ , NO ₂ ⁻ , Br ⁻ , NO ₃ ⁻ , HPO ₄ ²⁻ , SO ₄ ²⁻ , Low molecular weight, Organic acids in medium to high ionic strength matrices Cr(III), Cr(VI) as CrO ₃ ⁻ , CrO ₄ ²⁻
ICSep ANSC	Dionex AS4A-SC	Polyvalent Phosphates, Arsenate, Sulfite Selenate, Arsenite, Selenite, F ⁻ , Cl ⁻ , NO ₂ ⁻ , Br ⁻ , NO ₃ ⁻ , HPO ₄ ²⁻ , SO ₄ ²⁻ , Low molecular weight, Organic acids
ICSep AN1SC	Dionex AS9-HC	F ⁻ , Cl ⁻ , NO ₂ ⁻ , Br ⁻ , NO ₃ ⁻ , HPO ₄ ²⁻ , SO ₄ ²⁻ , Low molecular weight, Organic acids in medium to high ionic strength matrices
ICSep AN2	Dionex AS14	Arsenate, Sulfite, Selenate, Arsenite, Selenite F ⁻ , Cl ⁻ , NO ₂ ⁻ , Br ⁻ , NO ₃ ⁻ , HPO ₄ ²⁻ , SO ₄ ²⁻ , Low molecular weight Organic acids
ICSep AN300B	Dionex AS9	F ⁻ , Cl ⁻ , NO ₂ ⁻ , Br ⁻ , NO ₃ ⁻ , HPO ₄ ²⁻ , SO ₄ ²⁻ , ClO ₂ ⁻ , ClO ₃ ⁻ , BrO ₃ ⁻
ICSep CN2	Dionex CS15	Li ⁺ , Na ⁺ , K ⁺ , Rb ⁺ , Cs ⁺ , Mg ²⁺ , Ca ²⁺ , NH ₄ ⁺ , Cu ²⁺ , Ni ²⁺ , Zn ²⁺ , Co ²⁺ , Cd ²⁺ , Pb ²⁺ , Mn ²⁺ , Fe ²⁺ , Fe ³⁺

Anions by E.P.A. Method 300.0(a)

Conditions

Column: ICSep AN300
 Eluent: 1.7mM Sodium Carbonate, 1.8mM Sodium Bicarbonate
 Flow rate: 2.0 mL/min
 Detection: suppressed conductivity

Sample:

1. Fluoride
2. Chloride
3. Nitrite
4. Bromide
5. Nitrate
6. Phosphate
7. Sulfate

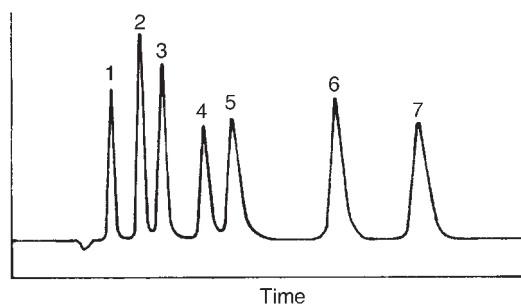

Anions by E.P.A. Method 300.1

Conditions

Column: ICSep AN300B
 Eluent: 3.5mM Sodium Carbonate
 Flow rate: 1.0 mL/min
 Detection: conductivity

Sample:

1. Fluoride
2. Chlorite
3. Bromate
4. Dichloroacetate
5. Chloride
6. Nitrite
7. Chlorate
8. Nitrate
9. Bromide
10. Phosphate
11. Sulfate

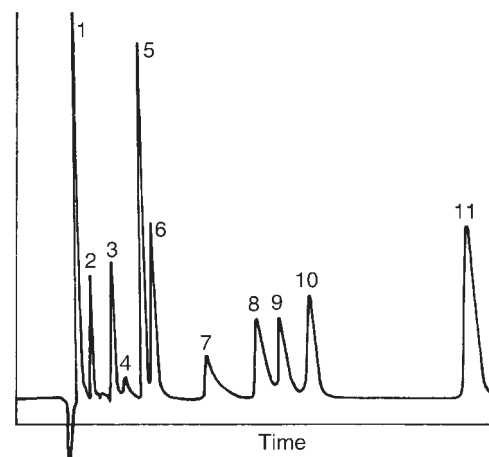

Anion Separation using ICsep ANSC

Conditions

Column: ICsep ANSC
 Eluent: 1.8mM Sodium Carbonate, 1.7mM Sodium Bicarbonate
 Flow rate: 1.2 mL/min
 Detection: suppressed conductivity

Sample:

1. Fluoride
2. Chloride
3. Nitrite
4. Bromide
5. Nitrate
6. Phosphate
7. Sulfate

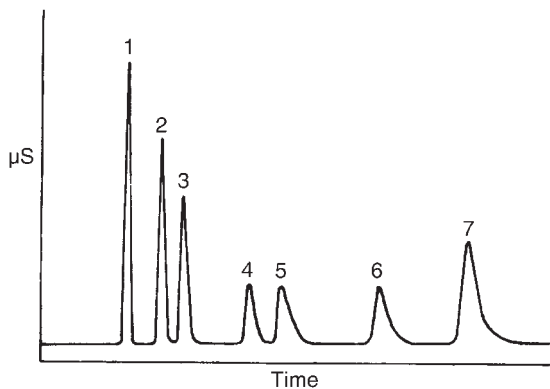

Determination of Perchlorate using ICsep ANSC

Conditions

Column: ICsep ANSC with guard
 Eluent: 30mM Sodium Hydroxide, 10mM Cyanophenol
 Flow rate: 1.2 mL/min
 Detection: suppressed conductivity

Sample:

1.4ppb ClO₄

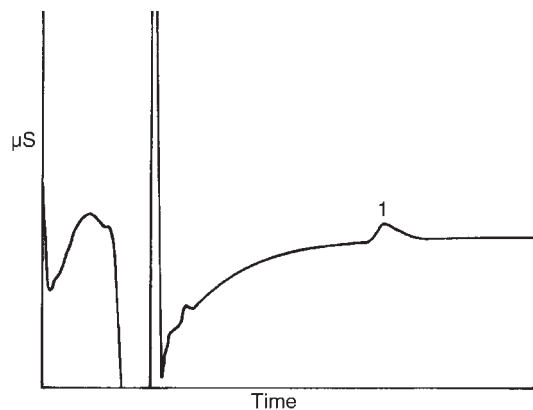

Cations using ICsep CN2

Conditions

Column: ICsep CN2
 Eluent: 0.1mM Ce (III)
 Flow rate: 1.0 mL/min
 Detection: UV @ 254nm

Sample:

1. 3ppm sodium
2. 3ppm ammonium
3. 5ppm potassium
4. 30ppm rubidium
5. 30ppm cesium
6. 10ppm magnesium
7. 10ppm calcium

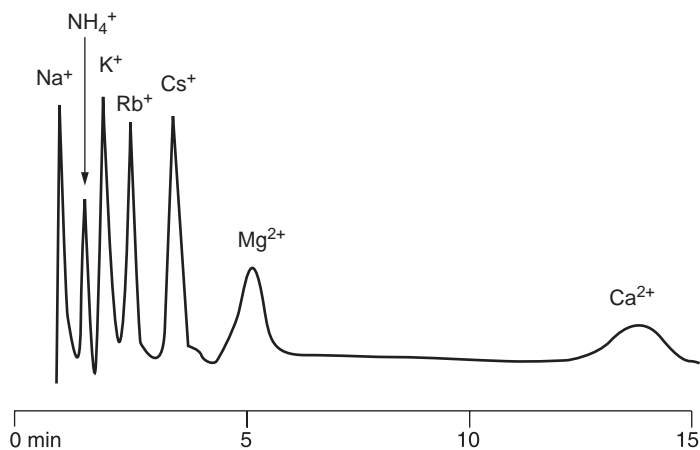

Ordering Information

DESCRIPTION	PART NUMBER
ICSep AN2, 4.6mm x 250mm	ANX-99-8515
ICSep AN2 Guard Column, 4.6mm x 50mm	ANX-99-3515
ICSep AN2 Guard Cartridges, 3/pk, 3.0mm x 10mm	ANX-99-0015
ICSep AN1, 4.6mm x 250mm	ANX-99-8511
ICSep AN1 Guard Column, 4.6mm x 50mm	ANX-99-3510
ICSep AN1 Guard Cartridges, 3/pk, 3.0mm x 10mm	ANX-99-0010
ICSep AN1-SC, 4.6mm x 250mm	ANX-99-8514
ICSep AN1-SC Guard Column, 4.6mm x 50mm	ANX-99-3514
ICSep AN1-SC Guard Cartridges, 3/pk, 3.0mm x 10mm	ANX-99-0014
ICSep AN300, 5.5mm x 150mm	ANX-99-7613
ICSep AN1 Guard Column, 4.6mm x 50mm	ANX-99-3510
ICSep AN1 Guard Cartridges, 3/pk, 3.0mm x 10mm	ANX-99-0010
ICSep AN300B, 4.6mm x 250mm	ANX-99-8516
ICSep AN300B Guard Column, 4.6mm x 50mm	ANX-99-3516
ICSep AN300B Guard Cartridges, 3/pk, 3.0mm x 10mm	ANX-99-0016
ICSep ANSC, 4.6mm x 250mm	ANX-99-8512
ICSep ANSC Guard Column, 4.6mm x 50mm	ANX-99-3512
ICSep ANSC Guard Cartridges, 3/pk, 3.0mm x 10mm	ANX-99-0012
ICSep ION-120, 4.6mm x 120mm	ANX-99-6550
ICSep ION-120 Guard Kit, 4.0mm x 24mm	ANX-99-2350
ICSep ION-120 Guard Cartridges, 3/pk, 4.0mm x 24mm	ANX-99-0090
ICSep CN2, 3.2mm x 100mm	CTX-99-5250
ICSep CN2 Guard Cartridges, 2/pk, 3.0mm x 10mm	CTX-99-1350
ICSep CN2 FA, 4.6mm x 50mm	CTX-99-3550
ICSep CN2 Guard Cartridges, 2/pk, 3.0mm x 10mm	CTX-99-1350



GUARD-DISC[®] PROTECTION *System*

Guard-Disc System

The Transgenomic Guard-Disc System is a patented column protection system that is designed to provide the protection capabilities of a guard column without adding any extra volume that might interfere with chromatographic separation.

The Guard-Disc System is comprised of a disc, which is available in a variety of functionalities, and a disc holder that couples directly to the column.

The disc is a PEEK ring that contains a functionalized chromatographic membrane. This chromatographic membrane is available in a variety of stationary phases for both HPLC and Ion Chromatography applications.

Phases

The stationary phases that Guard-Discs Systems are available in include:

- **C18**
- **C8**
- **Styrene/DVB**
- **Anion Exchange**
- **Cation Exchange**

It is these functional groups that bind the contaminants that would otherwise be trapped on your analytical column.

Double Protection

Transgenomic Guard-Disc Systems are porous as well. Not only do they bind species that may contaminate your analytical column, they also filter out particulates that would otherwise be trapped on your analytical column. The Transgenomic Guard-Disc System provides double protection for your chromatographic column.



Guard-Disc System Characteristics

Membrane Functionality	Application	Porosity (µm)	Solvent Compatibility	pH Range
C18-A	Reversed Phase	0.2	All	2-8
C18-B	Reversed Phase	0.8	Acetonitrile Methanol	2-8
C8	Reversed Phase	0.2	All	2-8
S/DVB	Reversed Phase	0.2	All	1-13
ANEX	Anion Exchange	0.2	All	1-13
CATEX	Anion Exchange	0.2	All	1-13

TRANSGENOMIC GUARD *Discs*[®]*Ion Exchangers***ANEX Guard-Disc – (10/pk)**

P/N GRD-99-0704

CATEX Guard-Disc – (10/pk)

P/N GRD-99-0705

*Adsorbants***C18A Guard-Disc (10/pk)**

P/N GRD-99-0701

C18B Guard-Disc (10/pk)

P/N GRD-99-0731

C8 Guard-Disc (10/pk)

P/N GRD-99-0702

S/DVB Guard-Disc (10/pk)

P/N GRD-99-0706

TRANSGENOMIC GUARD *Disc*[®] Holders**Guard-Disc Direct Holder 1**

(Parker Type)

P/N AXC-99-0002

Guard-Disc Direct Holder 2

(Waters Type)

P/N AXC-99-0003

**Guard-Disc
Universal Holder 1N**

(Universal)

P/N AXC-99-0004

Extraction

Transgenomic POLYSorb™ Products for Solid Phase Extraction

Solid Phase Extraction (SPE) is a sample preparation technique that is employed to clean up or concentrate samples prior to analysis. SPE can be used to clean-up samples by removing interferences that would otherwise compromise analysis. It can be used to concentrate by allowing a large volume of sample to be reduced into a small elution volume. Compared to other sample preparation techniques, such as liquid-liquid extraction, SPE provides cleaner extracts with high recoveries. SPE is also faster and uses less solvent which saves money.

Modes

SPE tubes can be used in two modes:

1. In the flow-through mode the sample can be passed through the tube. While passing through the tube, the contaminants present are retained while the analyte of interest is allowed to pass through. The steps for this mode are 1) Load the sample into the tube 2) Wash to elute the analyte of interest.
2. In the selective elution mode the sample is passed through the tube. But in this mode, the analyte of interest is retained while contaminants pass through. After the sample is loaded onto the column, the analyte of interest is selectively eluted by choosing elution conditions that will elute the analyte from the column while retaining interfering components. The steps used with this mode are 1) Load the sample onto the column 2) Wash through weakly retained or unretained contaminants 3) Elute the analyte of interest.

The most common SPE packing are polar adsorbants. These adsorbants are used to remove organic interferences from samples. Also, commonly used are ion exchangers to remove charged species as interferences. Transgenomic offers products for both adsorption and ion exchange.

Key Features of Transgenomic SPE products

As with all of Transgenomic's chromatography products, the SPE products are all based on polymeric resins. Polymer-based resins are used because of the broad pH range available and the chemical and physical stability of the materials. These cartridges are ideally suited for cleaning up samples in tough matrices.

Transgenomic POLYSorb cartridges provide very high loading capacities to accommodate for concentrated samples. POLYSorb cartridges also provide excellent selectivity even for trace level analysis.

POLYSorb Cartridges in the format you need

Transgenomic POLYSorb cartridges are provided in three stationary phase formats:

- **Unmodified Poly-[styrene/divinylbenzene] (PS/DVB)**
- **Alkylated (C18) PS/DVB**
- **Sulfonated PS/DVB**

Transgenomic offers each of these cartridges in either 100mg or 400mg tubes, or we can custom pack in sizes to meet your specific needs.

POLYSorb tubes are compatible with off-the-shelf SPE vacuum manifolds, automated workstations or other commonly used accessories.

Extraction of Organic Acids from Burgundy Wine with ACT-1

Sample Preparation:

Dilute wine 1:10 with distilled water

Conditioning Step:

Wet tube with 1 mL of methonal followed by 1 mL of 10:90 methonal:water

Sample Addition:

Load 500 μ L of dilute wine

Wash Step:

1.0 mL of water

Elution Step:

1.0 mL of 0.05 N H_2SO_4

Analysis Conditions:

Column: ION-300

Eluent: 0.01 N H_2SO_4

Flow rate: 0.5 mL/min

Temperature: 60°C

Detection: UV at 214 nm

Injection: 20 μ L

Sample:

1. Citric Acid
2. Tartaric Acid
3. Glucose
4. Malic Acid
5. Fructose
6. Glycerol
7. Succinic Acid
8. Acetic Acid

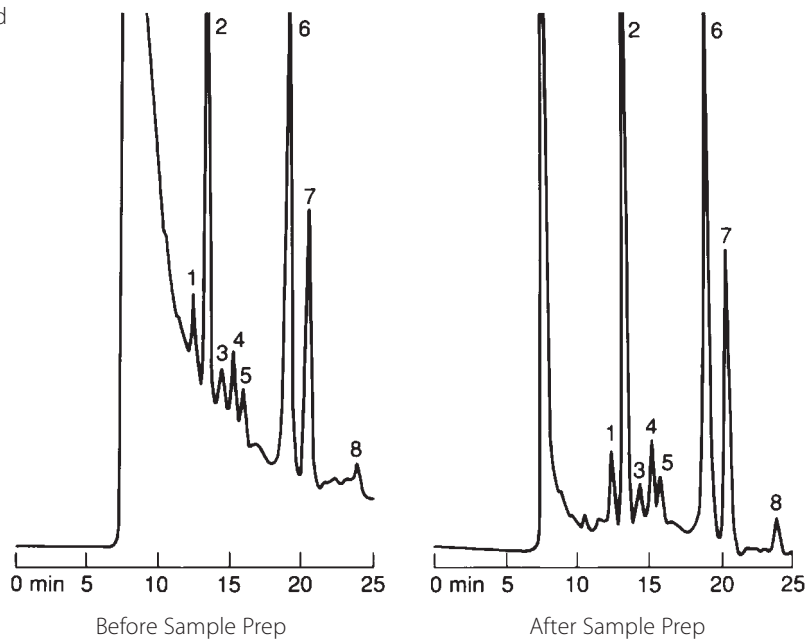

POLYSorb ACT-1, C18, 100mg

(100/box)

P/N SPE-99-0100

POLYSorb ACT-1, C18, 400mg

(50/box)

P/N SPE-99-0101

- Patented, Octadecyl-Alklyated PS/DVB
- Ideal for removal of polar compounds
- Stable over pH 0-14, very rugged

POLYSorb, MP-3, Highly Sulfonate, 100mg

(100/box)

P/N SPE-99-0104

POLYSorb, MP-3, Highly Sulfonated, 400mg

(50/box)

P/N SPE-99-0105

- pH stable cation exchange resin
- Ideal for removing amines
- Remove cations from ICP analysis

POLYSorb, MP-DVB, PS/DVB 100mg

(100/box)

P/N SPE-99-0108

POLYSorb, MP-DVB,PS/DVB 400mg

(50/box)

P/N SPE-99-0109

- Non-functionalized styrene-divinylbenzene
- Ideal for removing polar compounds
- pH stable from 0-14
- Also available in bulk

BULK POLYMERIC *Resin*

Transgenomic has scale-up in mind every time we develop a new resin. The resin in any column discussed in this catalogue is also available in bulk. This allows you to pack your own analytical columns, then quickly and easily scale your analytical application to semi-prep and preparative scales without redevelopment.

If we do not have the resin or particle size that you need, simply call. We have over 20 years experience in the development of polymer materials for analytical and preparative chromatography applications; allow us to put our expertise to work for you.



BUFFERS and SOLVENTS FOR *HPLC*

Buffers and Solvents for Reversed Phase Chromatography

Part Number	Description	Size
56011	Acetonitrile, HPLC Grade	1 liter
700002	Water, HPLC Grade	4 liter
553303	Triethylammonium acetate solution, 2M	200 mL
SP5890	Triethylammonium acetate solution, 2M	6 x 200 mL

Amino Acid Analysis Buffers

Part Number	Description	Size
AAA-99-4086	Sodium Diluent Na200	4 liter
AAA-99-4081	Sodium Eluent Na315	4 liter
AAA-99-4096	Sodium Eluent Na740	4 liter
AAA-99-4085	Sodium Regenerant RG011	4 liter

**Custom Amino Acid Buffers are available for your analysis,
please contact Transgenomic for further information**



Hardware

Column Coupler

The patented Column Coupler was developed for the demanding constraints of high efficiency HPLC columns. The Column Coupler permits the quick and easy connection of two analytical HPLC columns in series, or direct connection between a Valco injection valve and an analytical column. Seals are rated to 5,000psi

The unit is a precision-machined, double-ended PEEK connector with 10-32 threads and a non-wetted Delrin® knurled body. The inert composition and the large knurled handle allow easy, finger-tight connections and leakproof seal to 5,000psi. The 0.010" through-hole minimizes extra column volume effects and is compatible with the demanding constraints imposed with use of 3µm packing and microbore HPLC. These couplers are not capable of universal applications since the tip sizes are fixed



Guard Cartridge Holder

The Universal Guard Cartridge Holder was designed for use with Transgenomic guard cartridges.

Ordering Information:

Part Number	Description
282013	Column Coupler, PEEK
AXC-99-1300	Universal Guard Cartridge Holder, 4.0mm x 24mm

The unit is a stainless steel body with dimensions of 4.0mm x 24mm

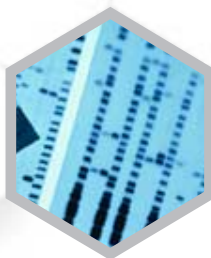

COLUMN *Index*

Amino Acid Columns

PAGE

Transgenomic Na +	6
Transgenomic Li +	6
Transgneomic Na + Column for System Gold	6
AMINOSep AA-911	7
AMINOSep AA-511	7
AMINOSep AA-511High Speed	7

Carbohydrate Analysis Columns

PAGE

CARBOSep CHO-620	16
CARBOSep CHO-682	16
CARBOSep CHO-820	16
CARBOSep CHO-611 OH	17
CARBOSep CHO-611	17
CARBOSep CHO-411	17
CARBOSep USP-L19	18
CARBOSep COREGEL-87C	18
CARBOSep COREGEL-87K	18
CARBOSep COREGEL-87N	19
CARBOSep COREGEL-87P	19
CARBOSep COREGEL-87MM	20
CARBOSep COREGEL-42Ag	20

Organic Acid Analysis Columns

PAGE

ICSep COREGEL-87H	27
ICSep ION-300	28
ICSep COREGEL-107H	29
ICSep ORH-801	30
ICSep WA-1 Wine Analysis	30
ICSep ION-310	31
ICSep ARH-601	31
ICSep COREGEL-64H	31

Polymeric Reversed Phase Columns

PAGE

RPSep POLYRP C0	37
RPSep ACT-1	37
RPSep PRX-1	37

Ion Analysis Columns

PAGE

ICSep AN1	41
ICSep AN1S	41
ICSep AN2	41
ICSep ANSC	41
ICSep AN300	41
ICSep AN300B	41
ICSep ION-120	41
ICSep CN2	41





TRANSGENOMIC®
BIOCONSUMABLES™

To order catalog items:

TRANSGENOMIC CORPORATE HEADQUARTERS

12325 Emmet Street
Omaha, NE, USA 68164

Tel: **1-888-233-9283**

Fax: **1-402-452-5401**

E-mail: **orders@transgenomic.com**

For technical support:

TRANSGENOMIC – SAN JOSE OFFICE

2032 Concourse Drive
San Jose, CA 95131

Tel: **1-800-605-0267**

Fax: **1-408-432-3231**

www.transgenomic.com

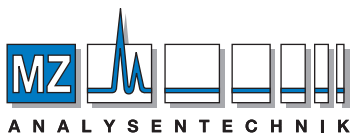

A N A L Y S E N T E C H N I K

AUTHORIZED DISTRIBUTOR

MZ-Analysentechnik GmbH, Barcelona-Allee 17 • D-55129 Mainz

Tel +49 6131 880 96-0, Fax +49 6131 880 96-20

e-mail: info@mz-at.de, www.mz-at.de